



chinese english



OVER 6,000 WORDS
AND PHRASES

BILINGUAL
DICTIONARY

VISUAL



Bilingual
VISUAL
dictionary

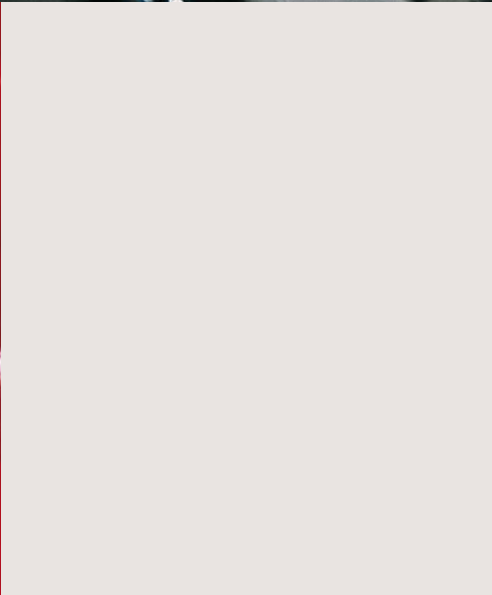
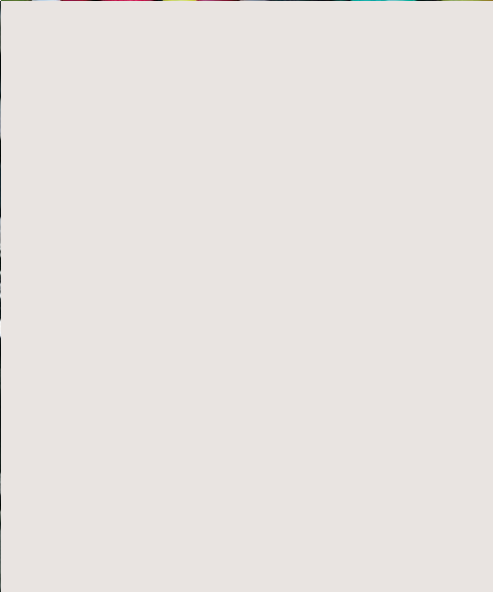
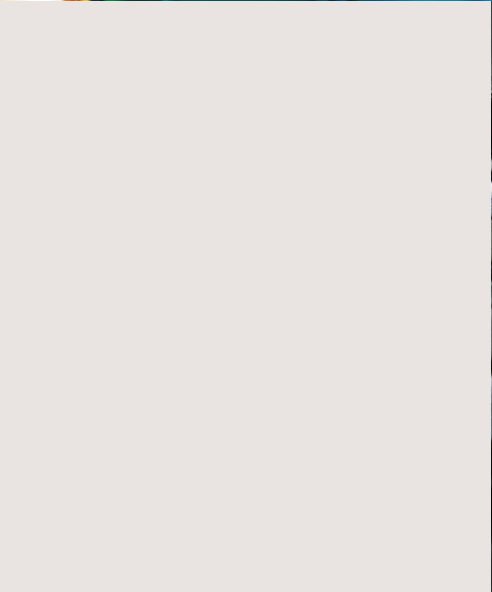

Bilingual **VISUAL** dictionary



A DORLING KINDERSLEY BOOK

London, New York, Melbourne, Munich, Delhi

Senior Editor Angela Wilkes
Senior Art Editor Vicky Short
DTP Designer Deeraj Arora
DTP Coordinator Balwant Singh
Production Editor Lucy Baker
Production Controller Rita Sinha
Managing Art Editor Christine Keilty

Designed for Dorling Kindersley by WaltonCreative.com
Art Editor Colin Walton, assisted by Tracy Musson
Designers Peter Radcliffe, Earl Neish, Ann Cannings
Picture Research Marissa Keating

Language content for Dorling Kindersley by
g-and-w PUBLISHING

Managed by Jane Wightwick, Shuang Zou
Translation by Foreign Language
Teaching & Research Press
Pinyin transcription by Lin Jing

First published in Great Britain in 2008 by
Dorling Kindersley Limited,
80 Strand, London WC2R 0RL

A Penguin Company

2 4 6 8 10 9 7 5 3 1

Copyright © Dorling Kindersley Limited 2008
Copyright Chinese translation © Foreign Language
Teaching & Research Press (FLTRP) 2008

All rights reserved. No part of this publication may be reproduced, stored in a retrieval system, or transmitted in any form or by any means, electronic, mechanical, photocopying, recording, or otherwise, without the prior written permission of the copyright owner.

A CIP catalogue record for this book is available from
the British Library

ISBN 978 1 4053 2916 3

Printed by L. Rex Printing Co. Ltd, China

Discover more at

www.dk.com

目录 mùlù contents



42

健康
jiànkāng
health



146

外出就餐
wàichūjiùcān
eating out



252

休闲
xiūxián
leisure



6

词典介绍
cídiǎnjièshào
about the dictionary



8

使用说明
shǐyòng shuōmíng
how to use this book



10

人
rén
people



28

外表
wàibiǎo
appearance



56

家居
jiājū
home



92

服务
fúwù
services



102

购物
gòuwù
shopping



116

食物
shíwù
food



160

学习
xuéxí
study



170

工作
gōngzuò
work



192

交通运输
jiāotōng yùnshū
transport



218

体育运动
tǐyù yùndòng
sports



278

环境
huánjīng
environment



302

日常便览
rìcháng biànlǎn
reference



324

索引
suǒyǐn
index



360

鸣谢
míngxiè
acknowledgments

人 rén • people

人体 réntǐ body	12
面部 miànbù face	14
手 shǒu hand	15
脚 jiǎo foot	15
肌肉 jīròu muscles	16
骨骼 gǔgé skeleton	17
内脏 nèizàng internal organs	18
生殖器官 shēngzhíqìguān reproductive organs	20
家庭 jiāting family	22
人际关系 rénjìguānxì relationships	24
情感 qínggǎn emotions	25
人生大事 rénshēngdàshì life events	26

外表 wàibiǎo • appearance

童装 tóngzhuāng children's clothing	30
男装 nánzhuāng men's clothing	32
女装 nǚzhuāng women's clothing	34
配饰 pèishì accessories	36
头发 tóufà hair	38
美容 měiróng beauty	40

健康 jiànkāng • health

疾病 jíbìng illness	44
医生 yīshēng doctor	45
创伤 chuāngshāng injury	46
急救 jíjiù first aid	47
医院 yīyuàn hospital	48
牙医 yáyī dentist	50
配镜师 pèijìngshī optician	51
怀孕 huáiyùn pregnancy	52

分娩 fēnmiǎn childbirth	53
替代疗法 tìdài liáofǎ alternative therapy	54

家居 jiājū • home

房屋 fángwū house	58
室内系统 shìnèi xìtǒng internal systems	60
起居室 qǐjūshì living room	62
餐厅 cāntīng dining room	64
厨房 chúfáng kitchen	66
厨具 chújù kitchenware	68
卧室 wòshì bedroom	70
浴室 yùshì bathroom	72
育婴室 yùyīngshì nursery	74
洗衣间 xǐyījiān utility room	76
工作间 gōngzuòjiān workshop	78
工具箱 gōngjùxiāng toolbox	80
装修 zhuāngxiū decorating	82
花园 huāyuán garden	84
花园植物 huāyuánzhíwù garden plants	86
园艺工具 yuányì gōngjù garden tools	88
园艺 yuányì gardening	90

服务 fúwù • services

急救 jíjiù emergency services	94
银行 yínháng bank	96
通讯 tōngxùn communications	98
旅馆 lǚguǎn hotel	100

购物 gòuwù • shopping

购物中心 gòuwùzhōngxīn shopping centre	104
百货商店 bǎihuò shāngdiàn	105

department store	
超级市场 chāojí shìchǎng supermarket	106
药店 yàodiàn chemist	108
花店 huādiàn florist	110
报刊亭 bàokāntíng newsagent	112
糖果店 tángguǒdiàn confectioner	113
其他店铺 qítā diànpù other shops	114

食物 shíwù • food

肉 ròu meat	118
鱼 yú fish	120
蔬菜 shūcài vegetables	122
水果 shuǐguǒ fruit	126
谷物及豆类 gǔwùjídòulèi grains and pulses	130
香草和香辛料 xiāngcǎo hé xiāngxīnliào herbs and spices	132
瓶装食品 píngzhuāngshípǐn bottled foods	134
乳制品 rǔzhǐpǐn dairy produce	136
面包和面粉 miànbāo hé miànfěn breads and flours	138
糕点 gāodiǎn cakes and desserts	140
熟食店 shúshídiàn delicatessen	142
饮料 yǐnliào drinks	144

外出就餐 wàichū jiùcān • eating out

咖啡馆 kāfēiguǎn café	148
酒吧 jiǔbā bar	150
餐馆 cānguǎn restaurant	152
快餐 kuàicān fast food	154
早餐 zǎocān breakfast	156
正餐 zhèngcān dinner	158

学习 xuéxí • study

学校 xuéxiào school	162
数学 shùxué maths	164
科学 kēxué science	166
高等院校 gāoděngyuànxìào college	168

工作 gōngzuò • work

办公室 bàngōngshì office	172
计算机 jìsuànjī computer	176
媒体 méitǐ media	178
法律 fǎlǜ law	180
农场 nóngchǎng farm	182
建筑 jiànzhù construction	186
职业 zhíyè occupations	188

**交通运输 jiāotōng
yùnsū • transport**

道路 dàolù roads	194
公共汽车 gōnggòngqìchē bus	196
汽车 qìchē car	198
摩托车 mótuōchē motorbike	204
自行车 zìxíngchē bicycle	206
列车 lièchē train	208
飞机 fēijī aircraft	210
机场 jīchǎng airport	212
船 chuán ship	214
港口 gǎngkǒu port	216

**体育运动 tǐyùyùndòng
• sports**

美式橄榄球 měishì gǎnlǎnqiú American football	220
英式橄榄球 yīngshì gǎnlǎnqiú rugby	221
足球 zúqiú soccer	222

曲棍类运动 qūgùnlèi yùndòng hockey	224
板球 bǎnqiú cricket	225
篮球 lánqiú basketball	226
棒球 bàngqiú baseball	228
网球 wǎngqiú tennis	230
高尔夫球 gāo'ěrfūqiú golf	232
田径运动 tiánjìng yùndòng athletics	234
格斗运动 gédòu yùndòng combat sports	236
游泳 yóuyǒng swimming	238
帆船运动 fānchuán yùndòng sailing	240
马上运动 mǎshàng yùndòng horse riding	242
钓鱼 diàoyú fishing	244
滑雪 huáxuě skiing	246
其他运动 qítāiyùndòng other sports	248
健身 jiànshēn fitness	250

休闲 xiūxián • leisure

剧院 jùyuàn theatre	254
乐队 yuèduì orchestra	256
音乐会 yīnyuèhuì concert	258
观光 guānguāng sightseeing	260
户外活动 hùwàihuódòng outdoor activities	262
海滩 hǎitān beach	264
露营 lùyíng camping	266
家庭娱乐 jiātīngyúlè home entertainment	268
摄影 shèyǐng photography	270
游戏 yóuxì games	272
工艺美术 gōngyīměishù arts and crafts	274

**环境 huánjìng
• environment**

宇宙空间 yǔzhòukōngjiān space	280
地球 dìqiú Earth	282
地貌 dìmào landscape	284
天气 tiānqì weather	286
岩石 yánshí rocks	288
矿物 kuàngwù minerals	289
动物 dòngwù animals	290
植物 zhíwù plants	296
城镇 chéngzhèn town	298
建筑 jiànzhù architecture	300

**日常便览 rìcháng
biànlǎn • reference**

时间 shíjiān time	304
日历 rìlì calendar	306
数字 shùzì numbers	308
度量衡 dùliáng Héng weights and measures	310
世界地图 shìjiè dìtú world map	312
小品词与反义词 xiǎopǐncí yǔ fǎnyìcí particles and antonyms	320
常用语 cháng yòngyǔ useful phrases	322

词典介绍

图片的应用经研究有助于对信息的理解和记忆。本着这个原则，这本有着丰富图片注释的英中双语词典包含了范围很广的词汇。

这本词典按照情景划分章节，从饮食到健身，从家居到工作，从太空到动物世界，包括了日常生活的所有细节。从这本词典中你也可以找到额外的常用词汇和词组以便口语练习和词汇量的扩大。

这本词典实用，生动，易用。对所有对语言有兴趣的人来说是一个重要的参考工具。

注意事项

本词典中的中文汉字同中华人民共和国官方汉字一样为简体汉字。

本词典为普通话注音，注音标记为拼音。拼音是中国人和中文学生最熟悉的一种音标。四声的变化也在拼音的结构中显示。

所有词语项都是以同样的顺序展示 - 文字，拼音，英文。例如：

午餐	安全带
wǔcān	ānquándài
lunch	seat belt

动词在英文词尾以 (v) 作为标记。例如：

收获 shōuhuò | **harvest (v)**

所有词汇在书后也有总目录可以查阅。在总目录里你可以通过查询英文，或者查询拼音找到相应的页数。这样可以很顺利地找到和拼音或英文相对应的中文文字翻译。

about the dictionary

The use of pictures is proven to aid understanding and the retention of information. Working on this principle, this highly-illustrated English-Chinese bilingual dictionary presents a large range of useful current vocabulary.

The dictionary is divided thematically and covers most aspects of the everyday world in detail, from the restaurant to the gym, the home to the workplace, outer space to the animal kingdom. You will also find additional words and phrases for conversational use and for extending your vocabulary.

This is an essential reference tool for anyone interested in languages – practical, stimulating, and easy-to-use.

A few things to note

The Chinese in the dictionary is presented in simplified Chinese characters, as used in the People's Republic of China.

The pronunciation included for the Chinese is given in the Mandarin dialect and is shown in Pinyin, the standard romanization familiar to most native speakers and learners of Chinese. Accents showing the Chinese tones are included on the Pinyin.

The entries are always presented in the same order – Chinese, Pinyin, English – for example:

午餐	安全带
wǔcān	ānquándài
lunch	seat belt

Verbs are indicated by a (v) after the English, for example:

收获 shōuhuò | **harvest (v)**

Each language also has its own index at the back of the book. Here you can look up a word in either English or Pinyin and be referred to the page number(s) where it appears. To reference the Chinese characters for a particular word, look it up in the Pinyin or English index and then go to the page indicated.



使用说明

不论你学习语言的目的是工作，兴趣，为旅行做准备还是仅仅在已学语言的基础上扩大词汇量，这本词典都是你语言学习的重要工具。你可以多方面地去运用它。

在学习一种新的语言的时候，注意同源词汇（即在不同语言中相似的词汇）和衍生词汇（即只在某种语言中有相似根源的词汇）。你可以发现语言和语言之间的联系。例如说，英文从中文中引用了一些关于食品的词汇，而同时也输出了一些关于科技和流行文化的词汇。

实用技巧

- 当你设身处地在家，工作场所或者学校的时候，试着看相对应自己所在环境的章节。这样一来你可以合上书，环视四周看看自己可以识别多少事物。
- 为自己做一些词汇卡片，一面英文一面为中文和汉语拼音。时常携带这些卡片并且测试自己的记忆。记住每次测试之前要打乱卡片的顺序。
- 挑战自己尝试用某一页上的所有词汇写一个小故事，一封信或者一段对话。这样不但可以帮助你牢记这些词汇，而且可以帮助你记住它们的拼写。如果你想尝试写一篇长一点的文章，那么以至少含有2-3个词的句子为起点。
- 如果你有很强的视觉记忆，试着将书上的内容画出来或者在纸上诠释出来，然后合上书，在已有的图形下面填充词汇。
- 一旦你变得更加自信，从中文目录中任意找一些词汇，检查自己是否在翻阅到相关页之前能知道其词意。

how to use this book

Whether you are learning a new language for business, pleasure, or in preparation for a holiday abroad, or are hoping to extend your vocabulary in an already familiar language, this dictionary is a valuable learning tool which you can use in a number of different ways.

When learning a new language, look out for cognates (words that are alike in different languages) and derivations (words that share a common root in a particular language). You can also see where the languages have influenced each other. For example, English has imported some terms for food from Chinese but, in turn, has exported some terms used in technology and popular culture.

Practical learning activities

- As you move about your home, workplace, or college, try looking at the pages which cover that setting. You could then close the book, look around you and see how many of the objects and features you can name.
- Make flashcards for yourself with English on one side and Chinese/Pinyin on the other side. Carry the cards with you and test yourself frequently, making sure you shuffle them between each test.
- Challenge yourself to write a story, letter, or dialogue using as many of the terms on a particular page as possible. This will help you retain the vocabulary and remember the spelling. If you want to build up to writing a longer text, start with sentences incorporating 2-3 words.
- If you have a very visual memory, try drawing or tracing items from the book onto a piece of paper, then close the book and fill in the words below the picture.
- Once you are more confident, pick out words in the foreign language index and see if you know what they mean before turning to the relevant page to check if you were right.







人 rén
people

人体 réntǐ • body

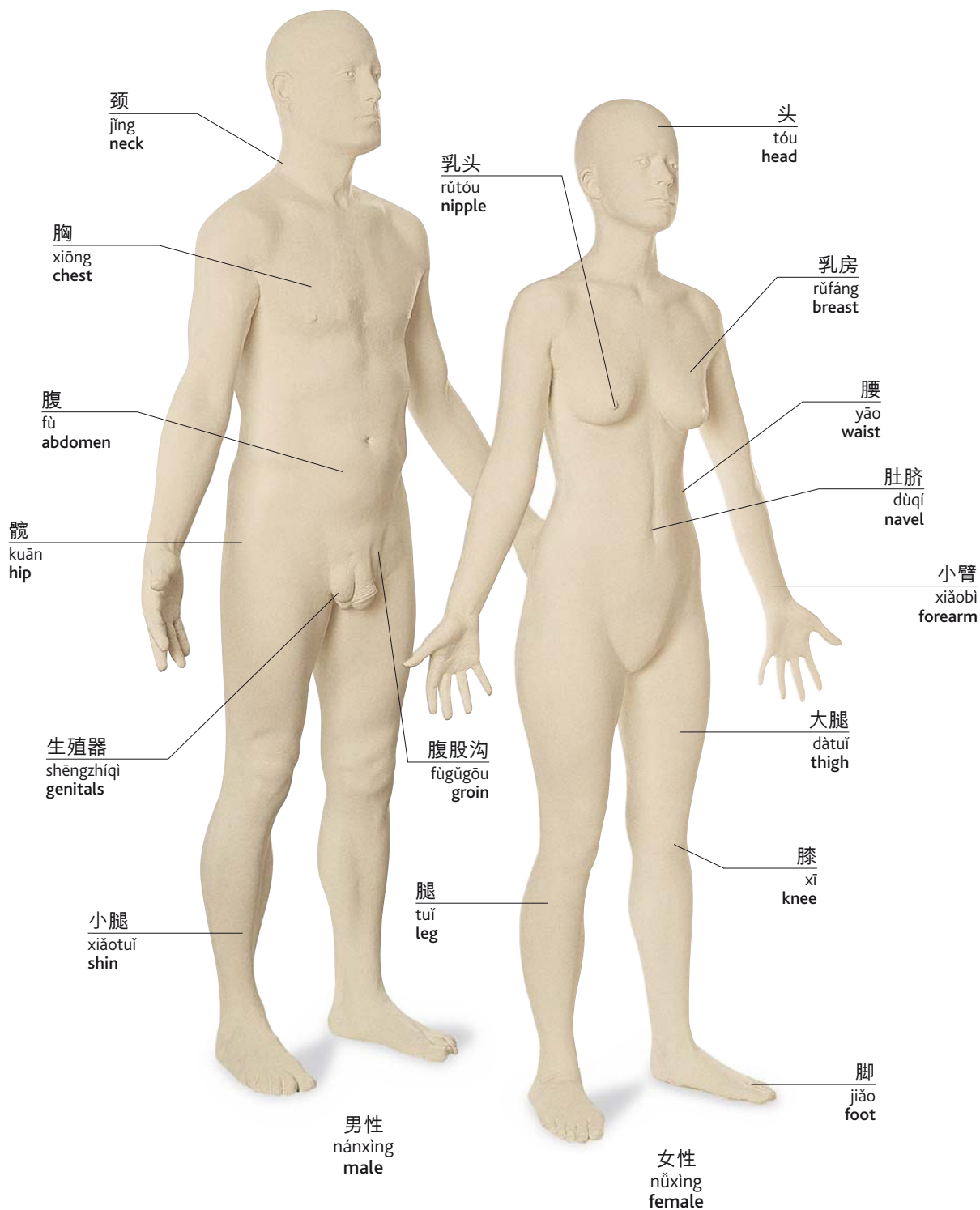

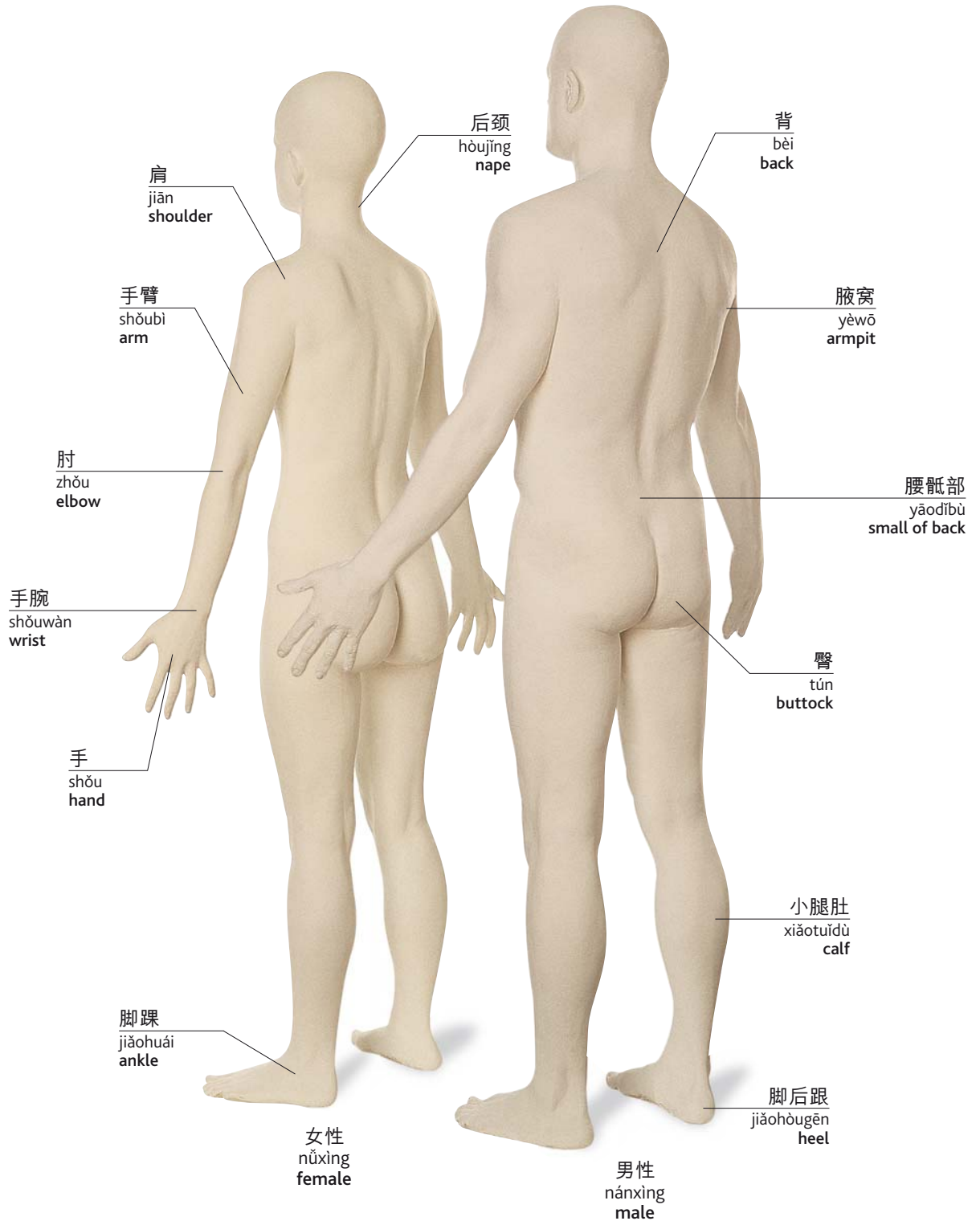

面部 miànbù • face

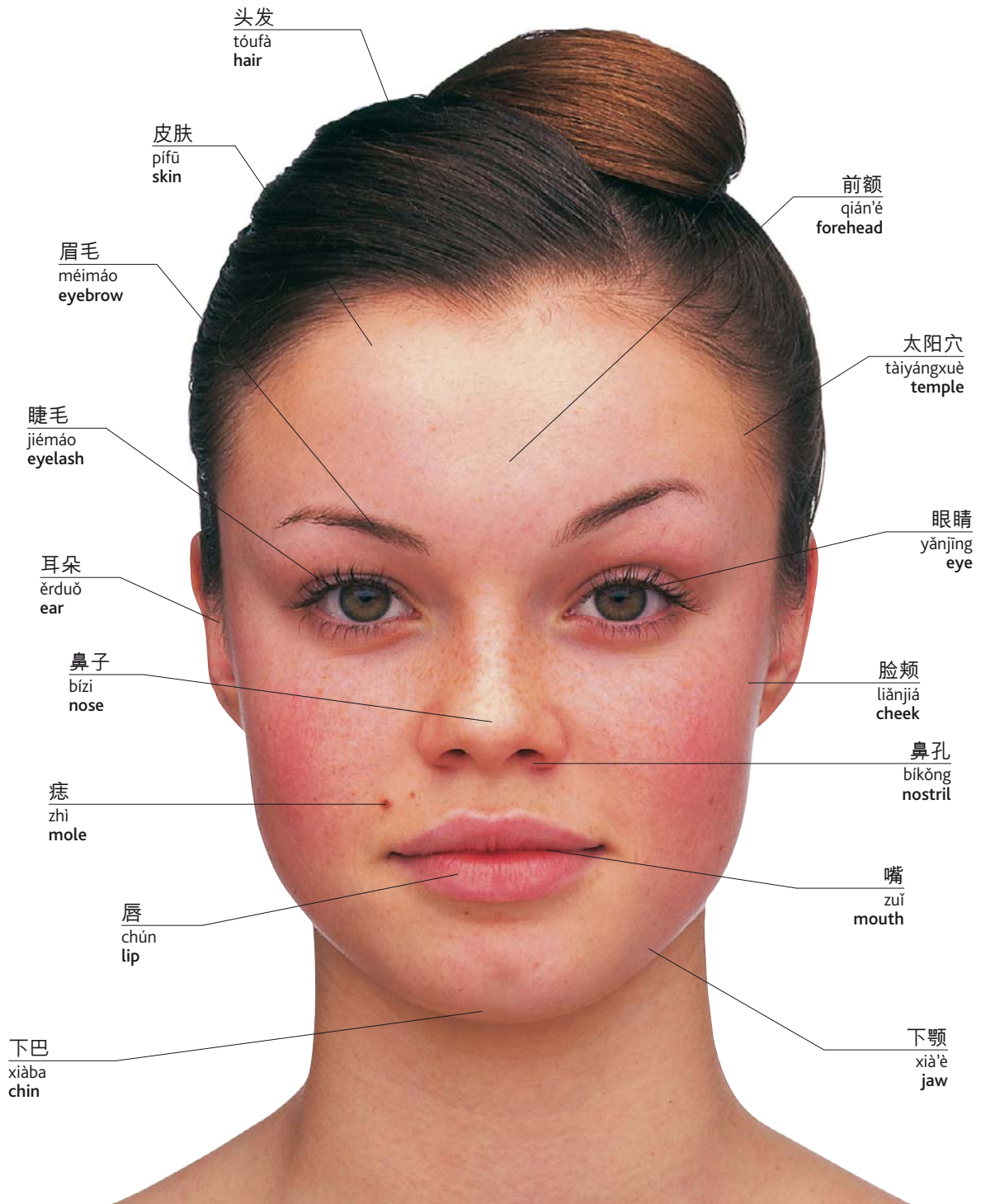



皱纹
zhòuwén
wrinkle



雀斑
quèbān
freckle



毛孔
máokǒng
pore



酒窝
jiǔwō
dimple

手 shǒu • hand

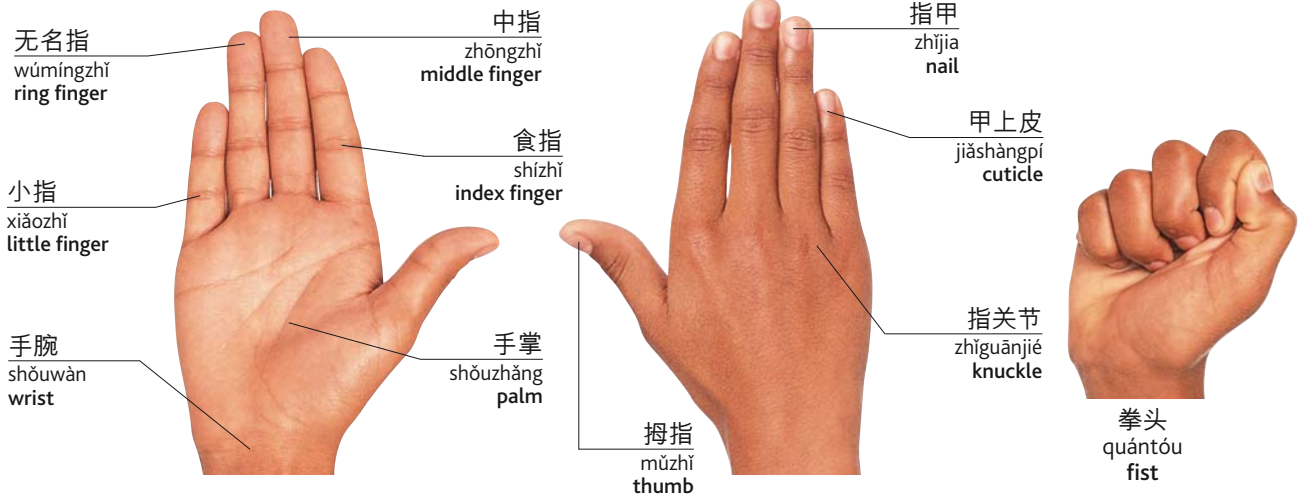

脚 jiǎo • foot

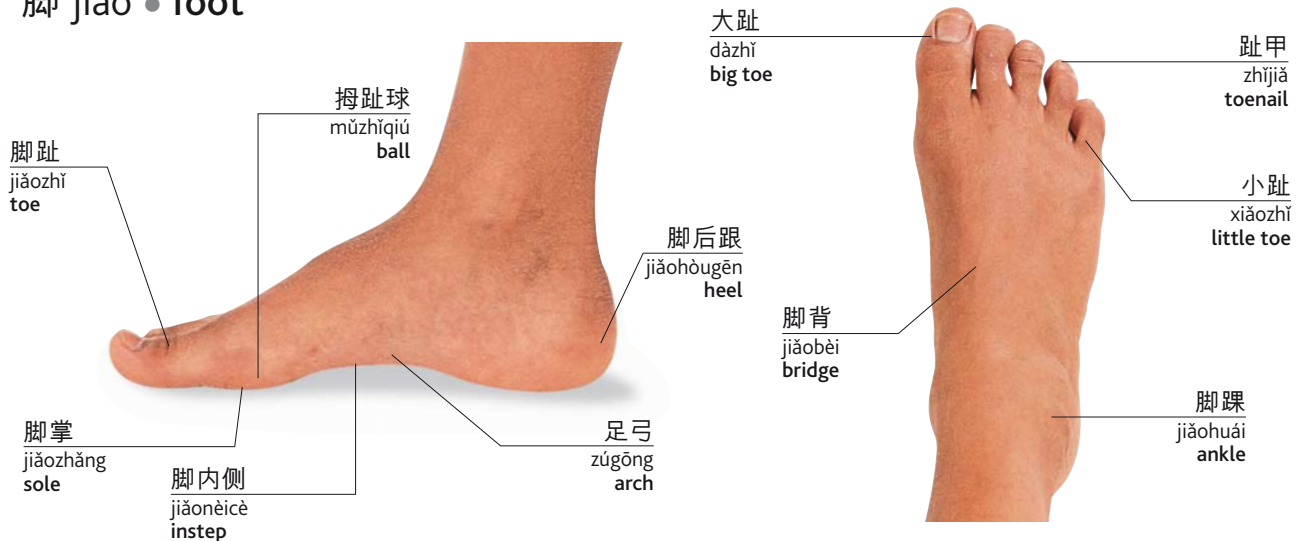

肌肉 jīròu • muscles

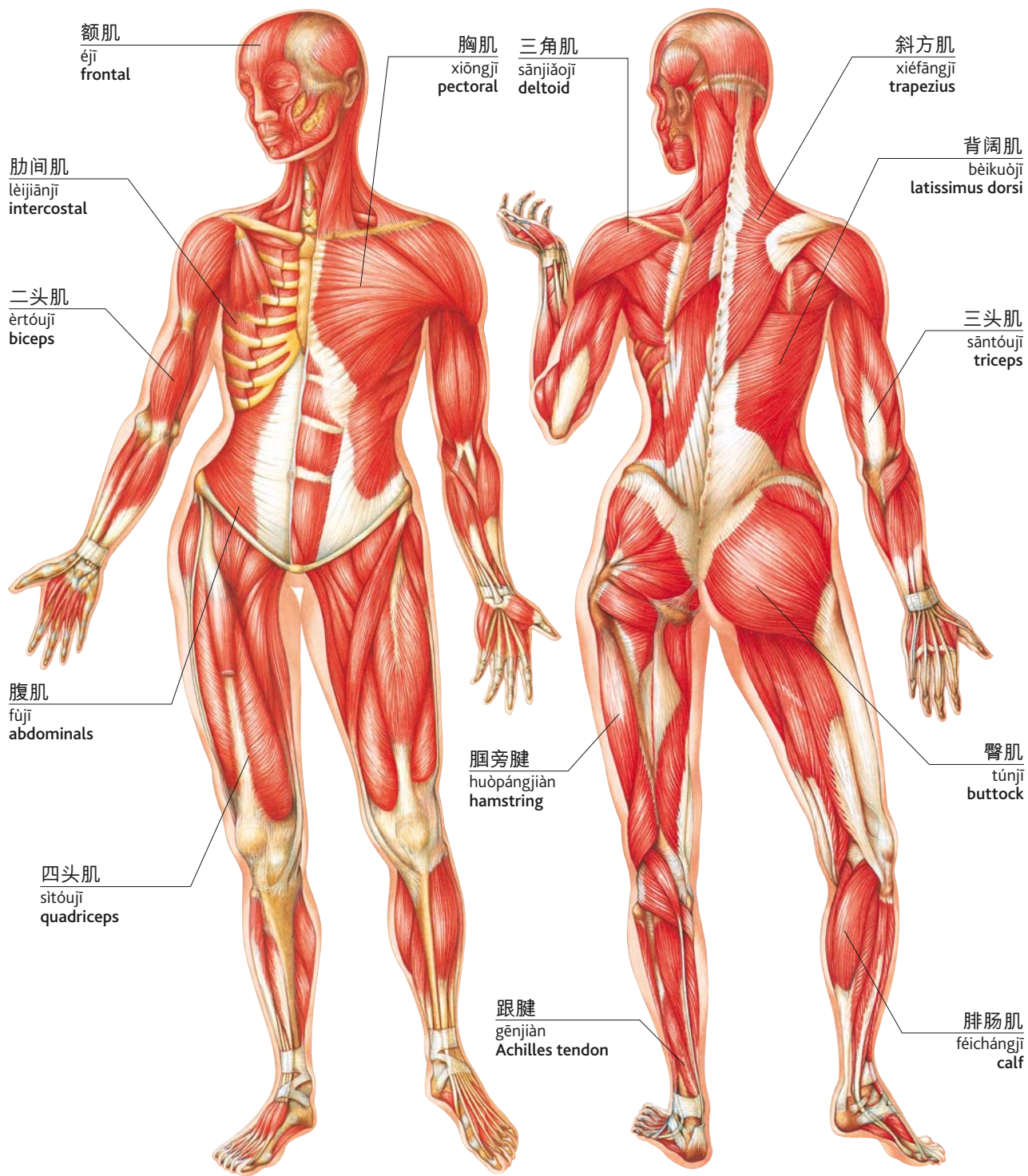

骨骼 gǔgé • skeleton

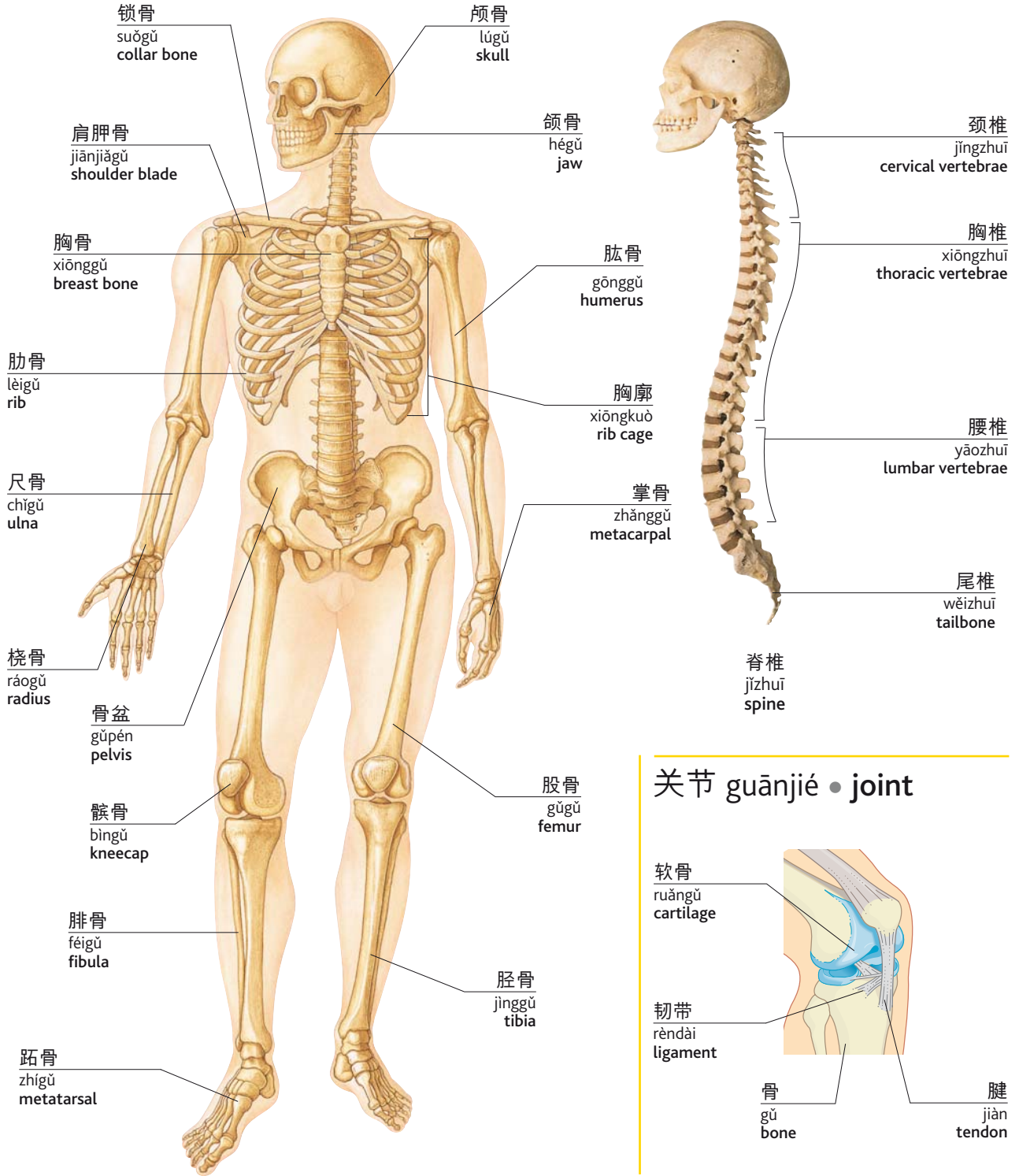

内脏 nèizàng • internal organs

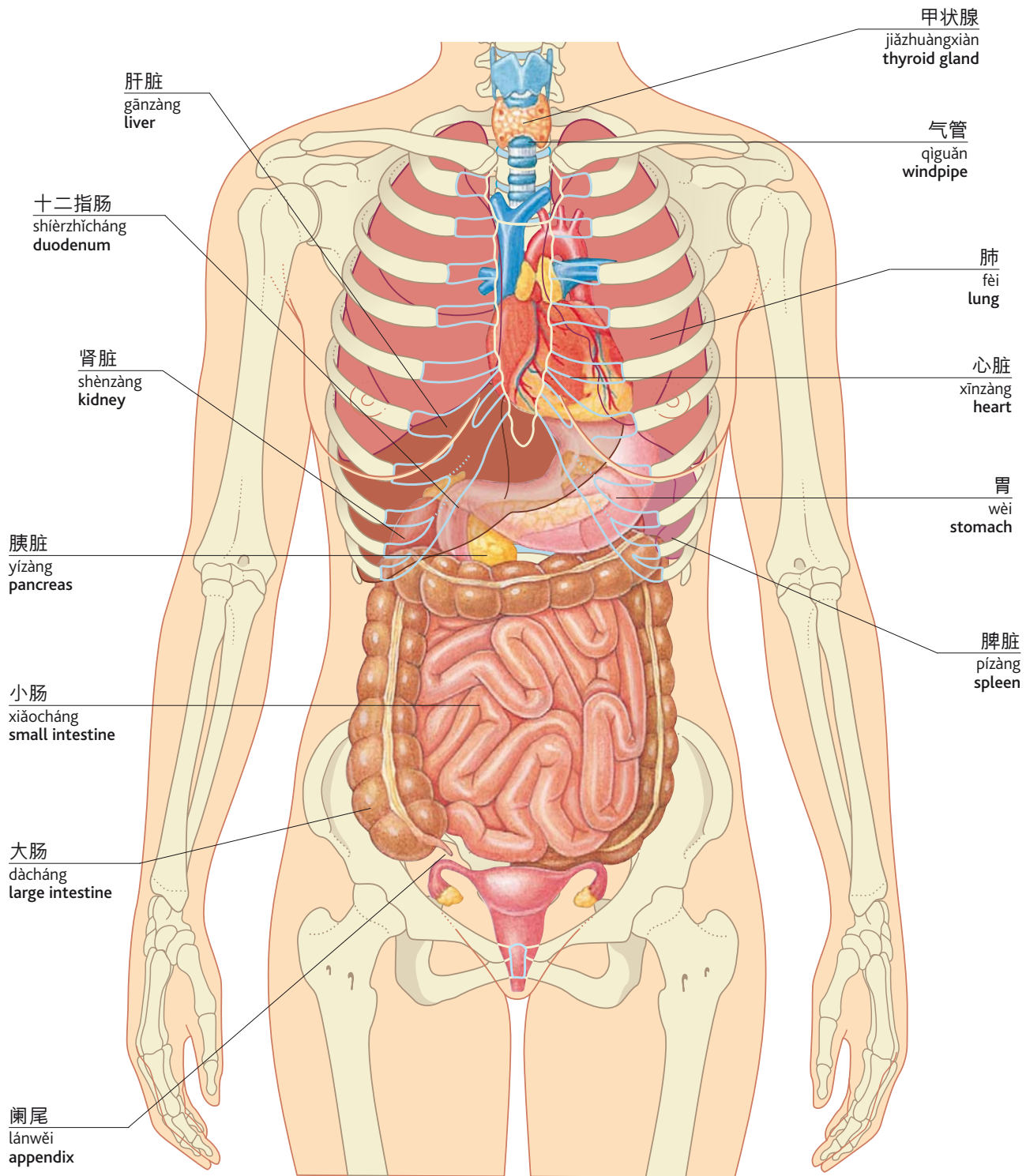

头部 tóubù • head

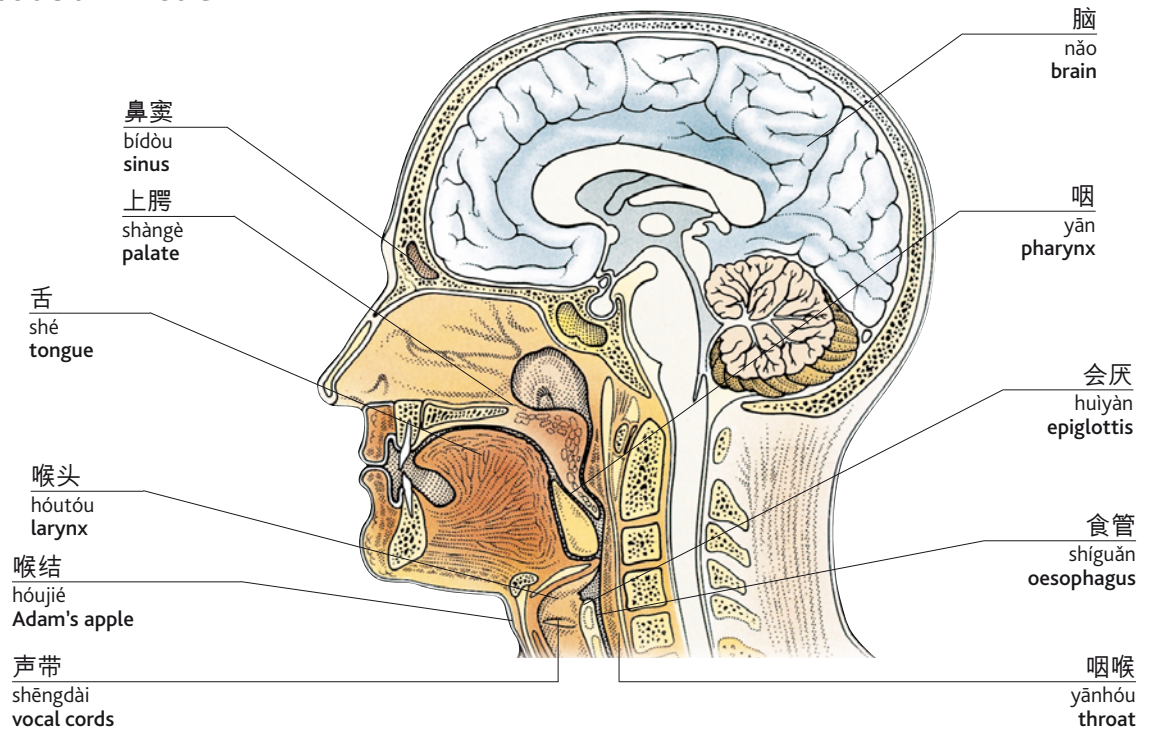

人体系统 réntǐxìtǒng • body systems

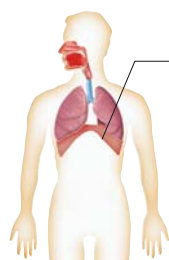

呼吸系统
hūxìxìtǒng
respiratory

横膈膜
hénggémó
diaphragm



消化系统
xiāohuàxìtǒng
digestive

静脉
jìngmài
vein



心血管系统
xīnxuèguǎnxìtǒng
cardiovascular

动脉
dòngmài
artery

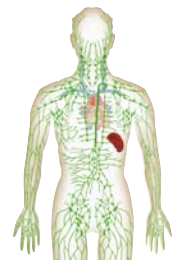

淋巴系统
línbāxìtǒng
lymphatic

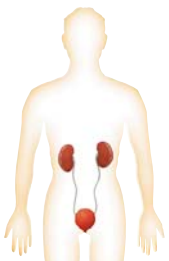

泌尿系统
mìniào-xìtǒng
urinary

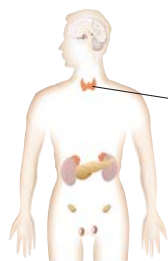

内分泌系统
nèifēnmìxìtǒng
endocrine

腺
xiàn
gland



神经系统
shénjīngxìtǒng
nervous

神经
shénjīng
nerve



生殖系统
shēngzhìxìtǒng
reproductive

生殖器官 shēngzhíqìguān • reproductive organs

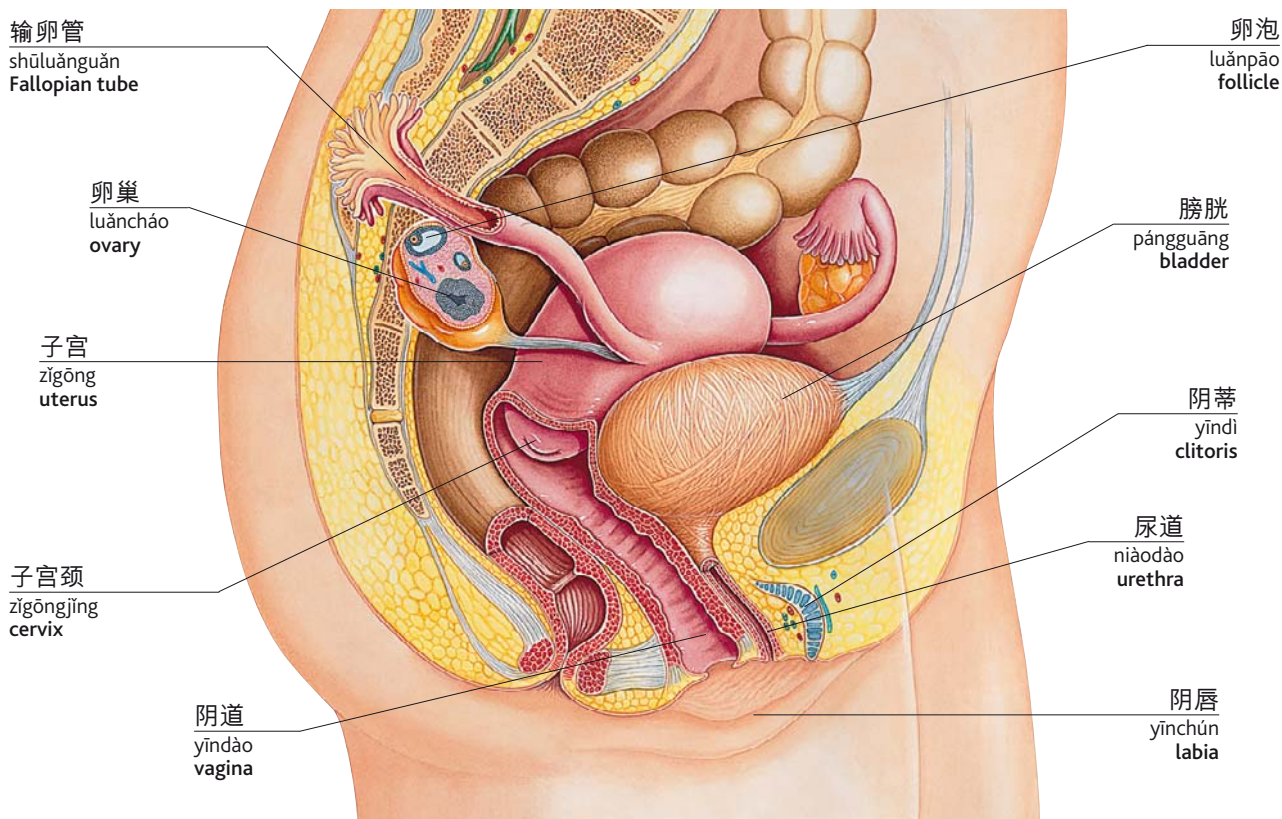

女性 nǚxìng | female

生殖 shēngzhí • reproduction

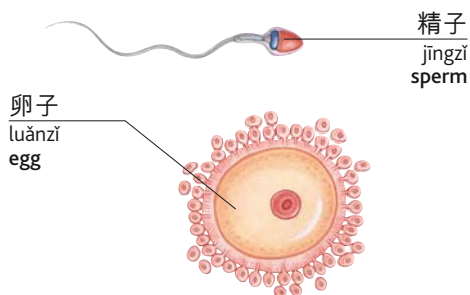

受精 shòujīng | fertilization

词汇 cíhuì • vocabulary

荷尔蒙 hé'ěrméng hormone	阳痿 yángwēi impotent	有生殖能力的 yǒushēngzhínénglìde fertile
排卵 páiluǎn ovulation	怀孕 huáiyùn conceive	月经 yuèjīng menstruation
不育 bùyù infertile	性交 xìngjiāo intercourse	性病 xìngbìng sexually transmitted disease

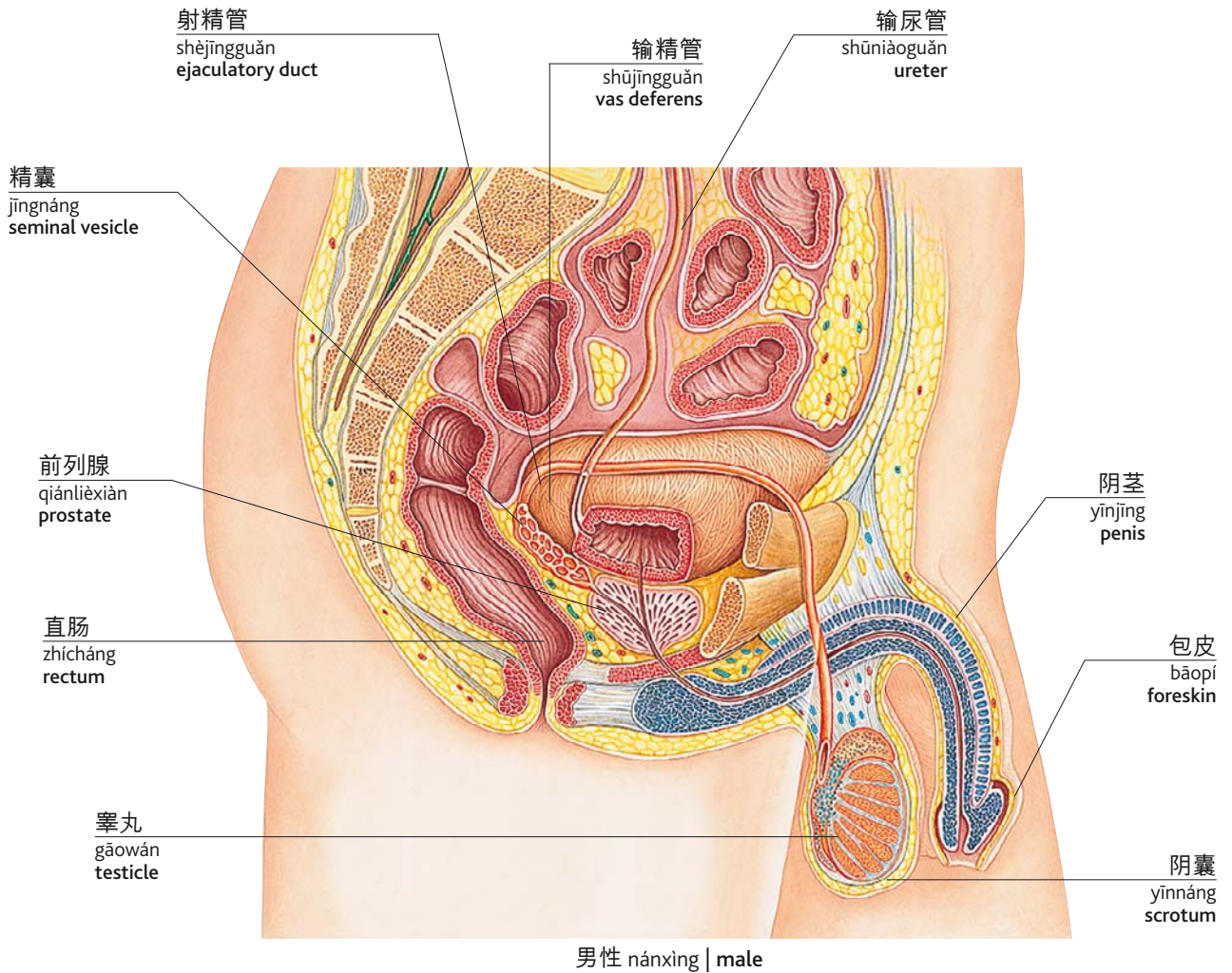

避孕 bìyùn • contraception



家庭 jiāting • family

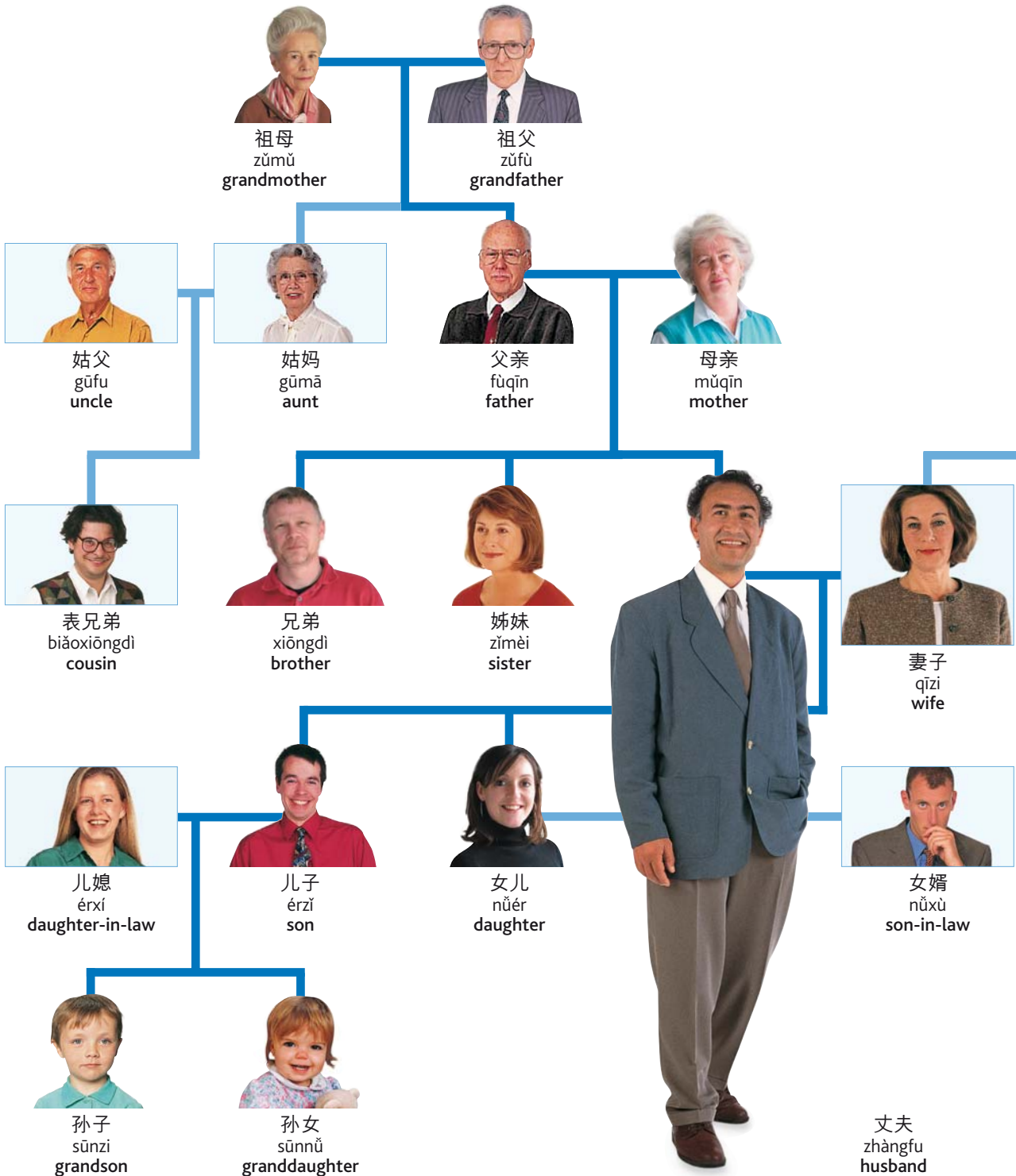

词汇 cíhuì • vocabulary

亲戚
qīnqi
relatives

父母
fùmǔ
parents

孙子女 / 外孙子女
sūnzǐnǚ / wàisūnzǐnǚ
grandchildren

继母
jìmǔ
stepmother

继子
jìzǐ
stepson

配偶
pèiǒu
partner

世代
shìdài
generation

孩子
háizi
children

祖父母 / 外祖父母
zǔfùmǔ / wàizǔfùmǔ
grandparents

继父
jìfù
stepfather

继女
jìnǚ
stepdaughter

双胞胎
shuāngbāotāi
twins



岳母
yuèmǔ
mother-in-law

岳父
yuèfù
father-in-law



妻妹(姐)夫
qīmèi(jiě)fū
brother-in-law



妻妹(姐)
qīmèi(jiě)
sister-in-law



外甥女
wàishēngnǚ
niece



外甥
wàishēng
nephew

太太
tàitài
Mrs

称谓 chēngwèi • titles

小姐
xiǎojiě
Miss

先生
xiānshēng
Mr



成长阶段 chéngzhǎngjiēduàn
• stages



婴儿
yīng'ér
baby



儿童
értóng
child



男孩
nánhái
boy



女孩
nǚhái
girl



青少年
qīngshàonián
teenager



成年人
chéngniánrén
adult



男人
nánrén
man



女人
nǚrén
woman

人际关系 rénjìguānxì • relationships

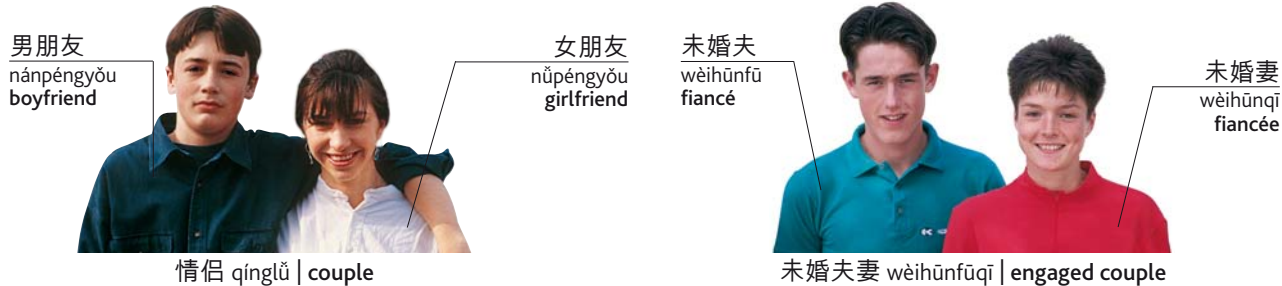

情感 qínggǎn • emotions



微笑
wēixiào
smile

快乐
kuàilè
happy



悲伤
bēishāng
sad



兴奋
xīngfèn
excited



无聊
wúliáo
bored



惊讶
jīngyà
surprised



惊恐
jīngkǒng
scared



愤怒
fènnù
angry

皱眉
zhòuméi
frown



困惑
kùnhuò
confused



忧虑
yōulǜ
worried



紧张
jǐnzhāng
nervous



自豪
zìháo
proud



自信
zìxìn
confident



尴尬
gāngà
embarrassed



羞涩
xiūsè
shy

词汇 cíhuì • vocabulary

烦躁 fánzào upset	笑 xiào laugh (v)	叹息 tànxi sigh (v)	叫喊 jiàohǎn shout (v)
震惊 zhènjīng shocked	哭 kū cry (v)	晕倒 yūndǎo faint (v)	打哈欠 dǎhāqian yawn (v)

人生大事 rénshēngdàshì • life events



出生
chūshēng
be born (v)



入学
rùxué
start school (v)



交友
jiāoyǒu
make friends (v)



毕业
bìyè
graduate (v)



就业
jiùyè
get a job (v)



恋爱
liàn'ài
fall in love (v)



结婚
jiéhūn
get married (v)



生子
shēngzǐ
have a baby (v)



婚礼 hūnlǐ | wedding



离婚
líhūn
divorce



葬礼
zànglǐ
funeral

词汇 cíhuì • vocabulary

洗礼
xǐlǐ
christening

立遗嘱
lìyǐzhǔ
make a will (v)

纪念日
jì'niànrì
anniversary

出生证明
chūshēng zhèngmíng
birth certificate

移民
yímín
emigrate (v)

婚宴
hūnyàn
wedding reception

退休
tuìxiū
retire (v)

蜜月
mìyuè
honeymoon

死亡
sǐwáng
die (v)

犹太男孩成人(13岁)仪式
yóutài nánhái chéngren
(shísānsuì)yíshì
bar mitzvah

节庆 jiéqìng • celebrations

生日聚会
shēngrìjùhuì
birthday party



生日
shēngrì
birthday

贺卡
hèkǎ
card

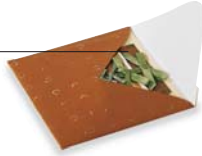

礼物
lǐwù
present



圣诞节
shèngdànjié
Christmas

节日 jiérì
• festivals



逾越节
yúyuèjié
Passover

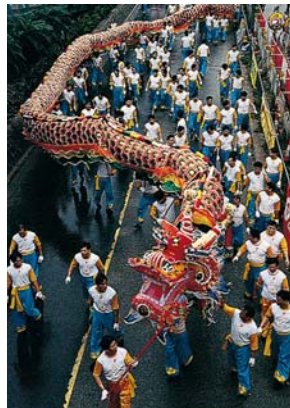

新年
xīnnián
New Year



狂欢节 / 嘉年华会
kuánghuānjié / jiā'niánhuáhuì
carnival

游行
yóuxíng
procession



斋月
zhāiyuè
Ramadan

缎带
duàndài
ribbon



感恩节
gǎn'ēnjié
Thanksgiving



复活节
fùhuójié
Easter



万圣节
wànshèngjié
Halloween



排灯节
páidēngjié
Diwali





外表 wàibiǎo
appearance

童装 tóngzhuāng • children's clothing

婴儿 yīng'ér • baby



背心
bèixīn
vest

摁扣
ènkòu
popper

婴儿连脚裤
yīng'ér liánjiǎokù
babygro



婴儿睡衣
yīng'érshuìyī
sleepsuit



儿童防雪装
értóng fángxuězhuāng
snowsuit



连衫裤
liánshānkù
romper suit



围嘴
wéizǔi
bib



婴儿手套
yīng'érshǒutào
mittens



婴儿鞋
yīng'érxié
booties



绒布尿布
róngbù niàobù
terry nappy



一次性尿布
yícíxìng niàobù
disposable nappy



塑料尿裤
sùliào niàokù
plastic pants

幼儿 yòu'ér • toddler



遮阳帽
zhēyángmào
sunhat



围兜
wéidōu
apron



短裤
duǎnkù
shorts

工装裤
gōngzhuāngkù
dungarees



T恤衫
Txùshān
t-shirt



裙子
qúnzi
skirt

儿童 értóng • child



连衣裙
liányīqún
dress

风帽
fēngmào
hood

凉鞋
liángxié
sandals

夏天
xiàtiān
summer



雨衣
yǔyī
raincoat



牛仔裤
niúzǎikù
jeans

秋天
qiūtiān
autumn



棒形纽扣
bàng xíng
niǔ kòu

粗呢外套
cūnī wàitào
duffel coat

背包
bēibāo
backpack



围巾
wéijīn
scarf

滑雪衫
huáxuěshān
anorak

长筒橡胶靴
chángtǒng
xiàngjiāoxuē
wellington boots

冬天
dōngtiān
winter



室内便袍
shì nèi biànpáo
dressing gown

标识
biāoshí
logo

运动鞋
yùndòngxié
trainers

儿童睡衣
értóng shuìyī
nightie

拖鞋
tuōxié
slippers

睡衣
shuìyī
nightwear



足球球衣
zúqiú qiúyī
football strip



运动服
yùndòngfú
tracksuit



儿童保暖裤
értóng bǎowǎn kù
leggings

词汇 cíhuì • vocabulary

天然纤维
tiānrán xiānwéi
natural fibre

合成的
héchéngde
synthetic

这可以机洗吗？
zhèkěyǐ jīxǐ ma?
Is it machine washable?

这适合两岁的孩子穿吗？
zhè shìhé liǎngsuì de hái zǐ chuān ma?
Will this fit a two-year-old?

男装 nánzhuāng • men's clothing



词汇 cíhuì • vocabulary

衬衫 chènshān
shirt

晨衣 chényī
dressing gown

运动服 yùndòngfú
tracksuit

长 cháng
long

羊毛衫 yángmáoshān
cardigan

内衣裤 nèiyīkù
underwear

雨衣 yǔyī
raincoat

短 duǎn
short

有没有大/小一点儿的尺寸?
yǒuméiyǒu dà/xiǎo yìdiǎn de chǐcùn?
Do you have this in a larger/smaller size?

我可以试穿一下吗?
wǒ kěyǐ shìchuān yíxià ma?
May I try this on?



休闲上衣
xiūxián shàngyī
blazer



粗呢夹克
cūnījīákè
sports jacket



马甲
mǎjiǎ
waistcoat

v型领
Vxínglǐng
v-neck

圆领
yuánlǐng
round neck

T恤衫
Txùshān
t-shirt



运动裤
yùndòngkù
sweatpants



滑雪衫
huáxuěshān
anorak



运动衫
yùndòngshān
sweatshirt



防风夹克
fángfēngjiákè
windcheater



套头毛衣
tàotóumáoyī
sweater



睡衣
shuìyī
pyjamas



背心
bèixīn
vest

便装
biànzhuāng
casual wear



短裤
duǎnkù
shorts



三角内裤
sānjiǎonèikù
briefs



短衬裤
duǎnchèn kù
boxer shorts



袜子
wǎzi
socks

女装 nǚzhuāng • women's clothing



女用内衣 nǚyòng nèiyī • lingerie



女用长睡衣
nǚyòng cháng shuìyī
negligée



衬裙
chènqún
slip

肩带
jiāndài
strap



紧身内衣
jǐnshēn nèiyī
camisole



女式短上衣
nǚshì duǎnshàngyī
basque

吊袜带
diàowǎdài
suspenders



长筒袜
chángtǒngwǎ
stockings



连裤袜
liánkùwǎ
tights

背心
bèixīn
vest



女用内裤
nǚyòng nèikù
knickers



胸罩
xiōngzhào
bra



女睡衣
nǚshuìyī
nightdress

婚礼 hūnlǐ • wedding



头纱
tóushā
veil

花边
huābiān
lace

花束
huāshù
bouquet

拖裾
tuōjū
train

结婚礼服
jiéhūn lǐfú
wedding dress

词汇 cíhuì • vocabulary

束腹
shùfù
corset

剪裁考究
jiǎncái kǎojiū
tailored

松紧袜带
sōngjǐn wǎdài
garter

露背装
lòubèizhuāng
halter neck

垫肩
diànjiān
shoulder pad

内有金属丝的(胸罩)
nèiyǒu jīnshǔsīde (xiōngzhào)
underwired

腰带
yāodài
waistband

运动胸罩
yùndòng xiōngzhào
sports bra

配饰 pèishì • accessories



帽子
màozi
cap



礼帽
lǐmào
hat



围巾
wéijīn
scarf



腰带扣
yāodàikòu
buckle

腰带
yāodài
belt

柄
bǐng
handle



尖
jiān
tip

伞
sǎn
umbrella



手帕
shǒupà
handkerchief



领结
lǐngjié
bow tie



领带夹
lǐngdàijiā
tie-pin



手套
shǒutào
gloves

首饰 shǒushi • jewellery



项链坠
xiàngliǎnzhuì
pendant



胸针
xiōngzhēn
brooch



袖扣
xiùkòu
cufflink

珍珠项链
zhēnzhū xiàngliàn
string of pearls

链环
liànhuán
link



手镯
shǒuzhuó
bracelet

链扣
liànkòu
clasp



链子
liànzi
chain

耳环
ěrhuán
earring

戒指
jièzhǐ
ring

宝石
bǎoshí
stone

项链
xiàngliàn
necklace

手表
shǒubiǎo
watch



首饰盒 shǒushìhé | jewellery box

包 bāo • bags



钱夹
qiánjiǎ
wallet



钱包
qiánbāo
purse



挎包
kuàbāo
shoulder bag

扣环
kòuhuán
fastening

背带
bēidài
shoulder strap

提手
tíshǒu
handles



旅行袋
lǚxíngdài
holdall



公文包
gōngwénbāo
briefcase



手提包
shòutibāo
handbag



背包
bēibāo
backpack

鞋 xié • shoes

鞋眼
xiéyǎn
eyelet

鞋带
xié dài
lace

鞋舌
xiéshé
tongue

鞋底
xiédǐ
sole

鞋跟
xiégēn
heel



系带鞋
xidàixié
lace-up



步行靴
bùxíngxuē
walking boot



运动鞋
yùndòngxié
trainer



皮鞋
píxié
leather shoe



平底人字拖鞋
píngdǐ rénzì tuōxié
flip-flop



高跟鞋
gāogēnxié
high heel shoe



厚底鞋
hòudǐxié
platform shoe



凉鞋
liángxié
sandal



无带便鞋
wúdài biànxué
slip-on



镂花皮鞋
lòuhuā píxié
brogue

头发 tóufà • hair



发梳
fāshū
comb

梳头
shūtóu
comb (v)



发刷
fāshuā
brush

刷头发 shuātóufà | brush (v)



冲洗
chōngxǐ
rinse (v)



美发师
měifāshī
hairdresser

洗头盆
xītóupén
sink

顾客
gùkè
client

洗 xǐ | wash (v)



罩衫
zhàoshān
robe

剪
jiǎn
cut (v)



吹干
chuīgān
blow dry (v)



定型
dìngxíng
set (v)

美发用品 měifà yòngpǐn • accessories



吹风机
chuīfēngjī
hairdryer



洗发水
xǐfāshuǐ
shampoo



护发素
hùfàsù
conditioner



发胶
fàjiāo
gel



定型水
dìngxíngshuǐ
hairspray



剪刀
jiǎndāo
scissors



发箍
fàgū
hairband



卷发夹子
juǎnfā jiāzi
curler



发卡
fàqiǎ
hairpin

发型 fàxíng • styles



马尾辫
mǎwěibiàn
ponytail

丝带
sīdài
ribbon



麻花辫
máhuābiàn
plait



法式盘头
fǎshì pántóu
french pleat



发髻
fàjì
bun



小辫
xiǎobiàn
pigtails



女式短发
nǚshì duǎnfǎ
bob



短发
duǎnfǎ
crop



卷发
juǎnfǎ
curly



烫发
tàngfǎ
perm



直发
zhífǎ
straight



挑染
tiāorǎn
highlights

发根
fāgēn
roots



秃顶
tūdǐng
bald



假发
jiǎfǎ
wig

发色 fàsè • colours



金色
jīnsè
blonde



深褐色
shēnhèsè
brunette



红褐色
hónghèsè
auburn



红棕色
hóngzōngsè
ginger



黑色
hēisè
black



灰色
huīsè
grey



白色
báisè
white



染色的
rǎnsède
dyed

词汇 cíhuì • vocabulary

修剪
xiūjiǎn
trim (v)

拉直
lāzhí
straighten (v)

理发师
lǐfàshī
barber

头皮屑
tóupíxiè
dandruff

发梢分叉
fàshāo fēnchā
split ends

油性(发质)
yóuxìng (fàzhì)
greasy

干性(发质)
gānxìng (fàzhì)
dry

中性(发质)
zhōngxìng (fàzhì)
normal

头皮
tóupí
scalp

发带
fàdài
hairtie

美容 měiróng • beauty



化妆 huàzhuāng • make-up



眉笔 méibǐ
eyebrow pencil



眉刷 méishuā
eyebrow brush



眉夹 méijiā
tweezers



唇彩 chúncai
lip gloss



唇刷 chúnshuā
lip brush



唇线笔 chúnxiànbǐ
lip liner



化妆刷 huàzhuāngshuā
brush



遮瑕膏 zhēxiágāo
concealer

化妆镜 huàzhuāngjìng
mirror

粉饼 fēnbǐng
face powder

粉扑 fēnpū
powder puff



粉盒 fēnhé | compact

美容护理 měirónghùlǐ • beauty treatments



面膜
miànmó
face pack

紫外线浴床
zǐwàixiàn yùchuáng
sunbed

去死皮
qù sǐpí
exfoliate (v)

面部护理
miàn bùhùlǐ
facial

热蜡脱毛
rèlàtuōmáo
wax

趾甲护理
zhǐjiǎ hùlǐ
pedicure

指甲护理 zhǐjiǎ hùlǐ • manicure



洗甲水
xǐjiǎshuǐ
nail varnish remover

指甲油
zhǐjiǎyóu
nail varnish

指甲锉
zhǐjiǎcuò
nail file

指甲剪
zhǐjiǎjiǎn
nail scissors

指甲刀
zhǐjiǎdāo
nail clippers

化妆用品 huàzhuāng yòngpǐn • toiletries



洁面水
jiémiànshuǐ
cleanser

爽肤水
shuǎngfūshuǐ
toner

保湿霜
bǎoshīshuāng
moisturizer

黑肤霜
hēifūshuāng
self-tanning cream

香水
xiāngshuǐ
perfume

淡香水
dànxiāngshuǐ
eau de toilette

词汇 cíhuì • vocabulary

肤色
fūsè
complexion

油性(皮肤)
yóuxìng(pífū)
oily

棕褐色皮肤
zōnghèsè pífū
tan

皮肤白皙
pífū báixī
fair

敏感性的
mǐngǎnxìngde
sensitive

纹身
wénshēn
tattoo

肤色较深
fūsè jiàoshēn
dark

低变应原的
dībiànyīngyuánde
hypoallergenic

抗皱
kàngzhòu
anti-wrinkle

干性(皮肤)
gànxìng(pífū)
dry

色调
sèdiào
shade

棉球
miánqiú
cotton balls





健康 jiànkāng
health



疾病 jíbìng • illness



发烧 fāshāo | fever



头痛
tóutòng
headache



鼻血
bíxiě
nosebleed



咳嗽
késou
cough



喷嚏
pēntǐ
sneeze



感冒
gǎnmào
cold



流感
liúgǎn
flu



气雾剂
qìwùjì
inhaler

哮喘
xiàochuǎn
asthma



痉挛
jìngluán
cramps



恶心
ěxīn
nausea



水痘
shuǐdòu
chickenpox



皮疹
pízhěn
rash

词汇 cíhuì • vocabulary

中风
zhòngfēng
stroke

糖尿病
tángniàobìng
diabetes

湿疹
shīzhěn
eczema

寒战
hánzhàn
chill

呕吐
ǒutù
vomit (v)

腹泻
fùxiè
diarrhoea

血压
xuèyā
blood pressure

过敏
guòmǐn
allergy

传染
chuánrǎn
infection

胃痛
wèitòng
stomach ache

癫痫
diānxián
epilepsy

麻疹
mázhěn
measles

心肌梗塞
xīnjī gēngsè
heart attack

枯草热
kūcǎorè
hayfever

病毒
bìngdú
virus

昏厥
hūnjué
faint (v)

偏头痛
piāntóutòng
migraine

腮腺炎
sāixiànyán
mumps

医生 yīshēng • doctor
 诊断 zhěnduàn • consultation

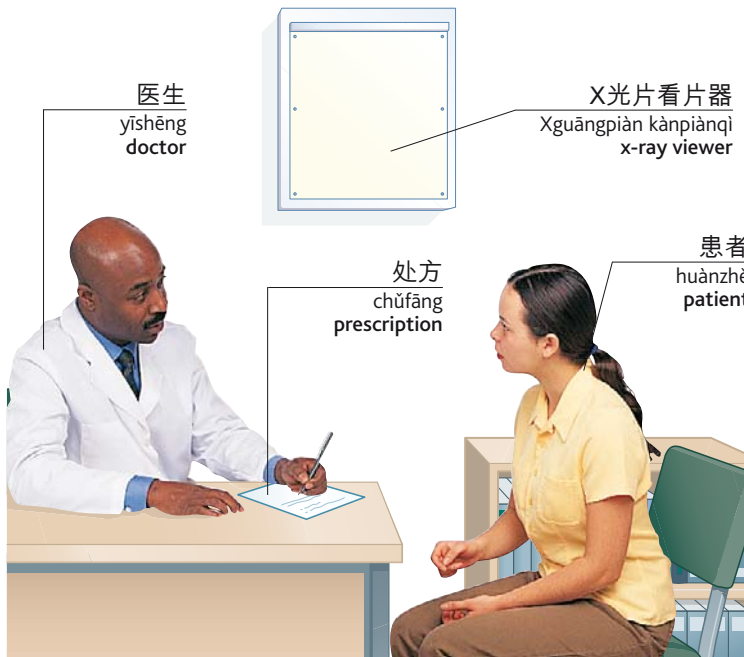

医生
yīshēng
doctor

X光片看片器
Xguāngpiàn kànpianqì
x-ray viewer

处方
chǔfāng
prescription

患者
huànzhě
patient

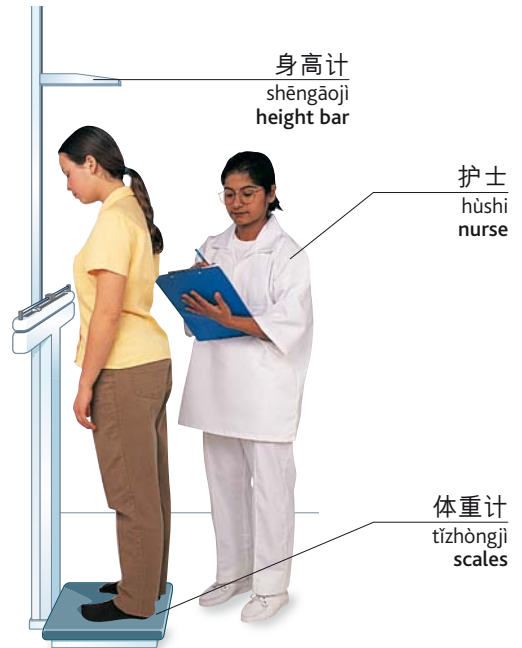

身高计
shēngāoji
height bar

护士
hùshi
nurse

体重计
tǐzhòngjì
scales

血压计
xuèyājì
blood pressure gauge

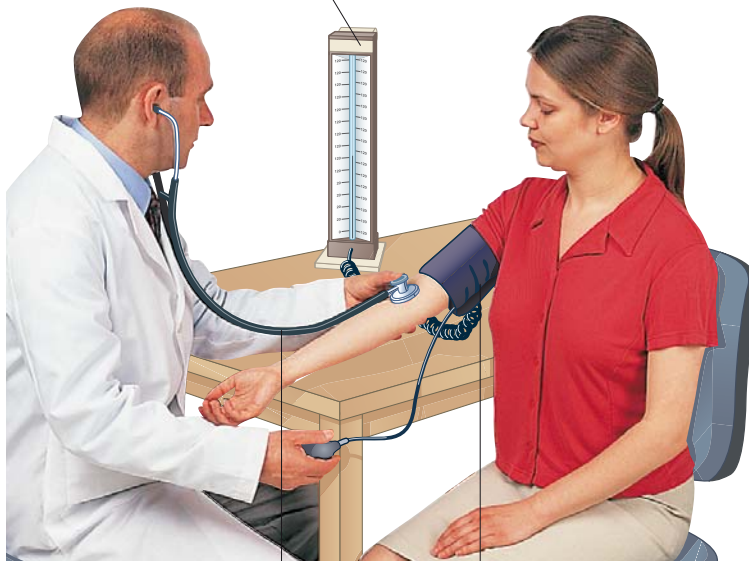

听诊器
tīngzhěncì
stethoscope

充气袖带
chōngqì xiùdài
cuff

词汇 cíhuì • vocabulary

预约
yùyuē
appointment

接种
jiēzhòng
inoculation

诊疗室
zhěnliaoshì
surgery

体温计
tǐwēnjì
thermometer

候诊室
hòuzhěncì
waiting room

体检
tǐjiǎn
medical examination

我需要看医生。
wǒ xūyào kànyīshēng.
I need to see a doctor.

这儿疼。
zhè'ér téng.
It hurts here.

创伤 chuāngshāng • injury



扭伤 niǔshāng | sprain

医用吊带
yīyòng
diàodài
sling



颈托
jǐngtuō
neck brace

骨折
gǔzhé
fracture



头颈部损伤
tóujǐngbù sǔnshāng
whiplash



割伤
gēshāng
cut



擦伤
cāshāng
graze



淤伤
yūshāng
bruise



刺伤
cìshāng
splinter



晒伤
shàishāng
sunburn



烧伤
shāoshāng
burn



咬伤
yǎoshāng
bite



蜇伤
zhēshāng
sting

词汇 cíhuì • vocabulary

事故
shìgù
accident

大出血
dàchūxuè
haemorrhage

中毒
zhòngdú
poisoning

他/她没事吧？
tā/tā méishi ba?
Will he/she be all right?

紧急情况
jǐnjí qíngkuàng
emergency

水泡
shuǐpào
blister

电击
diànjī
electric shock

哪里疼？
nǎlǐ téng?
Where does it hurt?

伤口
shāngkǒu
wound

脑震荡
nǎozhèndàng
concussion

头部损伤
tóubù sǔnshāng
head injury

请叫救护车。
qǐngjiào jiùhùchē。
Please call an ambulance.

急救 jíjiù • first aid

药膏
yàogāo
ointment

创可贴
chuàngkětīe
plaster

安全别针
ānquán biézhēn
safety pin

绷带
bēngdài
bandage

止痛药
zhītòngyào
painkillers



消毒湿巾
xiāodú shījīn
antiseptic wipe

镊子
nièzi
tweezers

剪刀
jiǎndāo
scissors

消毒剂
xiāodújī
antiseptic

急救箱 jíjiùxiāng | first aid box

纱布
shābù
gauze



包扎
bāozā
dressing



医用夹板 yīyòngjiābǎn | splint



橡皮膏
xiàngpí gāo
adhesive tape



复苏术
fùsūshù
resuscitation

词汇 cíhuì • vocabulary

休克
xiūkè
shock

脉搏
màibó
pulse

窒息
zhìxī
choke (v)

您能帮帮我吗?
nín néng bāngbāng wǒ ma?
Can you help?

不省人事
bùxǐng rénshì
unconscious

呼吸
hūxī
breathing

无菌
wújūn
sterile

你会急救吗?
nǐ huì jíjiù ma?
Do you know first aid?

医院 yīyuàn • hospital



验血 yànxuè
blood test



注射 zhùshè
injection

移动病床 yídòng bìngchuáng
trolley



急诊室 jízhěnshì
emergency room

呼叫按钮 hūjiào ànniǔ
call button



病房 bìngfáng
ward



轮椅 lúnǚ
wheelchair



X光 Xguāng
x-ray

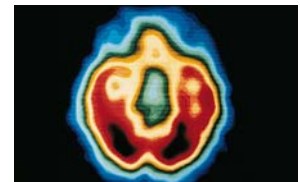

CT扫描 CT sǎomiào
scan

词汇 cíhuì • vocabulary

手术 shǒushù
operation

出院 chūyuàn
discharged

探视时间 tànshì shíjiān
visiting hours

儿童病房 értóng bìngfáng
children's ward

加护病房 jiāhù bìngfáng
intensive care unit

收治的 shōuzhìde
admitted

诊所 zhěnsuǒ
clinic

产科病房 chǎnkē bìngfáng
maternity ward

单人病房 dānrén bìngfáng
private room

门诊病人 ménzhěn bìnggrén
outpatient

科室 kēshì • departments



耳鼻喉科
ěrbíhóukē
ENT



心脏病科
xīnzàngbīngkē
cardiology



整形外科
zhěngxíngwàikē
orthopaedy



妇科
fùkē
gynaecology



理疗科
lǐliáokē
physiotherapy



皮肤科
pífukē
dermatology



儿科
érkē
paediatrics



放射科
fàngshèkē
radiology



外科
wàikē
surgery



产科
chǎnkē
maternity



精神科
jīngshénkē
psychiatry



眼科
yǎnkē
ophthalmology

词汇 cíhuì • vocabulary

神经科
shénjīngkē
neurology

泌尿科
mìniàokē
urology

内分泌科
nèifēnmìkē
endocrinology

病理科
bīnglǐkē
pathology

结果
jiéguǒ
result

肿瘤科
zhǒngliúkē
oncology

矫形外科
jiǎoxíngwàikē
plastic surgery

转诊
zhuǎnzhěn
referral

检查
jiǎnchá
test

专科医生
zhuānkē yīshēng
consultant

牙医 yáyī • dentist

牙齿 yáchǐ • tooth

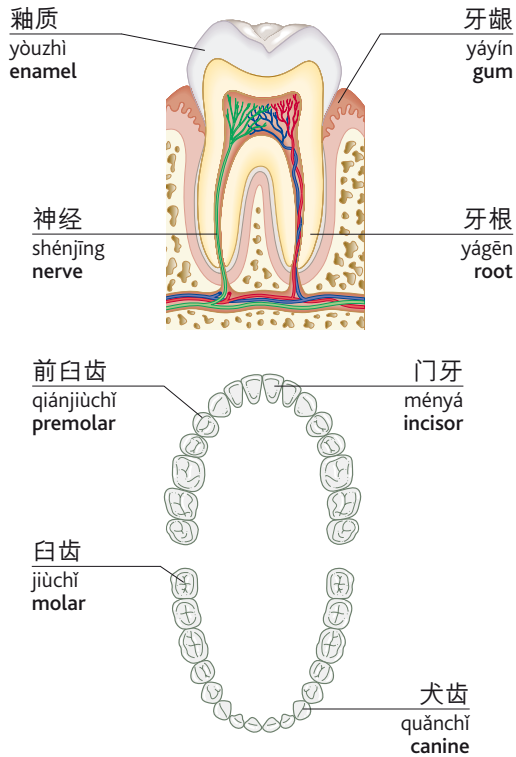

检查 jiǎnchá • check-up

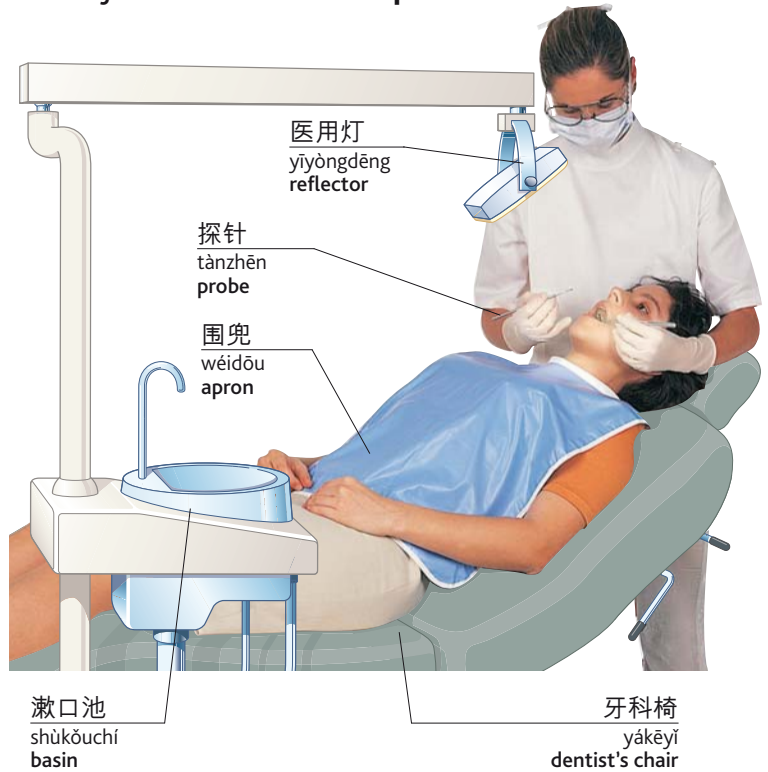

词汇 cíhuì • vocabulary

牙痛 yátòng toothache

牙钻 yázuàn drill

牙菌斑 yájūnbān plaque

牙线 yáxiàn dental floss

龋齿 qǔchǐ decay

拔牙 báiyá extraction

填充物 tiánchōngwù filling

齿冠 chǐguān crown



用牙线洁齿 yòng yáxiàn jiéchǐ floss (v)



刷牙 shuāyá brush



畸齿矫正器 jǐchǐ jiàozhèngqì brace



口腔光 kǒuqiāngguāng dental x-ray

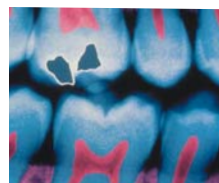

牙片 yápiàn x-ray film



假牙 jiǎyá dentures

配镜师 pèijìngshī • optician



视力检查 shìlì jiǎnchá | eye test

眼镜盒
yǎnjìng hé
case



眼镜
yǎnjìng
glasses

镜片
jìngpiàn
lens



太阳镜
tàiyángjìng
sunglasses

镜架
jìngjià
frame

清洁液
qīngjiéyè
cleaning fluid



消毒液
xiāodúyè
disinfectant solution



隐形眼镜盒
yǐnxíng yǎnjìng hé
lens case

隐形眼镜 yǐnxíng yǎnjìng | contact lenses

眼睛 yǎnjīng • eye

眉毛
méimáo
eyebrow

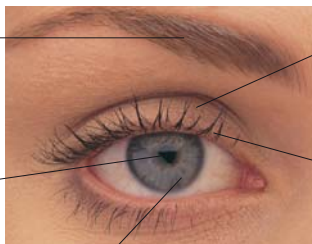

眼睑
yǎnjiǎn
eyelid

瞳孔
tóngkǒng
pupil

眉毛
méimáo
eyelash

虹膜
hóngmó
iris

视网膜
shìwǎngmó
retina

晶状体
jīngzhuàngtǐ
lens

角膜
jiǎomó
cornea

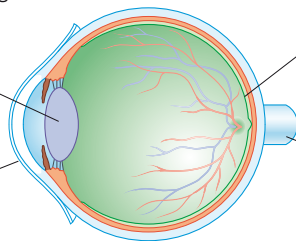

视神经
shìshénjīng
optic nerve

词汇 cíhuì • vocabulary

视力
shìlì
vision

散光
sǎnguāng
astigmatism

屈光度
qūguāngdù
diopter

远视
yuǎnshì
long sight

眼泪
yǎnlèi
tear

近视
jìnshì
short sight

白内障
báinèizhàng
cataract

双光的
shuāngguāngde
bifocal

怀孕 huáiyùn • pregnancy

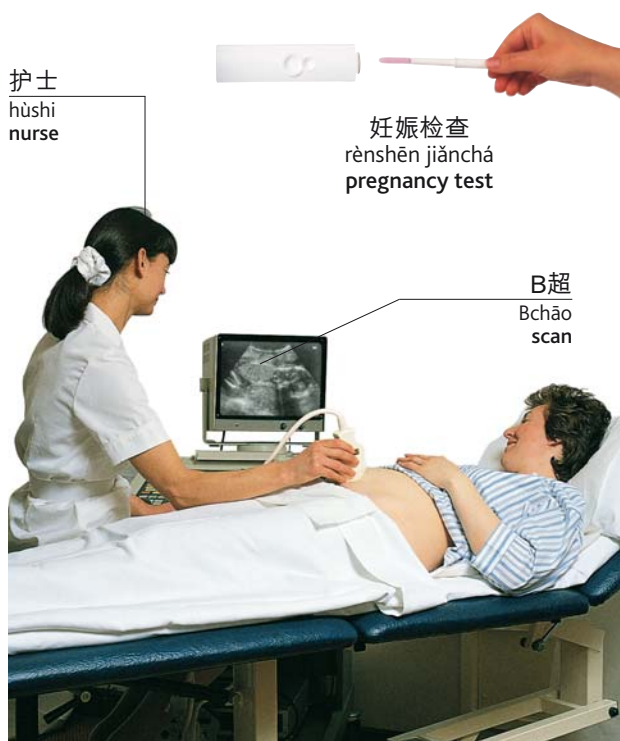

超声波(检查) chāoshēngbō(jiǎnchá) | ultrasound

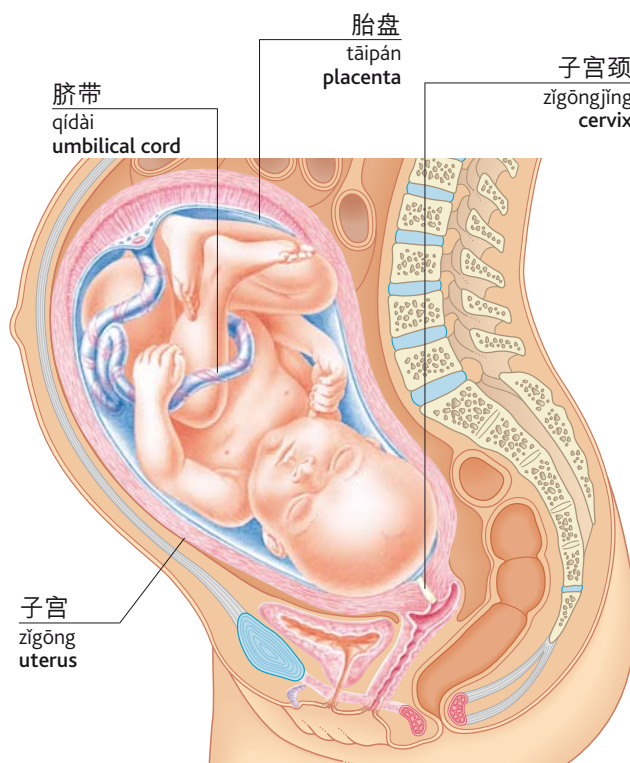

胎儿 tāi'ér | foetus

词汇 cíhuì • vocabulary

排卵 páiluǎn ovulation

出生前 chūshēngqián antenatal

宫缩 gōngsuō contraction

扩张术 kuòzhāngshù dilation

分娩 fēnmiǎn delivery

逆产 nìchǎn breech

怀孕 huáiyùn conception

胚胎 pēitāi embryo

破羊水 pòyángshuǐ break waters (v)

硬膜外麻醉 yìngmó wài mázui epidural

出生 chūshēng birth

早产的 zǎochǎnde premature

怀孕的 huáiyùnde pregnant

子宫 zǐgōng womb

羊水 yángshuǐ amniotic fluid

外阴切开术 wàiyīn qiēkāishù episiotomy

流产 liúchǎn miscarriage

妇科医生 fùkē yīshēng gynaecologist

待产的 dàichǎnde expectant

怀孕三个月 huáiyùnsāngèyuè trimester

羊水穿刺诊断 yángshuǐ chuāncǐ zhěnduàn amniocentesis

剖腹产 pōufùchǎn caesarean section

缝合 fénghé stitches

产科医生 chǎnkē yīshēng obstetrician

分娩 fēnmiǎn • childbirth

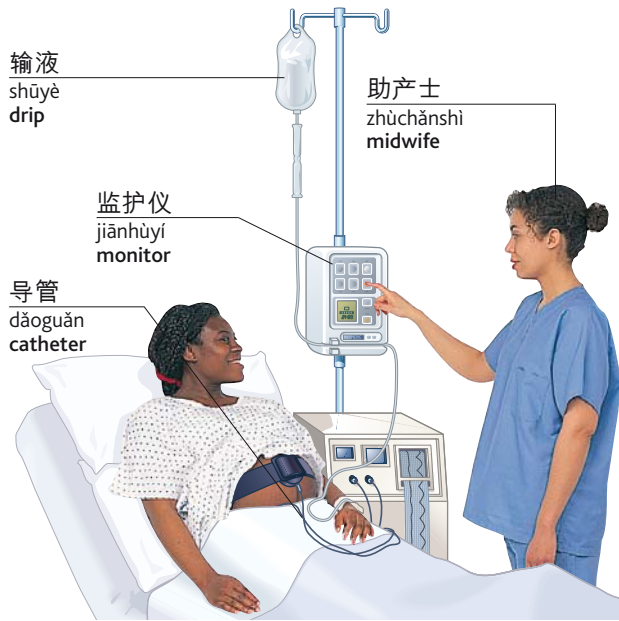

引产 yǐnchǎn | induce labour (v)



育婴箱 yùyīngxiāng | incubator



婴儿秤 yīng'ěrchèng scales

出生时体重 chūshēngshí tǐzhòng | birth weight

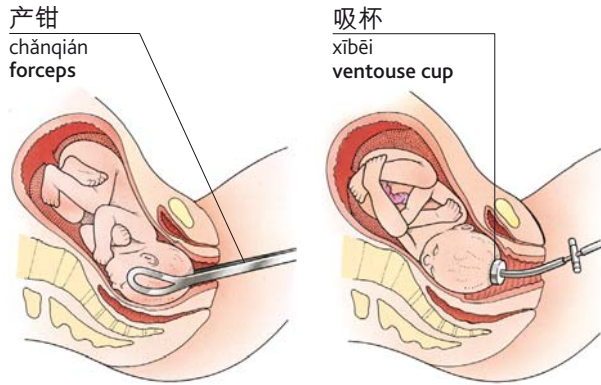

产钳 chǎnqián
forceps

吸杯 xībēi
ventouse cup

助产 zhùchǎn
assisted delivery

身份标签 shēnfēnbiāoqiān
identity tag



新生儿 xīnshēng'ér | newborn baby

哺乳 bǔrǔ • nursing



吸乳器 xīrǔqì
breast pump



喂母乳 bǔrǔ xiǒngzhào
nursing bra



喂母乳 wèi mǔrǔ
breastfeed (v)



乳垫 rǔdiàn
pads

替代疗法 tìdài liáofǎ • alternative therapy

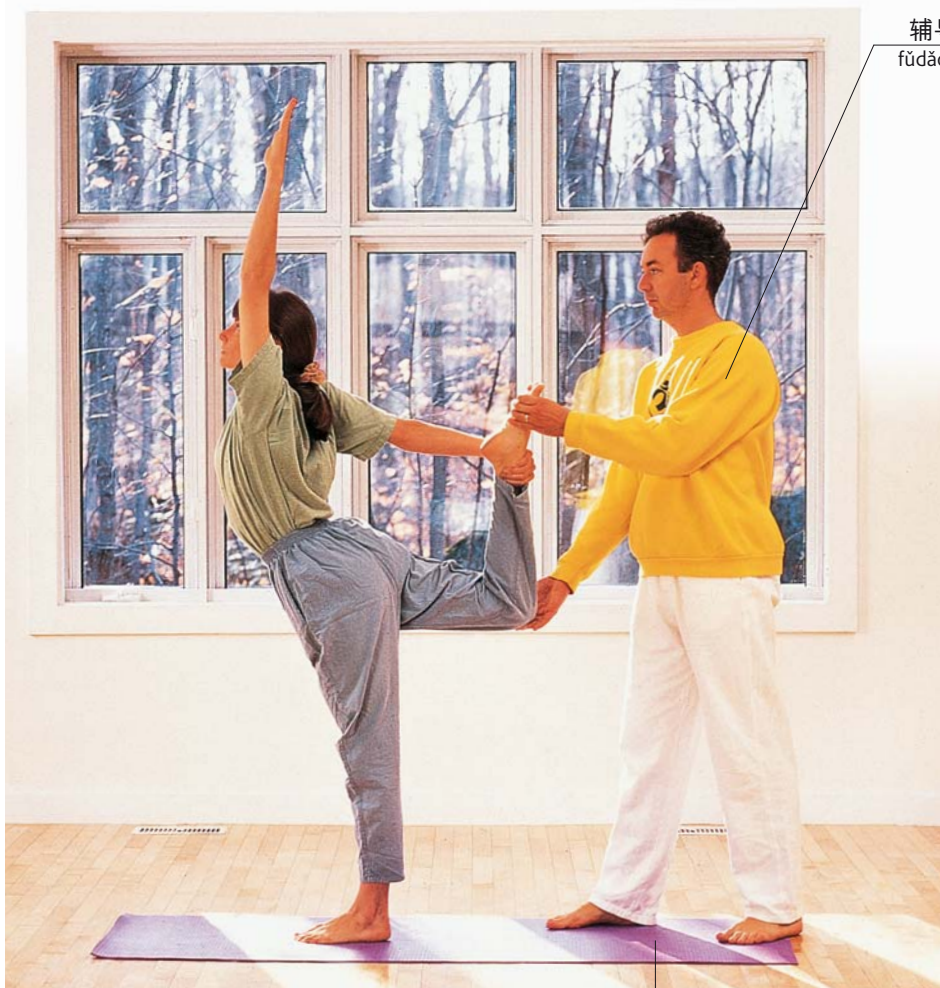

瑜伽 yújiā | yoga

辅导教师
fúdǎo jiàoshī
teacher



按摩
àn mó
massage



指压按摩
zhǐyā àn mó
shiatsu



冥想
míngxiǎng
meditation

垫子
diànzi
mat



脊柱按摩法
jǐzhù àn mó fǎ
chiropractic

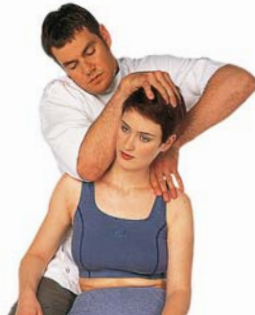

整骨疗法
zhěnggǔ liáofǎ
osteopathy



足底反射疗法
zú dǐ fǎn shè liáofǎ
reflexology

顾问
gūwèn
counsellor



集体治疗
jítǐ zhìliáo
group therapy

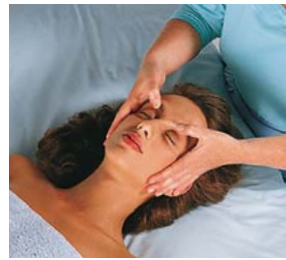

灵气疗法
língqì liáofǎ
reiki



针灸
zhēnjiǔ
acupuncture



印度草药疗法
yīndù cǎoyào liáofǎ
ayurveda



催眠疗法
cuīmián liáofǎ
hypnotherapy



本草疗法
běncǎo liáofǎ
herbalism

精油
jīngyóu
essential oils



芳香疗法
fāngxiāng liáofǎ
aromatherapy



顺势疗法
shùnsì liáofǎ
homeopathy



指压疗法
zhǐyā liáofǎ
acupressure

治疗师
zhìliáoshī
therapist



精神疗法
jīngshén liáofǎ
psychotherapy

词汇 cíhuì • vocabulary

营养品
yíngyǎngpǐn
supplement

自然疗法
zìrán liáofǎ
naturopathy

放松
fàngsōng
relaxation

药草
yàocǎo
herb

水疗
shuǐliáo
hydrotherapy

风水
fēngshuǐ
feng shui

压力
yālì
stress

水晶疗法
shuǐjīng liáofǎ
crystal healing





家居 jiājū
home

房屋 fángwū • house

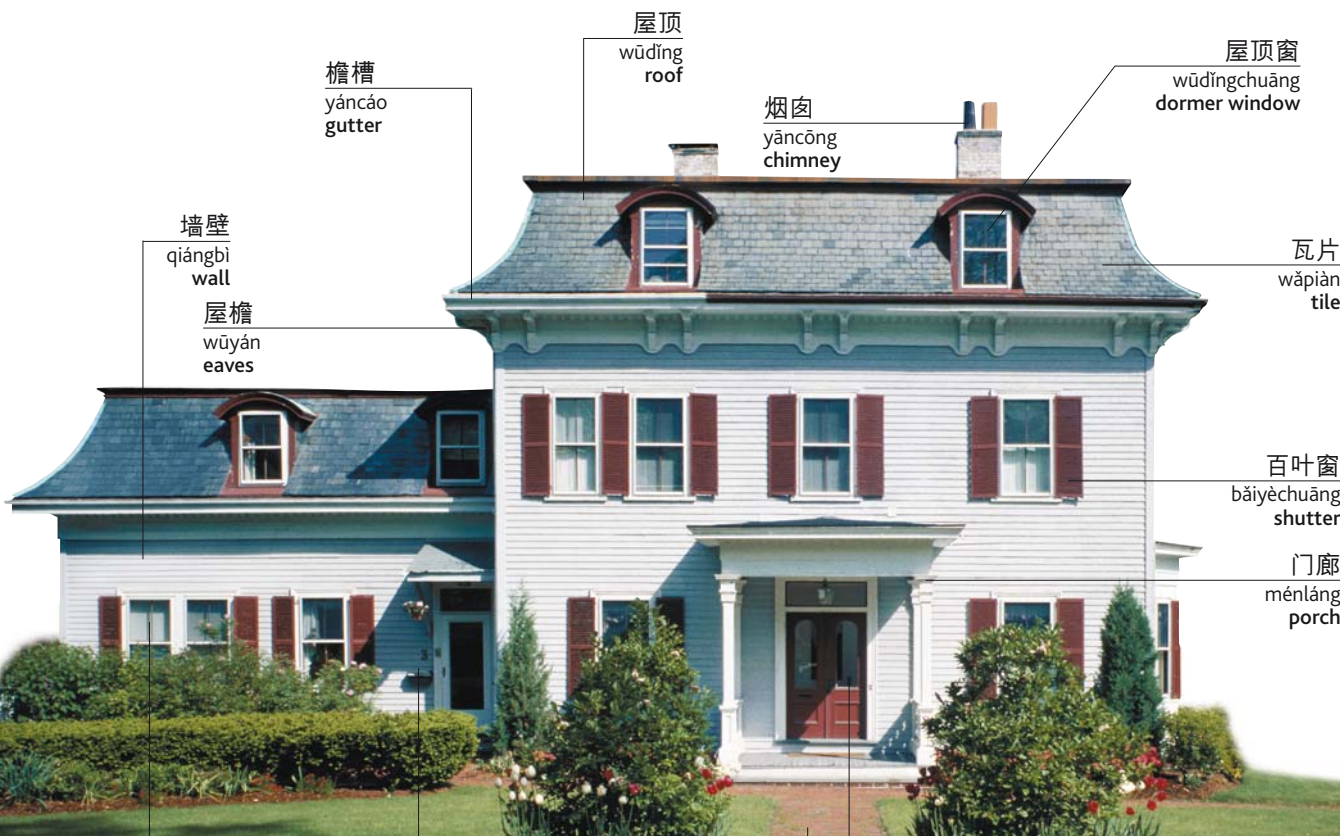

词汇 cíhuì • vocabulary

独立式
dúlìshì
detached

房客
fángkè
tenant

车库
chēkù
garage

信箱
xìnxiāng
letterbox

防盗警报
fángdào jǐngbào
burglar alarm

租用
zūyòng
rent (v)

半独立式
bàndúlìshì
semidetached

平房
píngfáng
bungalow

阁楼
gélóu
attic

门廊灯
ménlángdēng
porch light

庭院
tíngyuàn
courtyard

房租
fángzū
rent

独栋住宅
dúdòngzhùzhái
townhouse

地下室
dìxiàshì
basement

房间
fángjiān
room

房东
fángdōng
landlord

楼层
lóucéng
floor

连排式
liánpáishì
terraced

入口 rùkǒu • entrance

公寓 gōngyù • flat

扶手
fúshǒu
hand rail

楼梯
lóutī
staircase



楼梯平台
lóutī píngtái
landing

楼梯栏杆
lóutī lángān
banister

门厅
méntīng
hallway



门铃
ménlíng
doorbell



门垫
méndiàn
doormat



门环
ménhuán
door knocker



门链
ménliàn
door chain

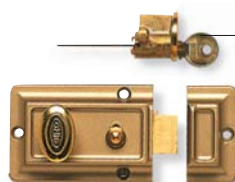

锁
suǒ
lock

钥匙
yàoshi
key



门闩
ménshuān
bolt

阳台
yángtái
balcony



公寓楼
gōngyùlóu
block of flats



对讲器
duìjiǎngqì
intercom



电梯
diàntī
lift

室内系统 shì nèi xì tǒng • internal systems



暖器片
nuǎnqìpiàn
radiator



电暖器
diànnuǎnqì
heater

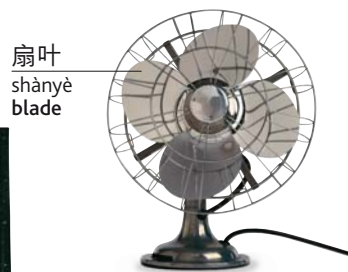

扇叶
shànyè
blade

风扇
fēngshàn
fan



对流式电暖器
duìliúshì diànnuǎnqì
convecter heater

电 diàn • electricity



灯丝
dēngsī
filament

灯泡接口
dēngpào jiēkǒu
bayonet fitting

灯泡 dēngpào | light bulb

接地
jiēdì
earthing

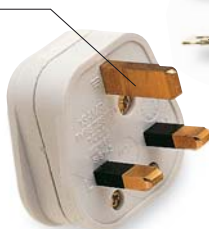

插头 chātóu | plug



插片
chāpiàn
pin

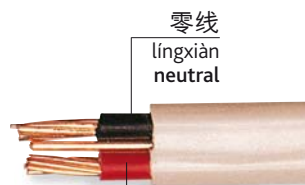

零线
língxiàn
neutral

火线
huǒxiàn
live

电线 diànxian | wires

词汇 cíhuì • vocabulary

电压
diànyǎ
voltage

保险丝
bǎoxiǎnsī
fuse

插座
chāzuò
socket

直流电
zhíliúdiàn
direct current

停电
tíngdiàn
power cut

安培
ānpéi
amp

保险盒
bǎoxiǎnhé
fuse box

开关
kāiguān
switch

变压器
biànyǎqì
transformer

供电系统
gòngdiàn xìtǒng
mains supply

电力
diànlì
power

发电机
fādiànjī
generator

交流电
jiāoliúdiàn
alternating current

电表
diànbǎo
electricity meter

管道装置 guǎndào zhuāngzhì • plumbing

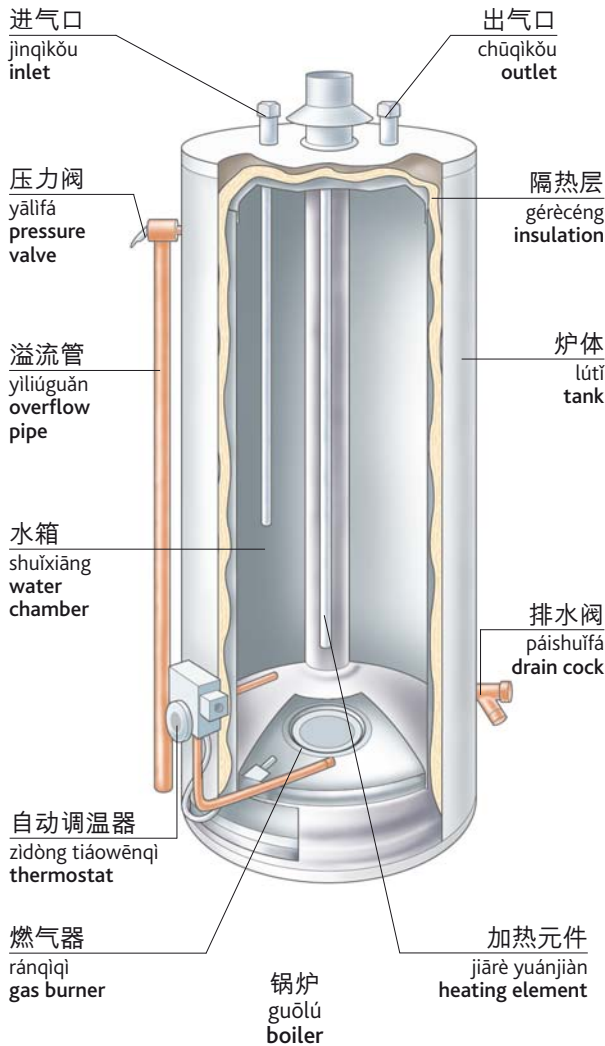

洗涤槽 xǐdí cáo • sink

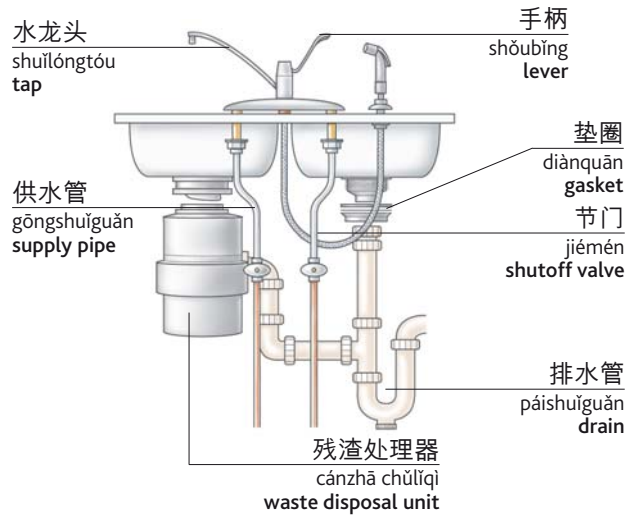

抽水马桶 chōushuǐ mǎtǒng • water closet

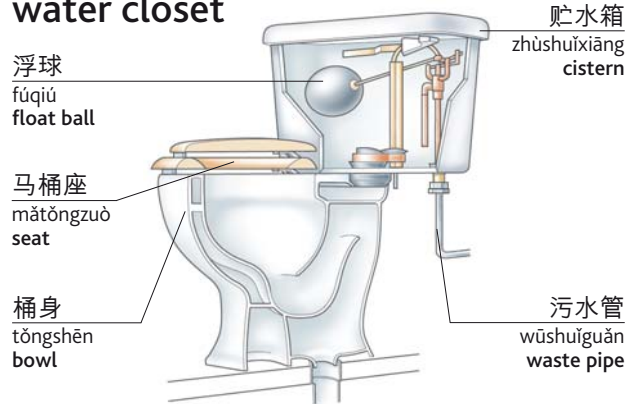

垃圾处理 lājichǔlǐ • waste disposal



起居室 qǐjūshì • living room

画
huà
painting

画框
huàkuàng
frame

灯
dēng
lamp

壁灯
bìdēng
wall light

钟表
zhōngbiǎo
clock

天花板
tiānhuābǎn
ceiling

储物柜
chǔwùguì
cabinet

沙发
shāfā
sofa

靠垫
kàodiàn
cushion

茶几
chájī
coffee table

地板
dìbǎn
floor



镜子
jìngzi
mirror

花瓶
huāpíng
vase

壁炉台
bìlútái
mantelpiece

壁炉
bìlú
fireplace

挡火板
dǎnghuǒbǎn
screen

蜡烛
làzhú
candle

书架
shūjià
bookshelf

沙发床
shāfāchuáng
sofabed

地毯
dìtǎn
rug



窗帘
chuānglián
curtain



窗幔
chuāngmàn
net curtain



百叶窗
bǎiyèchuāng
venetian blind

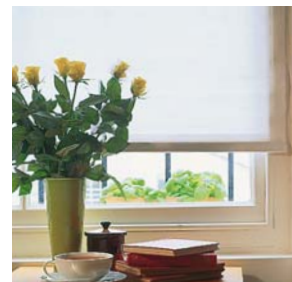

卷帘
juǎnlián
roller blind

装饰脚线
zhuāngshì jiǎoxiàn
moulding

扶手椅
fúshǒuyǐ
armchair



书房 shūfáng | study

餐厅 cāntīng • dining room



词汇 cíhuì • vocabulary

摆桌子
bǎizhuōzi
lay the table (v)

饿
è
hungry

午餐
wǔcān
lunch

饱
bǎo
full

主人
zhǔrén
host

请再给我加一些，好吗？
qǐng zài gěi wǒ jiā yīxiē, hǎoma?
Can I have some more, please?

上菜
shàngcài
serve (v)

桌布
zhuóbù
tablecloth

晚餐
wǎncān
dinner

一份
yīfèn
portion

女主人
nǚzhǔrén
hostess

我吃饱了，谢谢。
wǒ chībǎole, xièxiè.
I've had enough, thank you.

吃
chī
eat (v)

早餐
zǎocān
breakfast

餐具垫
cānjùdiàn
place mat

饭菜
fàncai
meal

客人
kèrén
guest

很好吃。
hěn hào chī.
That was delicious.

餐具 cānjù • crockery and cutlery



马克杯
mǎkèbēi
mug



咖啡杯
kāfēibēi
coffee cup



茶杯
chábēi
teacup

茶匙
cháchí
teaspoon



盘子
pánzi
plate



碗
wǎn
bowl



咖啡壶
kāfēihú
cafetière



茶壶
cháhú
teapot



带柄水壶
dàibǐngshuǐhú
jug



蛋杯
dànbei
egg cup

酒杯
jiǔbēi
wine glass

平底玻璃杯
píngdǐbōlibēi
tumbler



玻璃器皿
bōlibī qìmǐn
glassware

餐巾套环
cānjīn tàohuán
napkin ring

甜点盘
tiándiǎnpán
side plate

正餐用盘
zhèngcān
yòngpán
dinner plate

汤盆
tāngpén
soup bowl

汤匙
tāngchí
soup spoon



餐巾
cānjīn
napkin



餐叉
cānchā
fork



餐具摆放
cānjù bǎifāng
place setting



餐匙
cānchí
spoon

餐刀
cāndāo
knife

厨房 chúfáng • kitchen



厨房电器 chúfáng diànrqì • appliances



制冰室
zhìbīngshì
ice maker

冷冻室
lěngdòngshì
freezer



冰箱
bīngxiāng
refrigerator

搁板
gēbǎn
shelf

蔬菜保鲜格
shūcài bǎoxiāngé
crisper

双门冰箱 shuāngmén bīngxiāng | fridge-freezer

词汇 cíhuì • vocabulary

餐具沥水架
cānjù lishuǐjià
draining board

火炉
huǒlú
burner

炉盘
lúpán
hob

垃圾桶
lājītǒng
rubbish bin

冷冻
lěngdòng
freeze (v)

解冻
jiědòng
defrost (v)

蒸
zhēng
steam (v)

炒
chǎo
sauté (v)

烹饪 pēngrèn • cooking



削皮
xuēpí
peel (v)



切片
qiēpiàn
slice (v)



擦碎
cāsuì
grate (v)



注水
zhùshuǐ
pour (v)



搅拌
jiǎobàn
mix (v)



搅打
jiǎodǎ
whisk (v)



煮沸
zhǔfèi
boil (v)



煎
jiān
fry (v)



擀
gǎn
roll (v)



搅动
jiǎodòng
stir (v)



文火烧，煨，炖
wénhuǒ shāo, wēi, dùn
simmer (v)



沸水煮
fèishuǐzhǔ
poach (v)



烘制
hōngzhì
bake (v)



烤制
kǎozhì
roast (v)



烧烤
shāokǎo
grill (v)

厨具 chújù • kitchenware



案板
ànbǎn
chopping board

面包刀
miànbāodāo
bread knife



厨刀
chúdāo
kitchen knife



切肉刀
qièròudāo
cleaver



磨刀器
módāoqì
knife sharpener



松肉槌
sōngròuchuí
meat tenderizer



串肉扦
chuànròuqiān
skewer



礞床
cǎchuáng
grater



研钵
yánbō
mortar

研杵
yánchǔ
pestle



捣泥器
dǎoníqì
masher



削皮刀
xuēpídao
peeler



苹果去核器
píngguǒ qùhéqì
apple corer



开罐器
kāiguǎnqì
can opener



开瓶器
kāipíngqì
bottle opener



压蒜器
yāsuǎnqì
garlic press



分餐匙
fēncānchí
serving spoon



煎鱼铲
jiānyúchǎn
fish slice



滤锅
lǜguō
colander



刮铲
guāchǎn
spatula



木勺
mùsháo
wooden spoon



漏勺
lòusháo
slotted spoon



长柄勺
chángbǐngsháo
ladle



切肉叉
qièròuchā
carving fork



深口圆匙
shēnkǒu yuánchí
scoop



打蛋器
dǎdànqì
whisk



滤网
lǜwǎng
sieve



蛋糕制作 dàngāo zhìzuò • baking cakes



卧室 wòshì • bedroom

衣橱
yīchú
wardrobe

床头灯
chuángtóudēng
bedside lamp

床头板
chuángtóubǎn
headboard

床头柜
chuángtóugui
bedside table

五斗橱
wūdǒuchú
chest of drawers



抽屉
chōuti
drawer

床
chuáng
bed

床垫
chuángdiàn
mattress

床罩
chuángzhào
bedspread

枕头
zhěntóu
pillow



暖水袋
nuǎnshuǐdài
hot-water bottle



时钟收音机
shízhōng shōuyīnjī
clock radio



闹钟
nàozhōng
alarm clock



纸巾盒
zhǐjīnhé
box of tissues



衣架
yījià
coat hanger

床上用品 chuángshàng yòngpǐn • bed linen



镜子
jìngzi
mirror

梳妆台
shūzhuāngtái
dressing table

地板
dìbǎn
floor



枕套
zhěntào
pillowcase

床单
chuángdān
sheet

床帷
chuángwéi
valance

羽绒被
yǔróngbèi
duvet

棉被
miánbèi
quilt

毯子
tǎnzi
blanket



词汇 cíhuì • vocabulary

单人床
dānrénchuáng
single bed

床脚板
chuángjiǎobǎn
footboard

失眠
shīmián
insomnia

醒来
xǐnglái
wake up (v)

设定闹钟
shèdìng nàozhōng
set the alarm (v)

双人床
shuāngrénchuáng
double bed

弹簧
tánhuáng
spring

上床睡觉
shàngchuáng shuìjiào
go to bed (v)

起床
qǐchuáng
get up (v)

打鼾
dǎhān
snore (v)

电热毯
diànrètǎn
electric blanket

地毯
dìtǎn
carpet

入睡
rùshuì
go to sleep (v)

整理床铺
zhěnglǐ chuángpù
make the bed (v)

内嵌式衣橱
nèiqiànshì yīchú
built-in wardrobe

浴室 yùshì • bathroom

毛巾架
máoījīa
towel rail

淋浴隔门
línǚ gémén
shower door

冷水龙头
lěngshuǐ lóngtóu
cold tap

热水龙头
rèshuǐ lóngtóu
hot tap

淋浴喷头
línǚ pēntóu
shower head

洗手池
xǐshǒuchí
washbasin

塞子
sāizi
plug



浴缸
yùgāng
bathtub



净身盆 jìngshēnpén | bidet



淋浴
línǚ
shower

地漏
dìlòu
drain

马桶座
mǎtǒngzuò
toilet seat

抽水马桶
chōushuǐ mǎtǒng
toilet

马桶刷
mǎtǒngshuā
toilet brush

词汇 cíhuì • vocabulary

家用药箱
jiāyòng yàoxiāng
medicine cabinet

浴室防滑垫
yùshì fǎnghuádiàn
bath mat

卫生纸
wèishēngzhǐ
toilet roll

淋浴隔帘
línǚ gélián
shower curtain

洗淋浴
xǐlínǚ
take a shower (v)

洗澡
xǐzǎo
take a bath (v)

口腔卫生 kǒuqiāng wèishēng • dental hygiene



牙刷
yáshuā
toothbrush



牙线
yáxiàn
dental floss



牙膏
yágāo
toothpaste



漱口水
shùkǒuǒyè
mouthwash



丝瓜络
sīguāluò
loofah

海绵
hǎimián
sponge



浮石
fúshí
pumice stone



背刷
bèishuā
back brush



除臭剂
chúchòuji
deodorant

肥皂盒
féizǎohé
soap dish



肥皂
féizào
soap

沐浴乳
mùyǔrǔ
shower gel



面霜
miànshuāng
face cream



泡泡浴液
pàopào yùyè
bubble bath



浴袍
yùpáo
bathrobe

擦手巾
cāshǒujīn
hand towel



毛巾
máojīn
towels

浴巾
yùjīn
bath towel



润肤露
rùnfúlù
body lotion



爽身粉
shuǎngshēnfěn
talcum powder

剃须 tìxū • shaving



电动剃须刀
diàndòng tìxūdāo
electric razor



剃须泡沫
tìxūpàomò
shaving foam



一次性剃须刀
yícìxìng tìxūdāo
disposable razor



剃刀刀片
tìdāo dāopiàn
razor blade



须后水
xūhòushuǐ
aftershave

育婴室 yùyīngshì • nursery

婴儿护理 yīng'ér hùlǐ • baby care



海绵
hǎimián
sponge

尿疹膏
niàozhēngāo
nappy rash cream

婴儿浴盆
yīng'ér yùpén
baby bath



湿纸巾
shīzhǐjīn
wet wipe



婴儿便盆
yīng'ér biànpén
potty



换衣垫
huànyīdiàn
changing mat

睡眠 shuìmián • sleeping

活动玩具
huódòng wánjù
mobile



床垫
chuángdiàn
mattress
婴儿床 yīng'érchuáng | cot

床单
chuángdān
sheet

栏杆
lángān
bars

羊毛毯
yángmáotǎn
fleece

护围
hùwéi
bumper



拨浪鼓
bōlàngǔ
rattle

毯子
tǎnzi
blanket



被褥
bèirù
bedding



婴儿睡篮
yīng'ér shuìlán
moses basket

游戏 yóuxì • playing



安全 ānquán
• safety



饮食 yǐnshí
• eating



外出 wàichū • going out



洗衣间 xǐyījiān • utility room

洗涤 xǐdí • laundry

脏衣物
zāngyīwù
dirty washing



洗衣篮
xǐyīlán
laundry basket



洗衣机
xǐyījī
washing machine



洗衣干衣机
xǐyī gānyījī
washer-dryer



滚筒式烘干机
gǔntǒngshì hōnggānjī
tumble dryer

干净衣物
gānjìng yīwù
clean clothes



衣物篮
yīwùlán
linen basket

衣服夹
yīfújiá
clothes peg



晾干
liàngān
dry (v)

晾衣绳
liàngyīshéng
clothes line



熨衣板 yùnyībǎn | ironing board



熨斗
yùndǒu
iron

词汇 cíhuì • vocabulary

装入
zhuāngrù
load (v)

甩干
shuǎigàn
spin (v)

熨烫
yùntàng
iron (v)

洗衣机怎么用?
xǐyījī zěnmeyòng?
How do I operate the washing machine?

漂洗
piǎoxǐ
rinse (v)

甩干机
shuǎigānjī
spin dryer

织物柔顺剂
zhīwù róushùnjì
fabric conditioner

如何设定洗染色/白色衣物?
rúhé shèdìng xǐ rǎnsè/báisè yīwù?
What is the setting for coloureds/whites?

清洁用具 qīngjiéyòngjù • cleaning equipment



扫除 sāochú • activities



工作间 gōngzuòjiān • workshop



镂花锯
lòuhuājù
jigsaw



电池盒
diànchíhé
battery pack

充电式电钻
chōngdiànshì diànzuàn
rechargeable drill

钻夹头
zuànjiátóu
chuck



电钻
diànzuàn
electric drill



先端部钻头
xiānduānbù
zuàntóu



胶枪
jiāoqiāng
glue gun

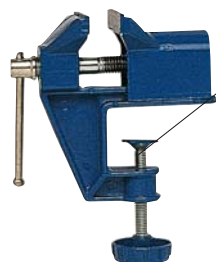

台钳
táiqián
vice



夹钳
jiáqián
clamp

打磨机
dǎmóji
sander

刃
rèn
blade

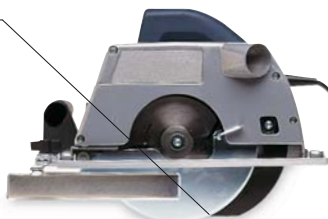

圆锯
yuánjù
circular saw



工作台
gōngzuòtái
workbench

木材胶
mùcáijiāo
wood glue

槽刨
cáopáo
router

刨花
bào huā
wood shavings



工具架
gōngjùjià
tool rack

手摇曲柄钻
shǒuyáo
qūbǐngzuàn
bit brace

电源箱延长线
diànyuánxiāng
yǎnchángxiàn
extension lead

技艺 jìyì • techniques



切割
qiēgē
cut (v)



锯
jù
saw (v)



钻孔
zuànkǒng
drill (v)



钉
dīng
hammer (v)



刨 páo | plane (v)



车削 chēxiāo | turn (v)

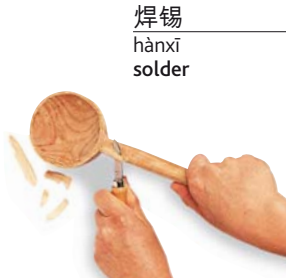

焊锡
hànxi
solder
雕刻 diāokè | carve (v)

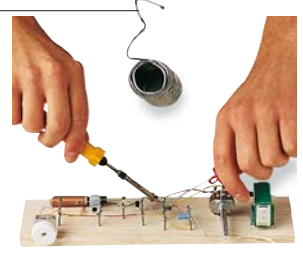

焊接 hànjiē | solder (v)

材料 cáiliào • materials

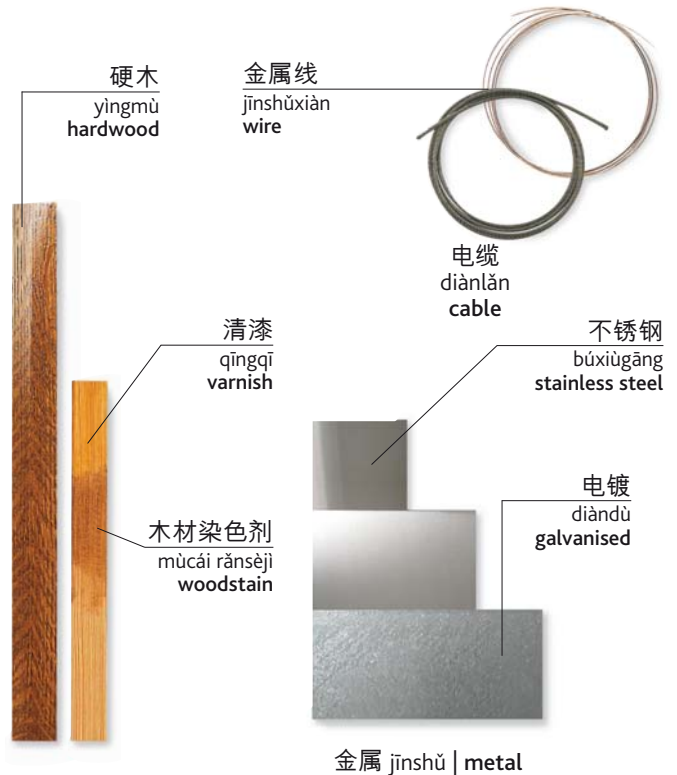
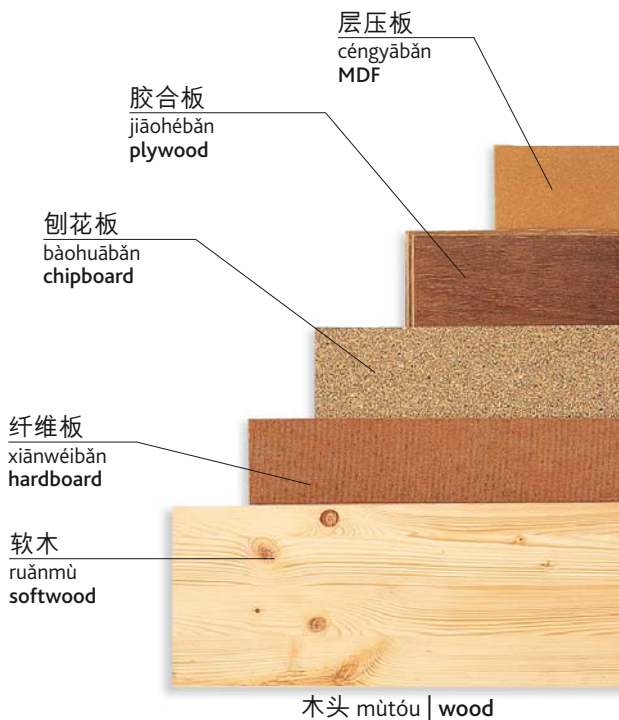

工具箱 gōngjùxiāng • toolbox

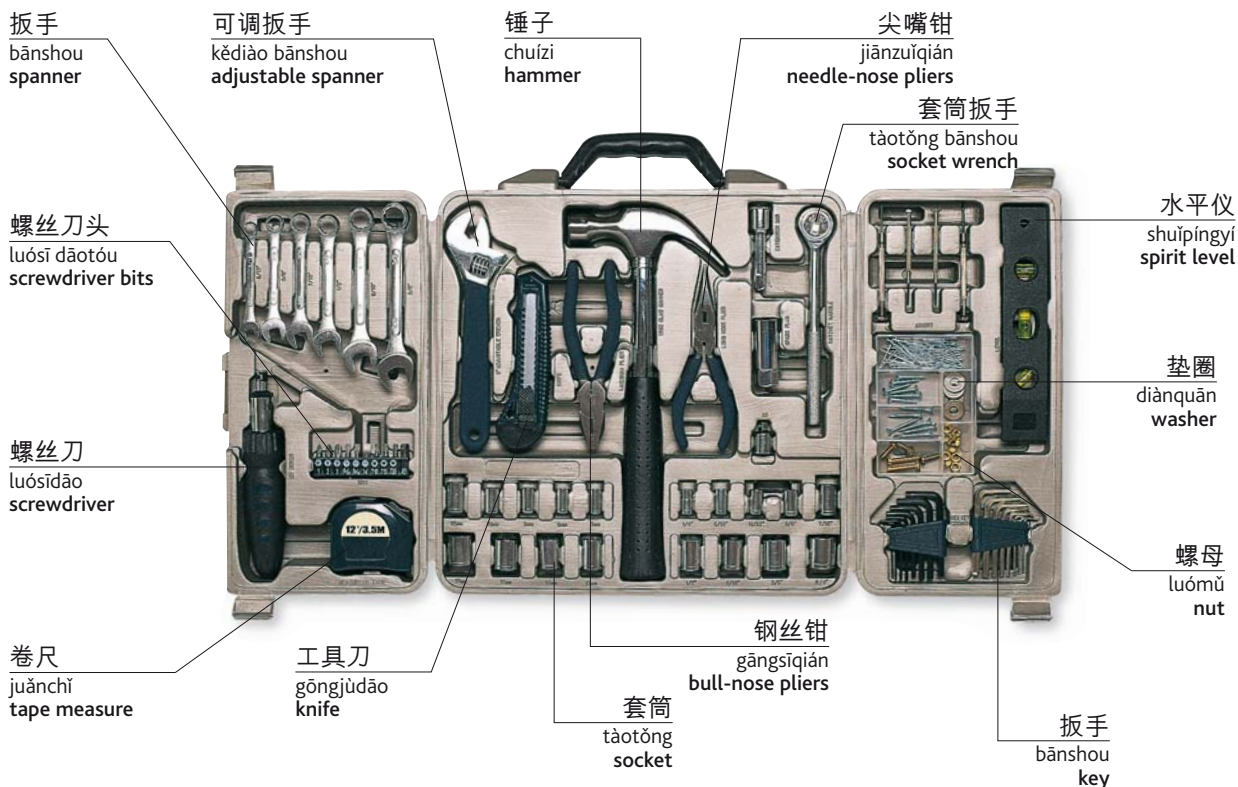

钻头 zuàntóu • drill bits

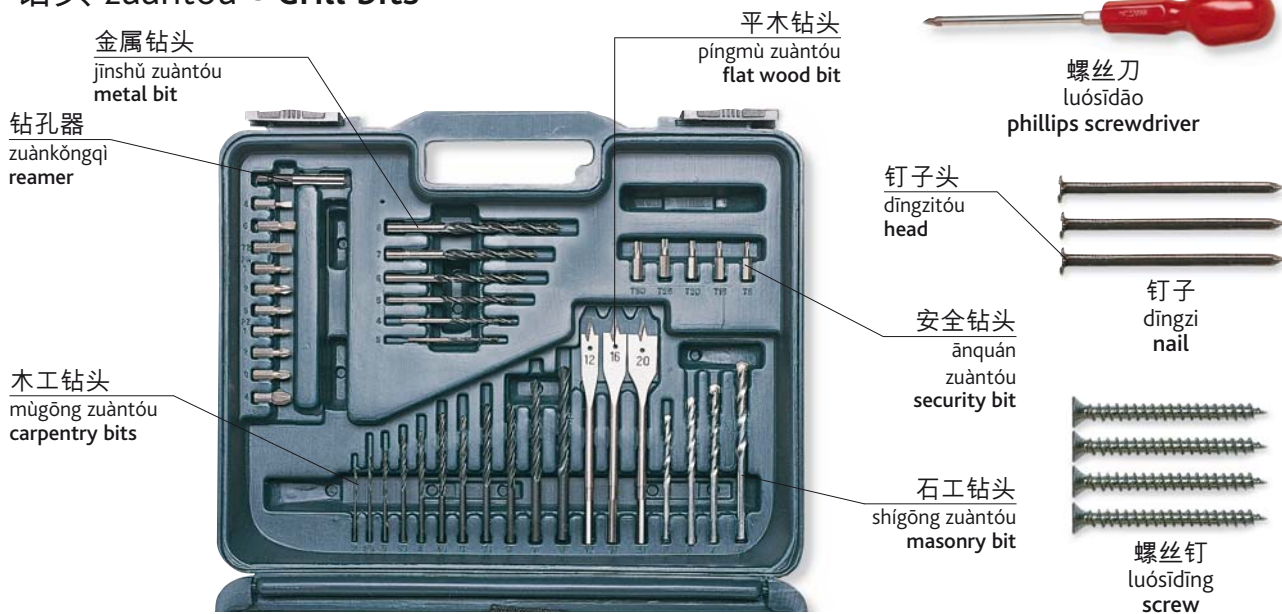

剥皮钳
bāopíqiǎn
wire strippers

铁丝剪
tiěsījiǎn
wire cutters

烙铁
làotie
soldering iron

绝缘胶带
juéyuán
jiāodài
insulating
tape

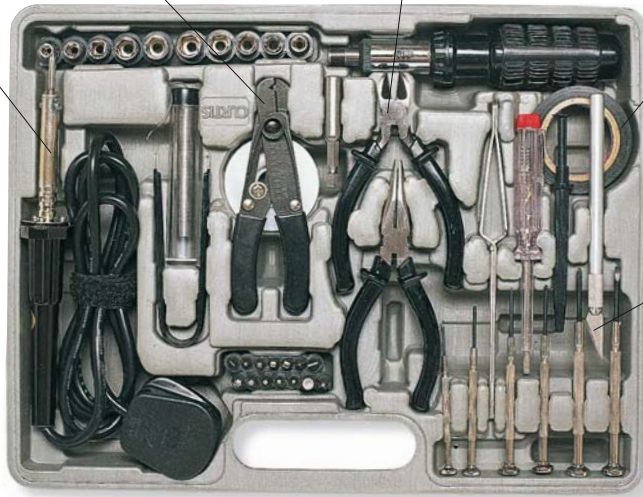

切割刀
qiēgēdāo
scalpel

线锯
xiànjù
fretsaw

焊锡
hànxi
solder



开榫锯 kāisǔnjù | tenon saw



护目镜
hùmùjǐng
safety goggles



刨子
bàozi
plane



手锯
shǒujù
handsaw



手摇钻
shǒuyáozuàn
hand drill



钢丝绒
gāngsīróng
wire wool

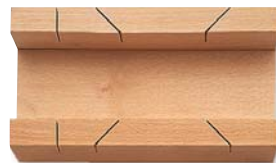

斜锯架
xiéjùjià
mitre block



钢锯
gāngjù
hacksaw



砂纸
shāzhǐ
sandpaper

扳钳
bānqiǎn
wrench



凿子
záozi
chisel



磨刀石
módao shí
sharpening stone



锉刀
cuòdāo
file



切管机 qiēguǎnjī | pipe cutter

搯子
chuāizi
plunger

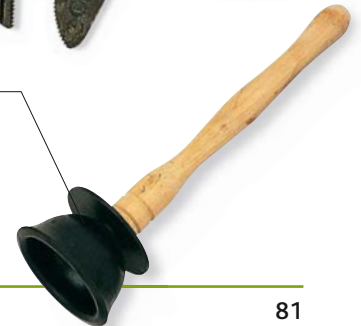

装修 zhuāngxiū • decorating



剪刀
jiǎndāo
scissors



工艺刀
gōngyidāo
craft knife



铅锤线
qiānchuíxiàn
plumb line



刮刀
guādāo
scraper

裱糊匠
biǎohújiàng
decorator

壁纸
bìzhǐ
wallpaper

折梯
zhétī
stepladder



裱糊刷
biǎohúshuā
wallpaper brush

裱糊台
biǎohútái
pasting table

上浆刷
shàngjiāngshuā
pasting brush

壁纸黏合剂
bìzhǐ niánhéjī
wallpaper paste

桶
tǒng
bucket

贴壁纸 tiēbìzhǐ | wallpaper (v)



铲掉 chǎndiào | strip (v)



抹 mǒ | fill (v)



用砂纸打磨 yòng shāzhǐ dǎmó
sand (v)



粉刷 fēnshuā | plaster (v)



贴(墙纸) tiē(qiángzhǐ) | hang (v)



铺砖 pūzhuān | tile (v)



刷漆 shuāqī | paint (v)

油漆滚筒
yóuqī gǔntǒng
roller



油漆盘
yóuqīpán
paint tray



油漆
yóuqī
paint

刷子
shuāzi
brush



海绵
hǎimián
sponge



遮蔽胶带
zhēbì jiāodài
masking tape



砂纸
shāzhǐ
sandpaper

油漆桶
yóuqītǒng
paint tin

工装裤
gōngzhuāngkù
overalls

防尘布
fángchénbù
dustsheet



松节油
sōngjiéyóu
turpentine

填料
tiánliào
filler



稀释剂
xīshìjì
white spirit



词汇 cíhuì • vocabulary

石膏
shígāo
plaster

有光泽
yǒuguāngzé
gloss

压花纸
yāhuāzhǐ
embossed paper

内涂层
nèitúcéng
undercoat

密封胶
mìfēngjì
sealant

清漆
qīngqī
varnish

无光泽
wúguāngzé
mat

衬纸
chènzhǐ
lining paper

外涂层
wàitúcéng
top coat

溶剂
róngjì
solvent

无光漆
wúguāngqī
emulsion

花样模板
huāyàng múbǎn
stencil

底漆
dǐqī
primer

防腐剂
fángfǔjì
preservative

薄胶浆
báojiāojiāng
grout

花园 huāyuán • garden

花园风格 huāyuánfēnggé • garden styles



内院 nèiyuàn | patio garden



屋顶花园
wūdǐng huāyuán
roof garden



岩石园
yánshíyuán
rock garden



庭院 tíngyuàn | courtyard



法式花园 fàshì huāyuán | formal garden



乡间花园
xiāngjiān huāyuán
cottage garden



香草花园
xiāngcǎo huāyuán
herb garden



水景花园
shuǐjǐng huāyuán
water garden

花园装饰 huāyuán zhuāngshì • garden features



吊篮
diàolán
hanging basket



花格屏 huāgéping | trellis



藤架
téngjià
pergola

土壤 tǔrǎng ● soil

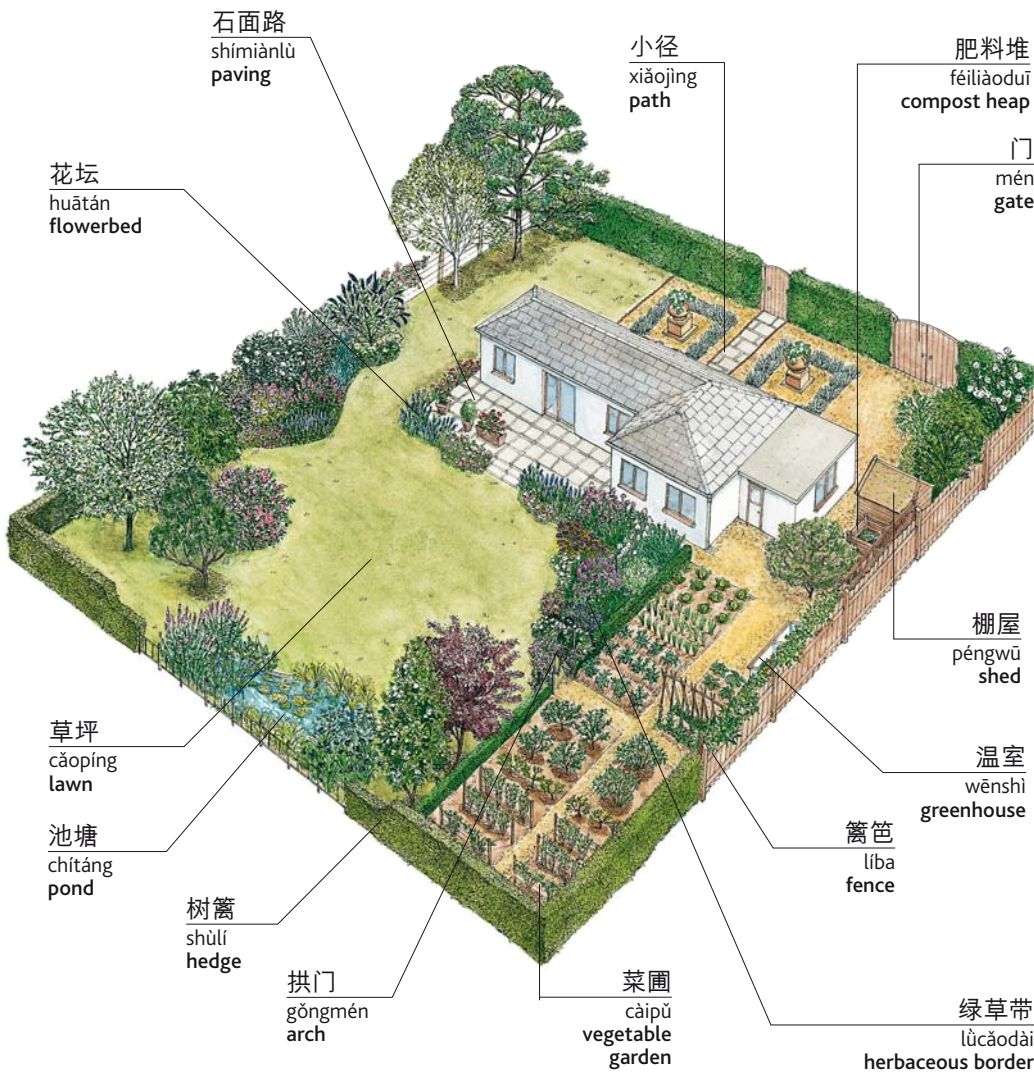

表层土 biǎocéngtǔ
topsoil



沙土 shātǔ
sand



石灰石 shíhuīshí
chalk



淤泥 yūní
silt



黏土 niántǔ
clay



铺面 pùmiàn
decking



喷泉 pēnquán | fountain

花园植物 huāyuánzhíwù • garden plants

植物种类 zhíwùzhǒnglèi • types of plants



一年生(植物)
yīniánshēng (zhíwù)
annual



二年生(植物)
èrniánshēng (zhíwù)
biennial



多年生(植物)
duōniánshēng (zhíwù)
perennial



球茎植物
qiújīng zhíwù
bulb

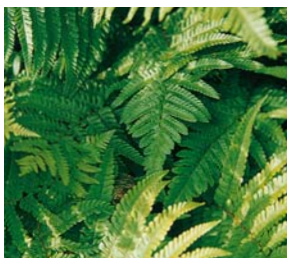

蕨类植物
juélèi zhíwù
fern



灯心草
dēngxīncǎo
rush



竹子
zhúzi
bamboo



杂草
zácǎo
weeds



药草
yàocǎo
herb



水生植物
shuǐshēng zhíwù
water plant



树
shù
tree



落叶(植物)
luòyè (zhíwù)
deciduous



棕榈
zōnglǚ
palm



针叶树
zhēnyèshù
conifer



常绿(植物)
chánglǜ (zhíwù)
evergreen



灌木修剪
guànmù xiūjiǎn
topiary



高山植物
gāoshān zhíwù
alpine



肉质植物
ròuzhì zhíwù
succulent



仙人掌
xiānrénzhǎng
cactus

盆栽植物
pénzāi zhíwù
potted plant

阴地植物
yīndì zhíwù
shade plant

攀缘植物
pānyuán zhíwù
climber

开花灌木
kāihuā guànmù
flowering shrub

地被植物
dìbèi zhíwù
ground cover



匍匐植物
púfú zhíwù
creeper

观赏(植物)
guānshǎng
(zhíwù)
ornamental

草
cǎo
grass

园艺工具 yuányì gōngjù • garden tools



铲
chǎn
spade



叉
chā
fork



长柄修篱剪
chángbǐng xiūlíjiǎn
long-handled shears



搂草耙
lōucǎopá
lawn rake



耙子
pázi
rake



锄头
chútou
hoe



堆肥
duīfēi
compost



种子
zhǒngzi
seeds



骨粉
gǔfěn
bone meal



碎石
suìshí
gravel



草袋
cǎodài
grass bag

马达
mǎdá
motor

把手
bǎshǒu
handle

防护盘
fánghùpán
shield

修剪器
jiǎncǎoqì
trimmer

除草机
jiǎncǎojī
lawnmower



浅底篮
qiǎndǐlán
trug



支架
zhījià
stand

独轮手推车
dúlún shǒutuìchē
wheelbarrow



浇灌 jiāoguàn • watering



园艺 yuányì • gardening

草地
cǎodì
lawn

花坛
huātán
flowerbed

割草机
gēcǎojī
lawnmower



树篱
shùlǐ
hedge

树木支柱
shùmù zhīzhūāng
stake

割草 gēcǎo | mow (v)

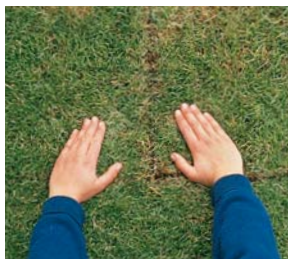

铺草皮
pūcǎopí
turf (v)



钉
dīng
spike (v)



耙
pá
rake (v)



修枝
xiūzhī
trim (v)



挖
wā
dig (v)



播种
bōzhǒng
sow (v)



土表施肥
tǔbiǎo shīféi
top dress (v)



浇水
jiāoshuǐ
water (v)



整枝
zhěngzhī
train (v)



摘除枯花
zhāichú kūhuā
deadhead (v)

喷水
pēnshuǐ
spray (v)



支撑杆
zhīchēnggān
cane



嫁接
jiàjiē
graft (v)



插条
chātiao
cutting

插枝
chāzhī
propagate (v)

修剪
xiūjiǎn
prune (v)

用杆支撑
yònggān zhīchēng
stake (v)



移植
yízhí
transplant (v)



清除杂草
qīngchú zácao
weed (v)



加护盖物
jiā hùgàiwù
mulch (v)

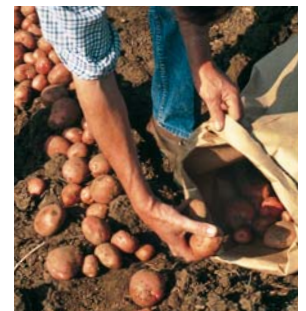

收获
shōuhuò
harvest (v)

词汇 cíhuì • vocabulary

栽培
zāipéi
cultivate (v)

园艺设计
yuányì shèjì
landscape (v)

施肥
shīféi
fertilize (v)

筛
shāi
sieve (v)

有机(栽培)的
yǒuji(zāipéi)de
organic

秧苗
yāngmiáo
seedling

底土
dītǔ
subsoil

护理
hùlǐ
tend (v)

把...种于盆内
bǎ...zhòng yú
pénnei
pot up (v)

采摘
cǎizhāi
pick (v)

松土
sōngtǔ
aerate (v)

排水
páishuǐ
drainage

肥料
féiliào
fertilizer

除草剂
chúcǎoji
weedkiller



2

JKL

5

TUV

7

8

SYMBOL

0



服务 fúwù
services

急救 jǐjiù • emergency services

救护车 jiùhùchē • ambulance



救护车 jiùhùchē | ambulance



担架
dānjià
stretcher

急救人员 jǐjiù rényuán | paramedic

警察 jǐngchá • police

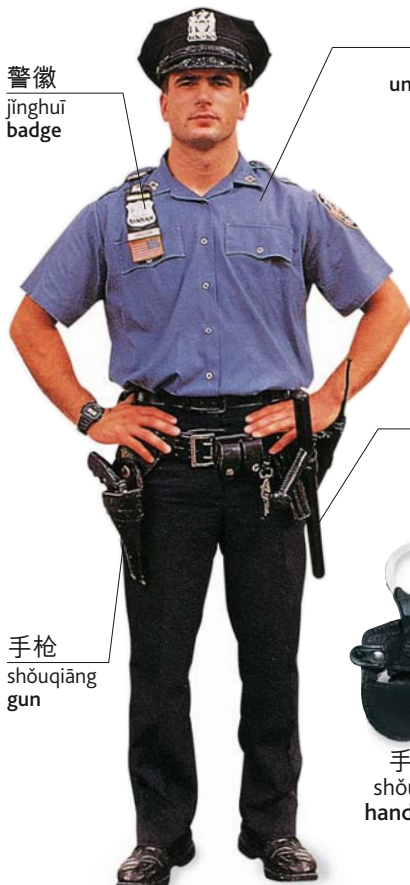

警徽
jǐnghuī
badge

制服
zhìfú
uniform

警笛
jǐngdí
siren

警灯
jǐngdēng
lights



警车
jǐngchē
police car



警察局
jǐngchájú
police station

警棍
jǐnggùn
truncheon



手铐
shǒukào
handcuffs

手枪
shǒuqiāng
gun

警官 jǐngguān | police officer

词汇 cíhuì • vocabulary

探员
tànyuán
inspector

嫌疑犯
xiányifàn
suspect

起诉
qǐsù
complaint

逮捕
dàibǔ
arrest

罪行
zuìxíng
crime

攻击
gōngjī
assault

调查
diàochá
investigation

单人牢房
dānrén láofáng
police cell

侦探
zhēntàn
detective

指纹
zhǐwén
fingerprint

入室盗窃
rùshì dàoqiè
burglary

控告
kònggào
charge

消防队 xiāofángduì • fire brigade



火情 huǒqíng | fire



消防站
xiāofángzhàn
fire station



消防通道
xiāofángtōngdào
fire escape



消防车
xiāofángchē
fire engine



烟雾报警器
yānwù bàojǐngqì
smoke alarm



火灾报警器
huǒzāi jǐngbàoqì
fire alarm



消防斧
xiāofángfǔ
axe



灭火器
mièhuǒqì
fire extinguisher



消防栓
xiāofángshuān
hydrant

我需要警察/消防队/救护车。
wǒ xūyào jǐngchá/xiāofángduì/jiùhùchē.
I need the police/fire brigade/
ambulance.

在...有火情。
zài...yǒu huǒqíng.
There's a fire at...

发生了事故。
fāshēngle shìgù.
There's been an accident.

报警!
bàojǐng!
Call the police!

银行 yínháng • bank

客户
kèhù
customer

窗口
chuāngkǒu
window

出纳员
chūnàyuán
cashier



宣传页
xuānchuányè
leaflets

柜台
guìtái
counter

存款单
cúnkùndān
paying-in slips



银行经理
yínháng jīnglǐ
bank manager

银行卡
yínhángkǎ
debit card



信用卡
xìnyòngkǎ
credit card

支票存根
zhǐpiào
cúngēn

账号
zhàngào
account number

签名
qiānmíng
signature

金额
jīn'é
amount



支票簿
zhǐpiàobù
chequebook

支票
zhǐpiào
cheque

词汇 cíhuì • vocabulary

储蓄
chǔxù
savings

抵押贷款
dīyā dàikuǎn
mortgage

付款
fùkuǎn
payment

存入
cúnrù
pay in (v)

活期存款账户
huóqīcúnkǎn zhàngù
current account

税
shuì
tax

透支
tòuzhī
overdraft

直接借记
zhíjiē jièjì
direct debit

银行手续费
yínháng shǒuxùfèi
bank charge

储蓄账户
chǔxù zhàngù
savings account

贷款
dàikuǎn
loan

利率
lǐlǜ
interest rate

取款单
qǔkuǎndān
withdrawal slip

银行转账
yínháng zhuǎnzhang
bank transfer

密码
mímǎ
pin number

硬币
yingbi
coin



货币 huòbì | money

纸币
zhǐbì
note

屏幕
píngmù
screen

按键区
ànjiànqū
key pad



提款机 tíkuǎnjī | cash machine

插卡口
chākǎkǒu
card slot

外币 wàibì • foreign currency



外币兑换处
wàibì duìhuànchù
bureau de change



旅行支票
lǚxíng zhīpiào
traveller's cheque



汇率
huìlǜ
exchange rate

词汇 cíhuì • vocabulary

兑现
duìxiàn
cash (v)

货币面额
huòbì miàné
denomination

佣金
yòngjīn
commission

投资
tóuzī
investment

证券
zhèngquàn
stocks

股份
gǔfèn
shares

股息
gǔxī
dividends

会计师
kuàijìshī
accountant

有价证券组合
yǒujià zhèngquàn zǔhé
portfolio

股权
gǔquán
equity

我能兑换吗？
wǒ néng duìhuàn ma?
Can I change this please?

今天的汇率是多少？
jīntiān de huìlǜ shì duōshǎo?
What's today's exchange rate?

金融 jīnróng • finance

股票价格
gǔpiào jiàgé
share price

股票经纪人
gǔpiào jīngjìrén
stockbroker



投资顾问
tóuzī gǔwèn
financial advisor



证券交易所 zhèngquàn jiāoyìsuǒ
stock exchange

通讯 tōngxùn • communications

邮局职员
yóujú zhíyuán
postal worker

窗口
chuāngkǒu
window

秤
chèng
scales

柜台
guìtái
counter



邮局 yóujú | post office



邮递员
yóudìyuán
postman

邮戳
yóuchuō
postmark

邮票
yóupiào
stamp

邮政编码
yóuzhèngbiānmǎ
postal code

地址
dìzhǐ
address



信封 xìnfēng | envelope

词汇 cíhuì • vocabulary

信
xìn
letter

寄信人地址
jìxìnrén dìzhǐ
return address

递送
dìsòng
delivery

易损坏
yìsǔnhuài
fragile

勿折
wùzhé
do not bend (v)

航空邮件
hángkōng yóujiàn
by airmail

签名
qiānmíng
signature

汇票
huìpiào
postal order

邮袋
yóudài
mailbag

此面向上
cǐmiàn xiàngshàng
this way up

挂号邮件
guàhào yóujiàn
registered post

(从邮筒中)取信
(cóng yóutǒng zhōng) qǔxìn
collection

邮资
yóuzī
postage

电报
diànbào
telegram

传真
chuánzhēn
fax



邮筒
yóutǒng
postbox



信箱
xìnxiāng
letterbox



包裹
bāoguǒ
parcel



速递
sùdì
courier

电话 diànhuà • telephone

话机
huàjī
handset

机座
jīzuò
base station



无绳电话
wúshéng diànhuà
cordless phone

答录机
dálùjī
answering machine



可视电话
kěshìdiànhuà
video phone



电话亭
diànhuàtíng
telephone box



移动电话
yí dòng diànhuà
mobile phone

按键区
ànjiànqū
keypad

听筒
tīngtǒng
receiver

退币口
tuìbīkǒu
coin return



投币电话
tóubìdiànhuà
coin phone



磁卡电话
cíkǎdiànhuà
card phone

词汇 cíhuì • vocabulary

电话号码查询台
diànhuàhào mácháxúntái
directory enquiries

接听电话
jiētīng diànhuà
answer (v)

接线员
jiēxiànyuán
operator

你能告诉我...的号码吗?
nǐ néng gàosù wǒ...de hàomǎ ma?
Can you give me the number for...?

对方付费电话
duìfāng fùfèi diànhuà
reverse charge call

文字讯息
wénzì xùnxī
text message

占线
zhànxiàn
engaged/busy

...的拨叫号码是多少?
...de bōjiào hàomǎ shì duōshǎo?
What is the dialling code for...?

拨号
bōhào
dial (v)

语音讯息
yǔyīn xùnxī
voice message

断线
duànxiàn
disconnected

旅馆 lǚguǎn • hotel

大厅 dàitīng • lobby



接待总台 jiēdài zǒngtái | reception



搬运工 bānyùngōng | porter

行李 xíngli
luggage

行李车 xínglichē
trolley



电梯 diàntī | lift



房间号码 fángjiān hàomǎ
room number

房间 fángjiān • rooms



单人间 dānrénjiān
single room



双人间 shuāngrénjiān
double room



标准间 biāozhǔnjiān
twin room



专用浴室 zhuān yòngyùshì
private bathroom

服务 fúwù • services



客房清洁服务
kèfáng qīngjié fúwù
maid service



洗衣服务
xǐyī fúwù
laundry service

早餐盘

zǎocānpán
breakfast tray



房间送餐服务 fángjiān sòngcān fúwù | room service



小冰箱
xiǎobīngxiāng
mini bar



餐厅
cāntīng
restaurant



健身房
jiànshēnfáng
gym



游泳池
yóuyǒngchí
swimming pool

词汇 cíhuì • vocabulary

提供住宿和早餐
tígōng zhùsù hé zǎocān
bed and breakfast

供应三餐
gōngyīng sāncān
full board

半食宿
bànshíù
half board

有空房间吗？
yǒu kōng fángjiān ma?
Do you have any vacancies?

我预定了房间。
wǒ yùdìng le fángjiān.
I have a reservation.

我想要一个单人间。
wǒ xiǎngyào yīgè dānrénjiān,
I'd like a single room.

我要一个房间，住三天。
wǒ yào yīgè fángjiān, zhù sāntiān.
I'd like a room for three nights.

住一晚多少钱？
zhù yíwǎn duōshǎoqián?
What is the charge per night?

我什么时候得腾房？
wǒ shénme shíhòu děi téng fáng?
When do I have to vacate the room?





购物 gòuwù
shopping

购物中心 gòuwùzhōngxīn • shopping centre

大厅
dàtīng
atrium

招牌
zhāopái
sign

电梯
diàntī
lift



三层
sāncéng
second floor

二层
èrcéng
first floor

自动扶梯
zìdòng fútī
escalator

一层
yīcéng
ground floor

顾客
gùkè
customer

词汇 cíhuì • vocabulary

儿童用品部
értóng yòngpǐnbù
children's department

购物指南
gòuwù zhǐnán
store directory

更衣室
gēngyīshì
changing rooms

这个多少钱？
zhège duōshǎo qián?
How much is this?

箱包部
xiāngbāobù
luggage department

售货员
shòuhuòyuán
sales assistant

婴儿间
yīngérjiān
baby changing facilities

我可以换一件吗？
wǒ kěyǐ huàn yījiàn ma?
May I exchange this?

鞋靴部
xiéxuēbù
shoe department

客户服务
kèhù fúwù
customer services

卫生间
wèishēngjiān
toilets

百货商店 bǎihuò shāngdiàn • department store



男装
nánzhuāng
men's wear



女装
nǚzhuāng
women's wear



女用内衣
nǚyòng nèiyī
lingerie



香水
xiāngshuǐ
perfumery



美容用品
měiróng yòngpǐn
beauty



家用纺织品
jiāyòng fāngzhǐpǐn
linen



家具
jiājù
home furnishings



缝纫用品
féngrièn yòngpǐn
haberdashery



厨房用品
chúfáng yòngpǐn
kitchenware



瓷器
cíqì
china



电子产品
diànzǐ chǎnpǐn
electrical goods



灯具
dēngjù
lighting



体育用品
tǐyù yòngpǐn
sports



玩具
wánjù
toys



文具
wénjù
stationery



食品
shípǐn
food hall

超级市场 chāojí shìchǎng • supermarket

过道
guòdào
aisle

货架
huòjiǎ
shelf

传送带
chuánsòngdài
conveyer belt

收银员
shōuyínyuán
cashier

促销海报
cùxiāo hǎibào
offers



收款台 shōukuǎntái | checkout

顾客
gùkè
customer

收款机
shōukuǎnjī
till

购物袋
gòuwùdài
shopping bag



购物车 gòuwùchē | trolley

食品杂货
shípín zǎhuò
groceries

提手
tíshǒu
handle



购物篮 gòuwùlán | basket



条形码
tiáoxíngmǎ
bar code



条形码扫描器 tiáoxíngmǎ
sàomiáosǎn | scanner



烘烤食品
hōngkǎo shí pǐn
bakery



乳制品
rǔzhǐ pǐn
dairy



早餐麦片
zǎocān mài piàn
breakfast cereals



罐装食品
guǎn zhuāng shí pǐn
tinned food



甜食
tiánshí
confectionery



蔬菜
shūcài
vegetables



水果
shuǐguǒ
fruit



肉禽
ròuqín
meat and poultry



鱼
yú
fish



熟食
shúshí
deli



冷冻食品
lěngdòng shí pǐn
frozen food



方便食品
fāngbiàn shí pǐn
convenience food



饮料
yǐnliào
drinks



家庭日用品
jiā tíng rì yòng pǐn
household products



化妆品
huà zhuāng pǐn
toiletries



婴儿用品
yīng ér yòng pǐn
baby products



家用电器
jiā yòng diàn qì
electrical goods



宠物饲料
chǒng wù sī liào
pet food



杂志 zázhì | magazines

药店 yàodiàn • chemist

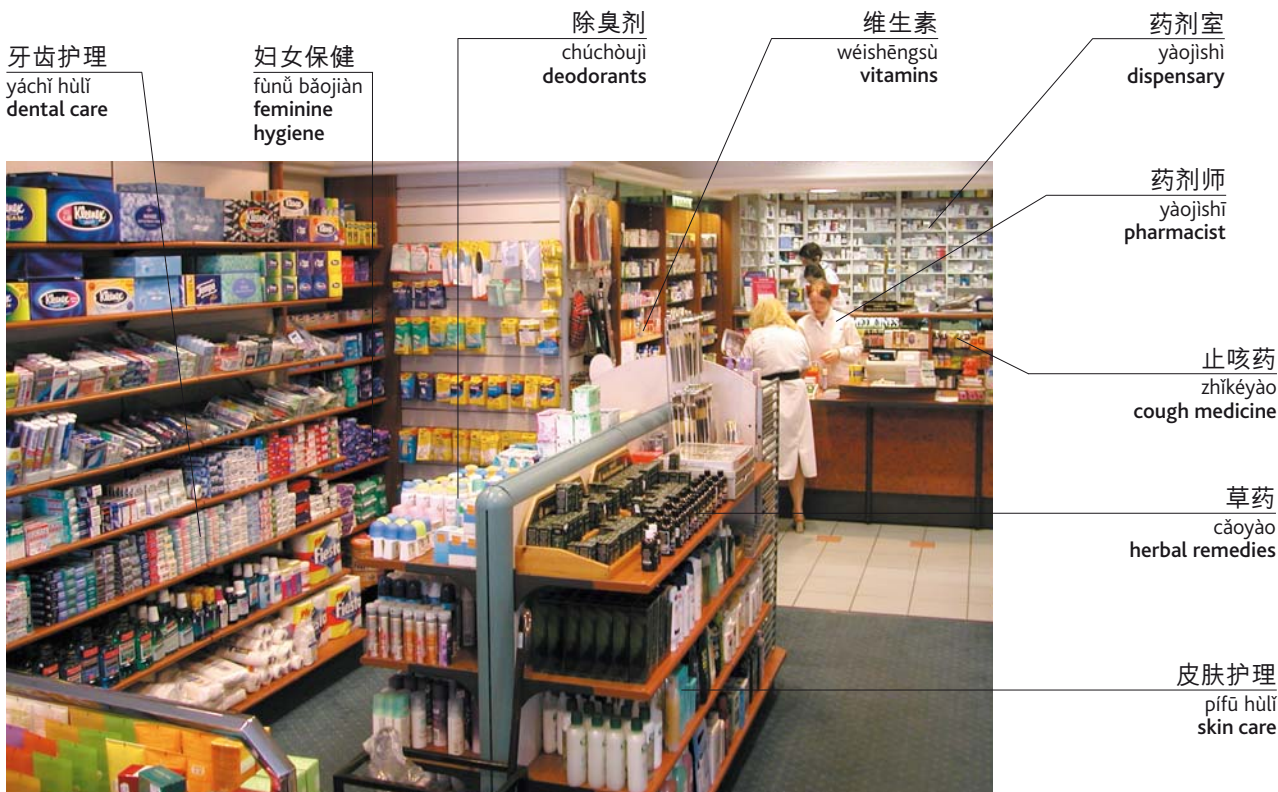



胶囊
jiāonáng
capsule



药片
yàopiàn
pill

量匙
liàngchí
measuring spoon



糖浆
tángjiāng
syrup

使用说明
shǐyòng shuōmíng
instructions



吸入器
xīrùqì
inhaler



霜剂
shuāngjì
cream



软膏
ruǎngāo
ointment



凝胶
níngjiāo
gel



栓剂
shuānjì
suppository



滴剂
dījì
drops

滴管
dīguǎn
dropper



注射器
zhùshèqì
syringe

针头
zhēntóu
needle



喷雾器
pēnwùqì
spray



散剂
sǎnjì
powder

词汇 cíhuì • vocabulary

铁
tiě
iron

胰岛素
yídǎosù
insulin

一次性的
yíxíngde
disposable

药
yào
medicine

止痛药
zhǐtòngyào
painkiller

钙
gài
calcium

副作用
fùzuòyòng
side-effects

可溶解的
kěróngjiěde
soluble

泻药
xièyào
laxative

镇静剂
zhènjìngjì
sedative

镁
měi
magnesium

有效期限
yǒuxiàoxiàn
expiry date

剂量
jìliàng
dosage

腹泻
fùxiè
diarrhoea

安眠药
ānmiányào
sleeping pill

多种维生素制剂
duōzhǒng
wéishēngsù zhìjì
multivitamins

晕车药
yùncēyào
travel sickness pills

药物治疗
yàowù zhìliáo
medication

润喉片
rùnhóupiàn
throat lozenge

消炎药
xiāoyányào
anti-inflammatory

花店 huādiàn • florist

花
huā
flowers

百合
bǎihé
lily

洋槐
yánghuái
acacia

康乃馨
kāngnǎixīn
carnation

盆栽植物
pénzāi zhíwù
pot plant



剑兰
jiànlán
gladiolus

鸢尾
yuānwěi
iris

雏菊
chújú
daisy

菊花
júhuā
chrysanthemum

满天星
mǎntiānxīng
gypsophila



紫罗兰
zǐluólán
stocks



非洲菊
fēizhōujú
gerbera



叶簇
yècù
foliage



玫瑰
méiguī
rose



小苍兰
xiǎocānglán
freesia

插花 chāhuā • arrangements

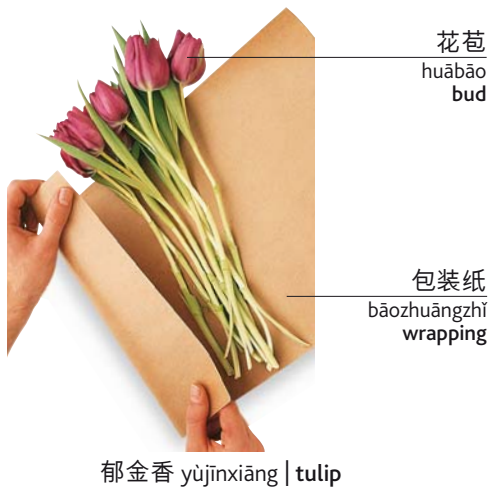
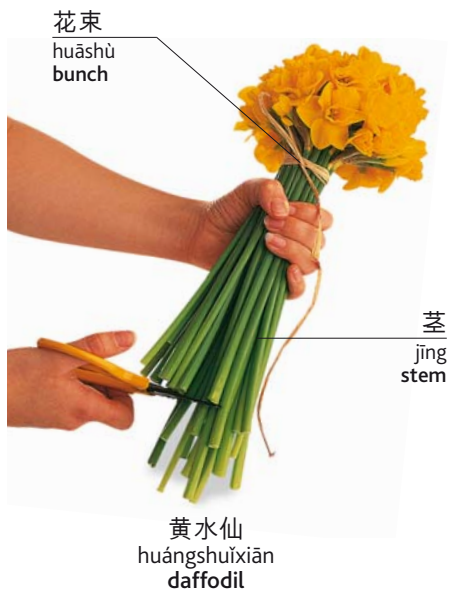
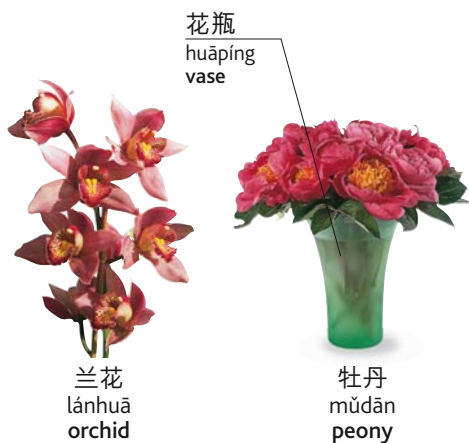

我能附上留言吗？
wǒ néng fùshàng liúyán ma?
Can I attach a message?

能帮我包一下吗？
néng bāng wǒ bāo yíxià ma?
Can I have them wrapped?

能不能将它们送到...？
néngbùnéng jiāng tāmen
sòngdào...?
Can you send them to....?

这些花能开多久？
zhèxiē huā néng kāi duōjiǔ?
How long will these last?

这些花香吗？
zhèxiē huā xiāng ma?
Are they fragrant?

我想买一束...
wǒ xiǎng mǎi yíshù...
Can I have a bunch of... please.

报刊亭 bàokāntíng • newsagent



香烟
xiāngyān
cigarettes

烟盒
yānhé
packet of cigarettes

火柴
huǒchái
matches

彩票, 奖券
cǎipiào, jiǎngquàn
lottery tickets

邮票
yóupiào
stamps



明信片
míngxìnpìàn
postcard



连环画
liánhuánhuà
comic



杂志
zázhì
magazine



报纸
bàozhǐ
newspaper

吸烟 xīyān • smoking



烟草
yāncǎo
tobacco



打火机
dǎhuǒjī
lighter



烟锅
yānguō
bowl

烟嘴
yānzǔi
stem

烟斗
yāndǒu
pipe



雪茄
xuějiā
cigar

糖果店 tángguǒdiàn • confectioner

巧克力盒

qiǎokèlìhé
box of chocolates

零食

língshí
snack bar

薯片

shǔpiàn
crisps

甜食店 tiánshídiàn | sweet shop

词汇 cíhuì • vocabulary

牛奶巧克力
niú'nǎiqiǎokèlì
milk chocolate黑巧克力
hēiqiǎokèlì
plain chocolate白巧克力
báiqiǎokèlì
white chocolate杂拌糖果
zábàntángguǒ
pick and mix焦糖
jiāotáng
caramel巧克力球
qiǎokèlìqiú
truffle饼干
bǐnggān
biscuit硬糖
yìngtáng
boiled sweets

糖果 tángguǒ • confectionery

巧克力
qiǎokèlì
chocolate块状巧克力板
kuàizhuàng qiǎokèlìbǎn
chocolate bar糖果
tángguǒ
sweets棒棒糖
bàngàngtáng
lollipop

太妃糖 tàifēitáng | toffee

奶油杏仁糖
nǎiyóuxíngréntáng | nougat棉花软糖
miánhuāruǎntáng
marshmallow薄荷糖
bòhetáng
mint口香糖
kǒuxiāngtáng
chewing gum软心豆粒糖
ruǎnxīndòulìtáng
jellybean果味橡皮糖
guǒwèixiāngpítáng
fruit gum甘草糖
gāncǎotáng
liquorice

其他店铺 qítā diànpù • other shops



面包店
miànbāodiàn
baker's



糕点店
gāodiǎndiàn
cake shop



肉铺
ròupù
butcher's



水产店
shuǐchǎndiàn
fishmonger's



蔬菜水果店
shūcàishuǐguǒdiàn
greengrocer's



食品杂货店
shípīnzáhùodiàn
grocer's



鞋店
xiédiàn
shoe shop



五金店
wǔjīndiàn
hardware shop



古董店
gǔdǒngdiàn
antiques shop



礼品店
lǐpǐndiàn
gift shop



旅行社
lǚxíngshè
travel agent's



首饰店
shǒushìdiàn
jeweller's



书店
shūdiàn
book shop



音像店
yīnxiàngdiàn
record shop



酒类专卖店
jiǔlèizhuānmàidiàn
off licence



宠物商店
chǒngwùshāngdiàn
pet shop



家具店
jiājùdiàn
furniture shop



时装店
shízhuāngdiàn
boutique



裁缝店
cáifēngdiàn
tailor's



美发厅
měifātīng
hairdresser's

词汇 cíhuì • vocabulary

房地产商
fángdìchǎnshāng
estate agent's

照相器材店
zhàoxiàng qìcáidiàn
camera shop

园艺用品店
yuányì yòngpǐndiàn
garden centre

绿色食品店
lǜsèsìpǐndiàn
health food shop

干洗店
gānxǐdiàn
dry cleaner's

艺术品店
yìshùpǐndiàn
art shop

投币式自动洗衣店
tóubìshì zìdòngxǐyīdiàn
launderette

旧货商店
jiùhuò shāngdiàn
second-hand shop



市场 shìchǎng | market



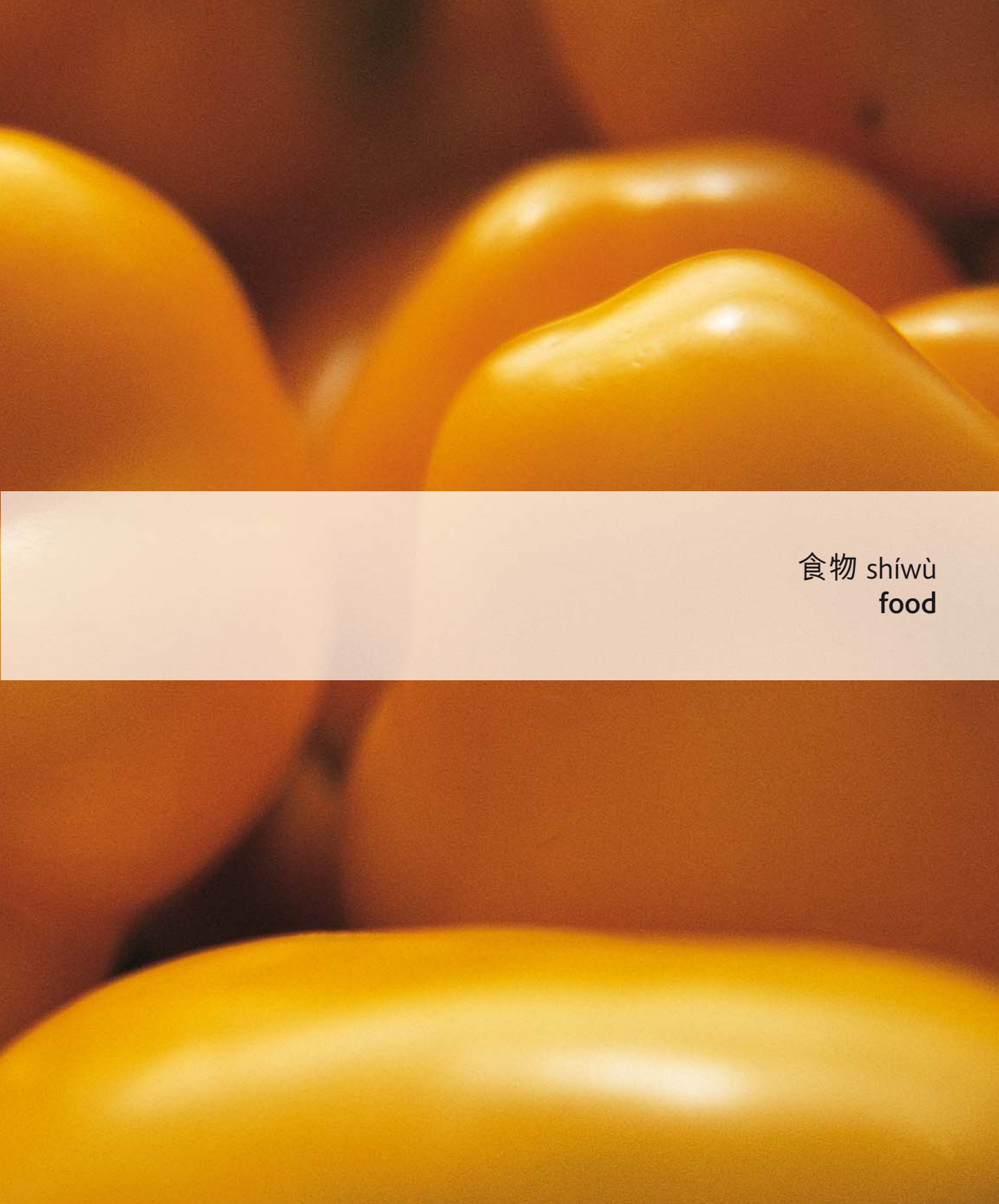

食物 shíwù
food

肉 ròu • meat



词汇 cíhuì • vocabulary

猪肉
zhūròu
pork

野味肉
yěwèiròu
venison

下水
xiàshuǐ
offal

放养的
fàngyǎngde
free range

熟肉
shúròu
cooked meat

牛肉
niúròu
beef

兔肉
tùròu
rabbit

腌制的
yānzhide
cured

有机(饲养)的
yǒuji(siyǎng)de
organic

白肉 (指家禽肉、鱼肉等)
báiròu (zhǐjiāqīnròu, yúròuděng)
white meat

小牛肉
xiǎoniúròu
veal

牛舌
niúshé
tongue

熏制的
xūnzhide
smoked

瘦肉
shòuròu
lean meat

红肉(指牛肉、猪肉和羊肉)
hóngròu (zhǐniúròu, zhūròuhéyáng ròu)
red meat

切块 qiēkuài • cuts

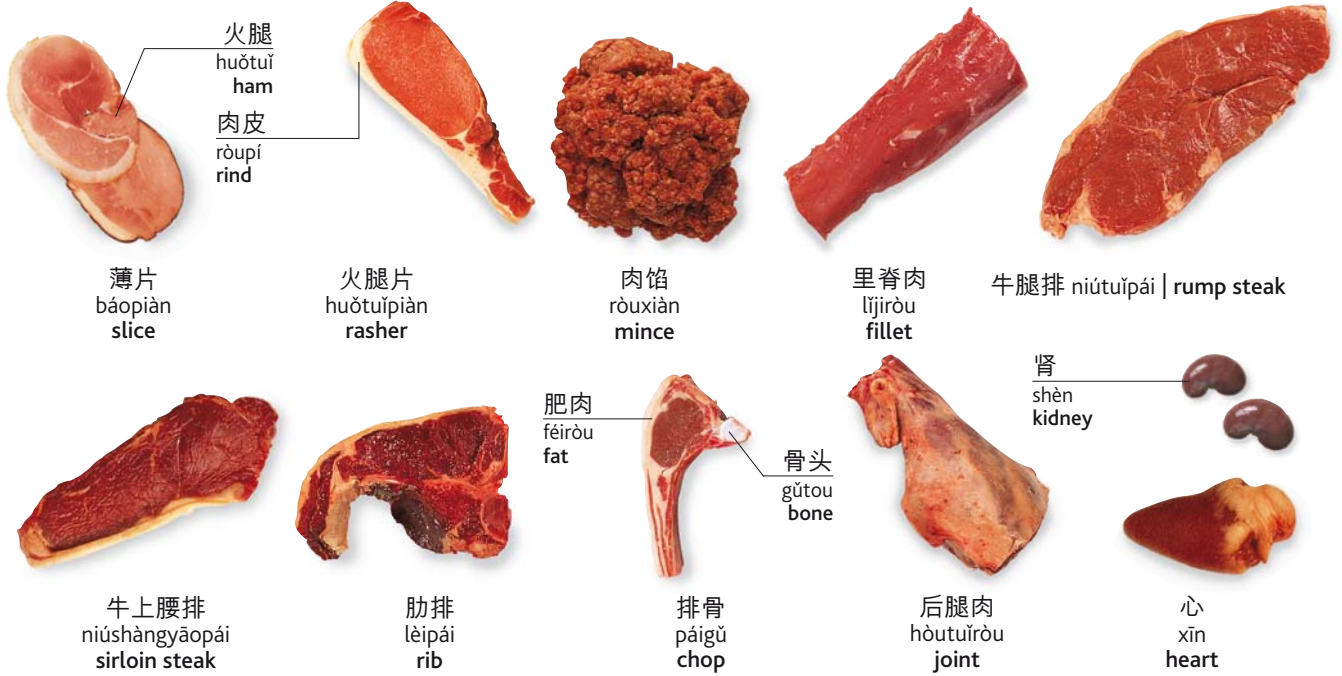

禽肉 qínròu • poultry

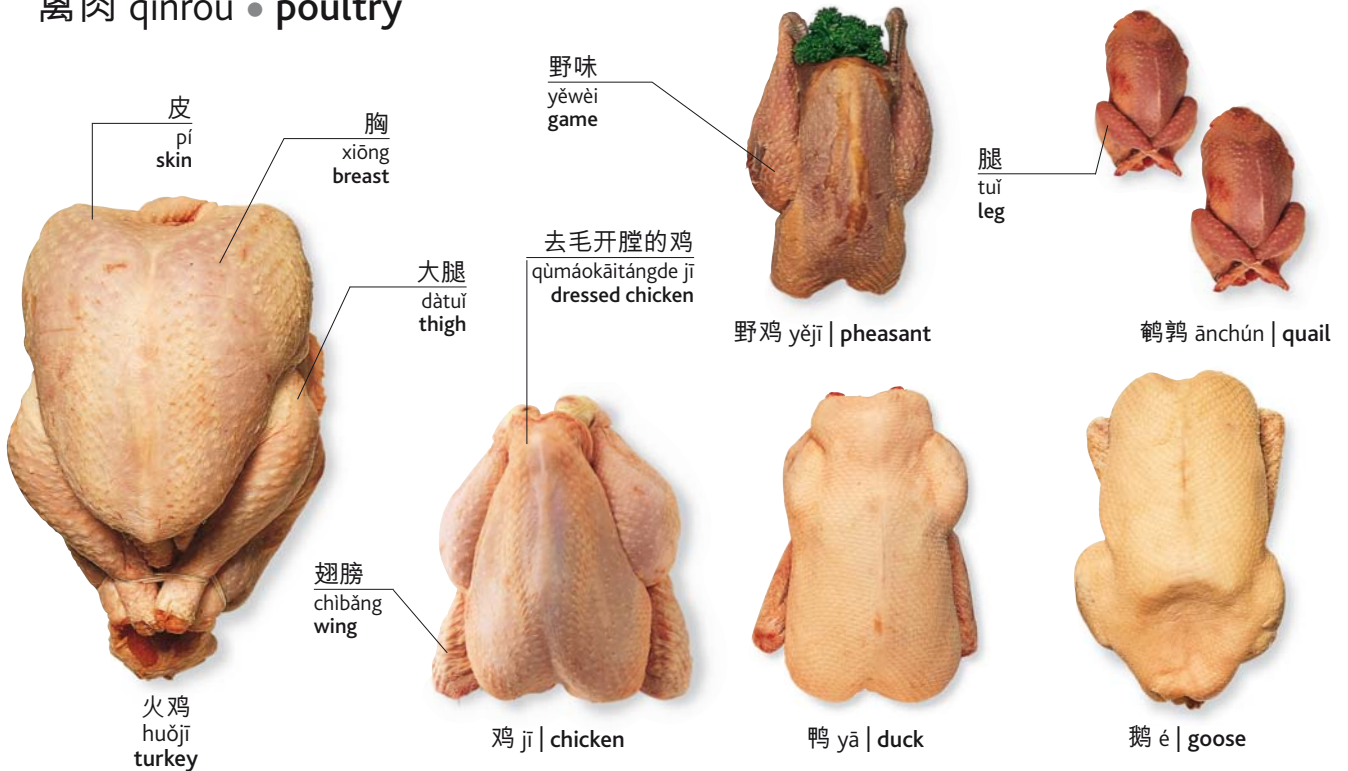

鱼 yú • fish

去皮虾
qùpíxiā
peeled prawns

冰
bīng
ice

羊鱼
yángyú
red mullet

大比目鱼片
dàbǐmùyúpiàn
halibut fillets

虹鳟鱼
hóngzūnyú
rainbow trout

鳐鱼翅
yáoyúchì
skate wings



水产店
shuǐchǎndiàn
fishmonger's



鮫鳐鱼
ānkāngyú
monkfish



鲭鱼
qīngyú
mackerel



鳟鱼
zūnyú
trout



剑鱼
jiànyú
swordfish



鲳鱼
tǎiyú
Dover sole



黄盖鲽
huánggàidié
lemon sole



黑线鳕
hēixiànxuē
haddock



沙丁鱼
shādīngyú
sardine



鳐鱼
yáoyú
skate



牙鳕
yáxuē
whiting



海鲈
hǎilú
sea bass



鲑鱼
guīyú | salmon



鳕鱼
xuēyú
cod



鲷鱼
diāoyú
sea bream



金枪鱼
jīnqiāngyú
tuna

海鲜 hǎixiān • seafood

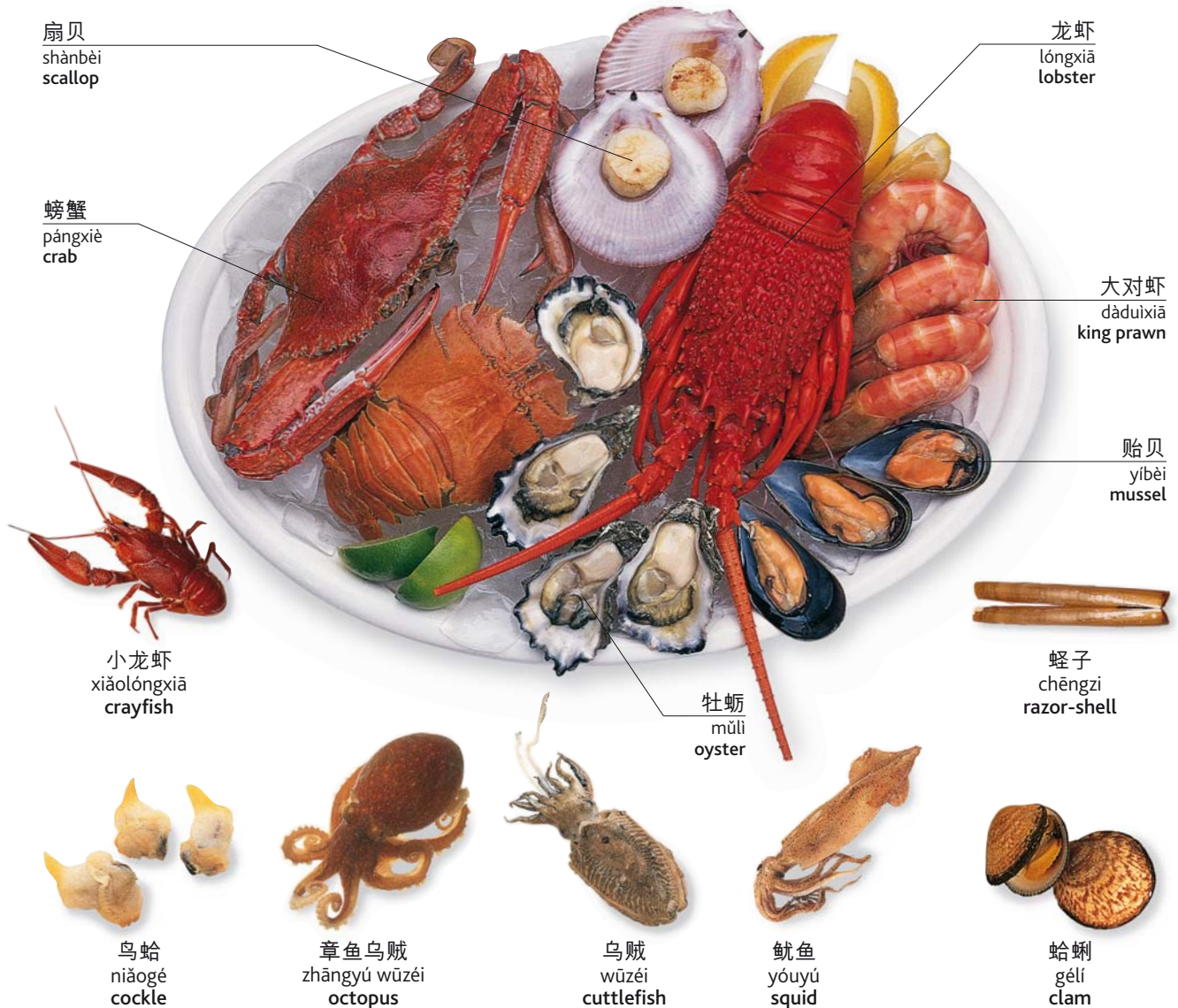

词汇 cíhuì • vocabulary

冷冻的
lěngdòngde
frozen

盐渍的
yánzide
salted

熏制的
xūnzhide
smoked

去鳞的
qùlínde
descaled

去骨鱼片
qùgǔyúpiàn
fillet

腰肉
yāoròu
loin

尾部
wěibù
tail

骨头
gūtou
bone

鳞片
línpiàn
scale

新鲜
xīnxiān
fresh

处理干净的
chǔlǐgān
jìngde
cleaned

去皮的
qùpíde
skinned

去骨的
qùgǔde
boned

切片的
qiēpiànde
filleted

鱼片
yúpiàn
steak

能帮我把它收拾干净吗?
néng bāng wǒ bǎ tā shōushi gānjìng ma?
Will you clean it for me?

蔬菜1 shūcài yī • vegetables 1

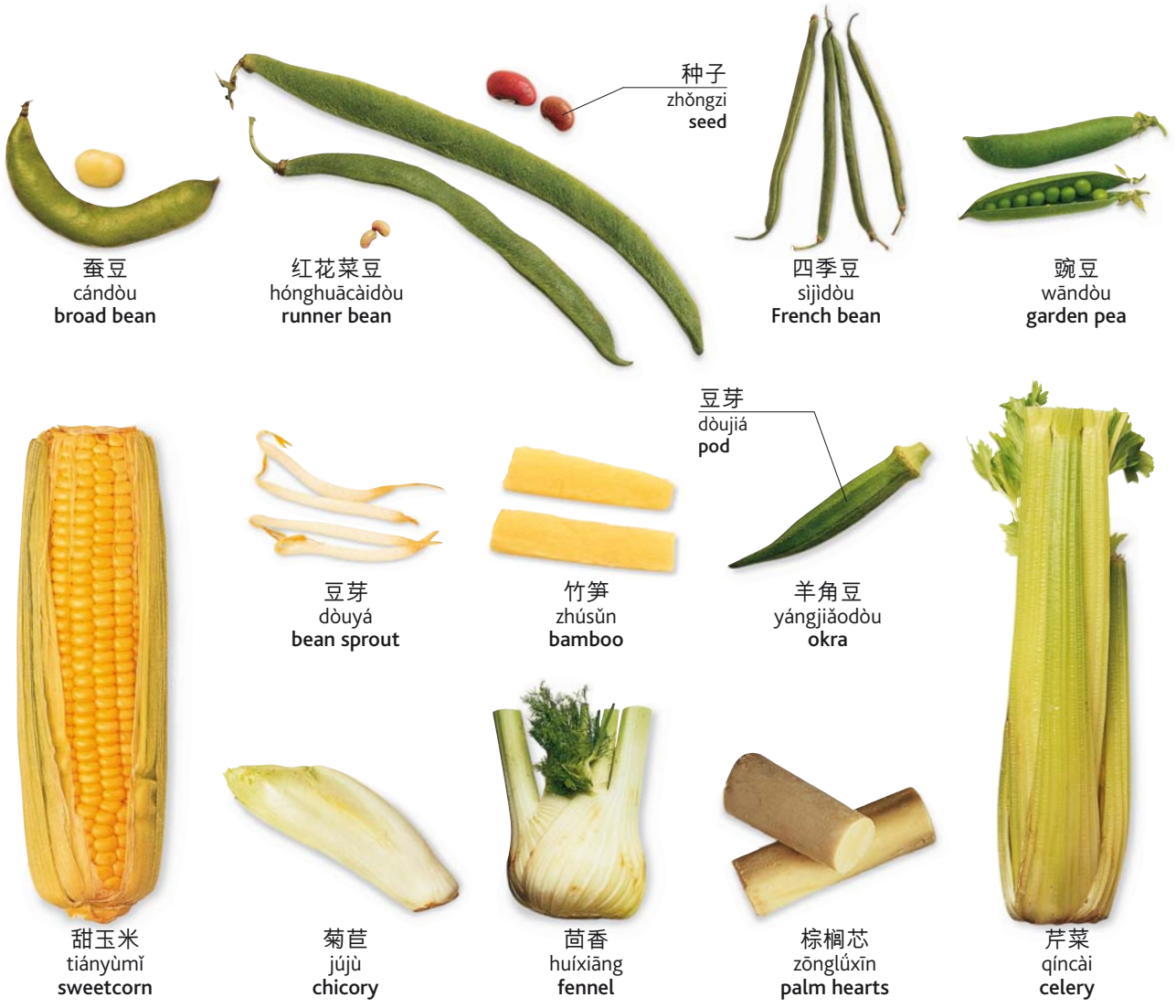

词汇 cíhuì • vocabulary

叶 yè
leaf

小花 xiǎohuā
florete

尖 jiān
tip

有机(栽培)的 yǒuji(zāipéi)de
organic

这儿卖有机蔬菜吗?
zhè'er mài yǒujīshūcài ma?
Do you sell organic vegetables?

菜梗 cài gěng
stalk

果仁 guǒrén
kernel

芯 xīn
heart

塑料袋 sùliàodài
plastic bag

这些是当地产的吗?
zhèxiē shì dāngdìchǎnde ma?
Are these grown locally?



芝麻菜
zhīmá cài
rocket



豆瓣菜
dòubàn cài
watercress



红球菊苣
hóngqiú jújù
radicchio



抱子甘蓝
bào zǐ gān lán
Brussels sprouts



甜叶菜
tiányè cài
Swiss chard



羽衣甘蓝
yǔyī gān lán
kale



酸模
suān mó
sorrel



苦苣
kǔ jù
endive



蒲公英
púgōngyīng
dandelion



菠菜
bō cài
spinach



球茎甘蓝
qiújīng gān lán
kohlrabi



油菜
yóu cài
pak-choi



莴苣
wō jù
lettuce



西兰花
xī lán huā
broccoli



卷心菜
juǎn xīn cài
cabbage



嫩圆白菜
nèn yuán bái cài
spring greens

蔬菜2 shūcài'èr • vegetables 2



词汇 cíhuì • vocabulary

樱桃番茄
yīngtáofānqié
cherry tomato

块根芹
kuàigēnqín
celeriac

冷冻的
lěngdòngde
frozen

苦
kǔ
bitter

请给我一公斤马铃薯。
qǐng gěi wǒ yì gōngjīn mǎlǐngshǔ.
Can I have one kilo of potatoes
please?

胡萝卜
húluóbo
carrot

芋头
yùtóu
taro root

生
shēng
raw

硬
yìng
firm

每公斤多少钱？
měi gōngjīn duōshǎo qián?
What's the price per kilo?

面包果
miànbāoguǒ
breadfruit

木薯
mùshǔ
cassava

辣
là
hot (spicy)

果肉
guǒròu
flesh

那些叫什么？
nàxiē jiào shéname?
What are those called?

嫩马铃薯
nènmǎlǐngshǔ
new potato

荸荠
bíqí
water chestnut

甜
tián
sweet

根
gēn
root



红薯
hóngshǔ
sweet potato



山药
shānyào
yam



甜菜
tiāncài
beetroot



芜菁甘蓝
wújīngānlán
swede



菊芋
júyù
Jerusalem artichoke



辣根菜
làgēncài
horseradish



欧洲防风根
ōuzhōufāngfēnggēn
parsnip



姜
jiāng
ginger



茄子
qiézi
aubergine



番茄
fānqié
tomato



葱
cōng
spring onion

韭葱
jiǔcōng
leek



葱头
cōngtóu
shallot



大蒜
dàsuàn
garlic

蒜瓣儿
suàn bàn' er
clove



蘑菇
mógū
mushroom

块菌
kuàijūn
truffle

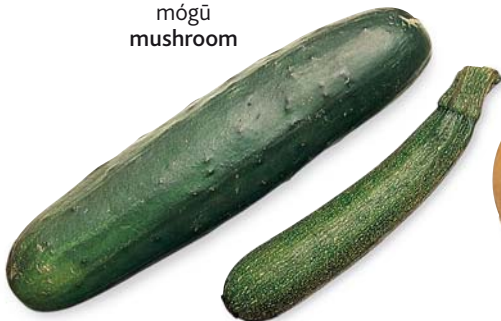

黄瓜
huángguā
cucumber

密生西葫芦
mìshēngxīhúlu
courgette



冬南瓜
dōngnánguā
butternut squash



橡果
xiàngguǒ
acorn squash



南瓜
nánguā
pumpkin

水果1 shuǐguǒ yī • fruit 1

柑橘类水果 gānjú lèishuǐguǒ • citrus fruit



橘子
júzi
orange



细皮小柑橘
xìpíxiǎogānjú
clementine



牙买加丑橘
yámǎijiǎchǒujú
ugli fruit

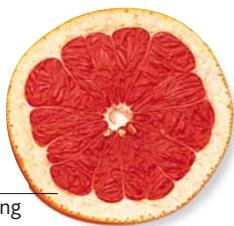

海绵层
hǎimiáncéng
pith

葡萄柚
pútáoyòu
grapefruit



橘瓣儿
júbànr
tangerine

橘瓣儿
júbànr
segment



无核蜜橘
wúhémìjú
satsuma



酸橙
suānchéng
lime

外皮
wàipí
zest



柠檬
níngméng
lemon



金橘
jīnjú
kumquat

有核水果 yǒuhéshuǐguǒ • stoned fruit



桃
táo
peach



油桃
yóutáo
nectarine



杏
xìng
apricot



李子
lǐzi
plum



樱桃
yīngtáo
cherry

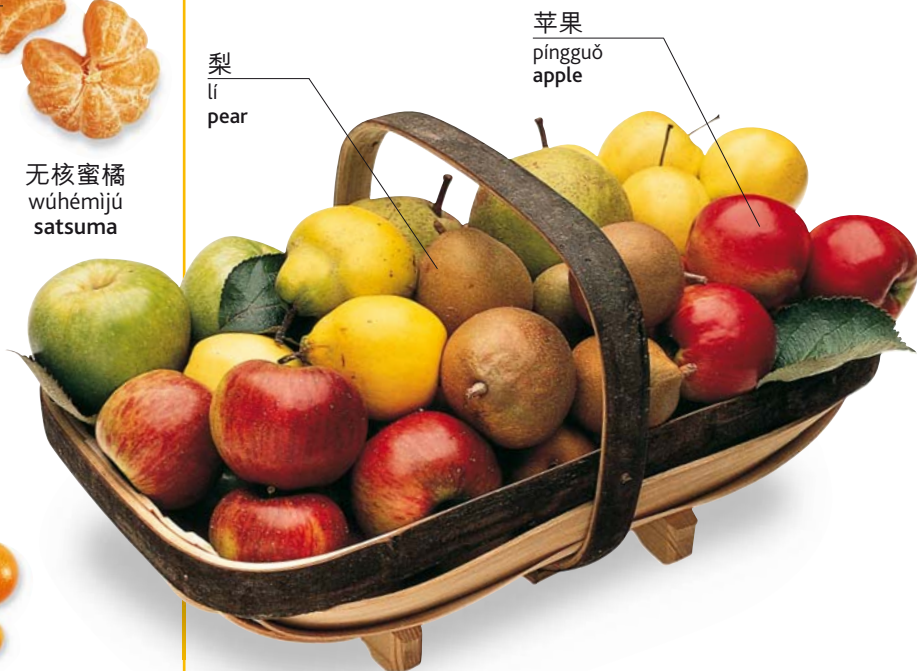

梨
lí
pear

苹果
píngguǒ
apple

果篮 guǒlán | basket of fruit

浆果和甜瓜 jiāngguǒ hé tiánguā • berries and melons



草莓
cǎoméi
strawberry



覆盆子
fùpénzi
raspberry



甜瓜
tiánguā
melon



葡萄
pútáo
grapes



黑莓
hēiméi
blackberry



红醋栗
hóngcùlì
redcurrant



黑醋栗
hēicùlì
blackcurrant



蔓越橘
mànyuèjú
cranberry

瓜皮
guāpí
rind

瓜籽
guāzǐ

瓜瓤
guāráng
flesh



蓝莓
lánméi
blueberry



白醋栗
báicùlì
white currant

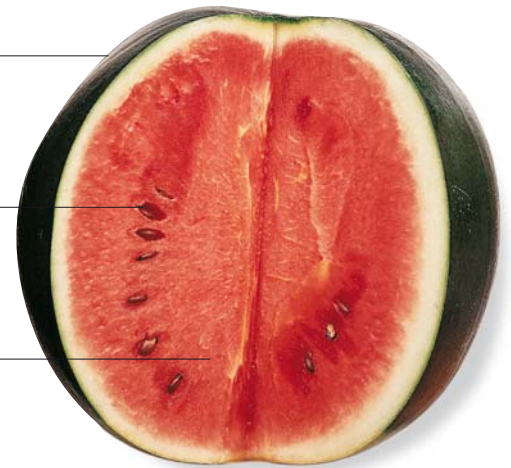

西瓜
xīguā
watermelon



罗甘莓
luógānméi
loganberry



醋栗
cùlì
gooseberry

词汇 cíhuì • vocabulary

大黄
dàihuáng
rhubarb

酸
suān
sour

脆
cuì
crisp

汁液
zhīyè
juice

它们熟吗？
tāmen shú ma?
Are they ripe?

纤维
xiānwéi
fibre

新鲜
xīnxiān
fresh

烂
làn
rotten

核
hé
core

我可以尝一个吗？
wǒ kěyǐ cháng yigè ma?
Can I try one?

甜
tián
sweet

多汁
duōzhī
juicy

果肉
guǒròu
pulp

无核
wúhé
seedless

它们能放多久？
tāmen néng fàng duōjiǔ?
How long will they keep?

水果2 shuǐguǒ 2 • fruit 2

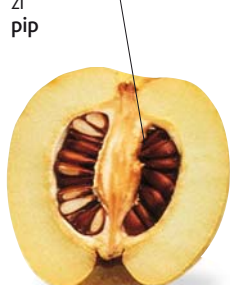

榲桲
yùnbó
quince



西番莲果
xīfānliánguǒ
passion fruit

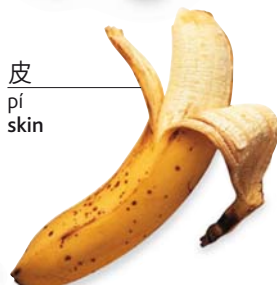

香蕉
xiāngjiāo
banana



番石榴
fānshíliú
guava



石榴
shíliú
pomegranate



柿子
shìzi
persimmon



费约果
fèiyuēguǒ
feijoa



仙人掌果
xiānrénzhǎngguǒ
prickly pear



杨桃
yángtáo
starfruit



山竹果
shānzhúguǒ
mangosteen

坚果和干果 jiānguǒ hé gānguǒ • nuts and dried fruit



松子
sōngzǐ
pine nut



开心果
kāixīnguǒ
pistachio



腰果
yāoguǒ
cashewnut



花生
huāshēng
peanut



榛子
zhēnzi
hazelnut



巴西果
bāxīguǒ
brazil nut



美洲山核桃
měizhōushānhétào
pecan



杏仁
xīngrén
almond



核桃
hétào
walnut



栗子
lizi
chestnut



澳洲坚果
àozhōujiānguǒ
macadamia



无花果
wúhuāguǒ
fig



椰枣
yēzǎo
date



梅干
méigān
prune

壳
ké
shell



无核葡萄干
wúhépútáogān
sultana



葡萄干
pútáogān
raisin



无核小葡萄干
wúhéxiǎopútáogān
currant

果肉
guǒròu
flesh

椰子
yēzi
coconut



词汇 cíhuì • vocabulary

未熟的
wèishúde
green

硬
yìng
hard

果仁
guǒrén
kernel

盐渍的
yánzide
salted

烘烤的
hōngkǎode
roasted

去壳的
qùkéde
shelled

蜜饯
mìjiàn
candied fruit

成熟的
chéngshúde
ripe

软
ruǎn
soft

脱水的
tuōshuide
desiccated

生
shēng
raw

应季的
yìngjide
seasonal

完整
wánzhěng
whole

热带水果
rèdàishuǐguǒ
tropical fruit

谷物及豆类 gǔwùjídòulèi • grains and pulses

谷物 gǔwù • grains



小麦
xiǎomài
wheat



燕麦
yànmai
oats



大麦
dàmai
barley



小米
xiǎomǐ
millet



玉米
yùmǐ
corn



奎奴亚藜
kuínúyálí
quinoa

词汇 cíhuì • vocabulary

种子
zhǒngzi
seed

香
xiāng
fragranced

易烹调的
yìpēngtiáode
easy cook

外壳
wàiké
husk

谷类食品
gǔlèishípǐn
cereal

长粒
chánglǐ
long-grain

谷粒
gǔlǐ
kernel

整粒
zhěnglǐ
wholegrain

圆粒
yuánlǐ
short-grain

干燥
gānzào
dry

浸泡
jìnpào
soak (v)

新鲜
xīnxiān
fresh

米 mǐ • rice



白米
báimǐ
white rice



糙米
cāomǐ
brown rice



菰米
gūmǐ
wild rice



布丁米
bùdīngmǐ
pudding rice

加工过的谷物 jiāgōngguòde gǔwù • processed grains



蒸粗麦粉
zhēngcūmàifěn
couscous



碎粒小麦
suìlǐxiǎomài
cracked wheat



粗粒小麦粉
cūlǐxiǎomàifěn
semolina



麦麸
màifū
bran

豆类 dòulèi • beans and peas



棉豆
miándòu
butter beans



菜豆
càidòu
haricot beans



红芸豆
hóngyúndòu
red kidney beans



赤豆
chìdòu
aduki beans



蚕豆
cándòu
broad beans



大豆
dàdòu
soya beans



黑眼豆
hēiyǎndòu
black-eyed beans



斑豆
bāndòu
pinto beans



绿豆
lǜdòu
mung beans



小(粒)菜豆
xiǎo(li)càidòu
flageolet beans



褐色小扁豆
hèsèxiǎobiǎndòu
brown lentils



红豆
hóngdòu
red lentils



青豆
qīngdòu
green peas



鹰嘴豆
yīngzuǐdòu
chick peas



半粒豆
bànlìdòu
split peas

种子 zhǒngzi • seeds



南瓜籽
nánguāzǐ
pumpkin seed



芥菜籽
jiècǎizǐ
mustard seed



葛缕子籽
gélǚzǐ
caraway



芝麻籽
zhīmázi
sesame seed



向日葵籽
xiàngrìkuǐzi
sunflower seed

香草和香辛料 xiāngcǎo hé xiāngxīnliào • herbs and spices

香辛料 xiāngxīnliào • spices



香子兰 xiāngzǐlán | vanilla



肉豆蔻 ròudòukòu
nutmeg



肉豆蔻衣 ròudòukòuyī
mace



姜黄根 jiānghuángēn
turmeric



枯茗, 小茴香 kūmíng, xiǎohuixiāng
cumin



香料包 xiāngliàobāo
bouquet garni



多香果 duōxiāngguǒ
allspice



胡椒粒 hújiāoli
peppercorn



葫芦巴 húlúba
fenugreek



辣椒末 làjiāomò
chilli

颗粒状
kēlìzhuàng
whole

压碎的
yāsuide
crushed



藏红花 zànghónghuā
saffron



小豆蔻 xiǎodòukòu
cardamom



咖喱粉 gālífěn
curry powder



磨碎的
mósuide
ground



辣椒粉 làjiāofěn
paprika

片状
piànzuàng
flakes



大蒜 dàsuàn
garlic

香草 xiāngcǎo • herbs

桂皮
guìpí
sticks



肉桂
ròuguì
cinnamon



柠檬草
níngméngcǎo
lemon grass



丁香
dīngxiāng
cloves



八角, 大料
bājiǎo, dàliào
star anise



姜
jiāng
ginger



茴香籽
huíxiāngzǐ
fennel seeds



茴香
huíxiāng
fennel



细香葱
xìxiāngcōng
chives



龙蒿
lónghāo
tarragon



牛至
niúzhì
oregano



薄荷
bòhe
mint



墨角兰
mòjiǎolán
marjoram



香菜
xiāngcài
coriander



月桂叶
yuèguìyè
bay leaf



百里香
bǎilǐxiāng
thyme



罗勒
luólè
basil



莳萝
shíluó
dill



欧芹
ōuqín
parsley



鼠尾草
shǔwěicǎo
sage



迷迭香
mídiéxiāng
rosemary

瓶装食品 píngzhuāngshípǐn • bottled foods



甜酱 tiánjiàng • sweet spreads



调味品 tiáowèipǐn • condiments and spreads



词汇 cíhuì • vocabulary

玉米油 yùmǐyóu corn oil

菜籽油 càiǐyóu rapeseed oil

花生油 huāshēngyóu groundnut oil

冷榨油 lěngzhà yóu cold-pressed oil

植物油 zhíwùyóu vegetable oil

乳制品 rǔzhìpǐn • dairy produce

奶酪 nǎilào • cheese

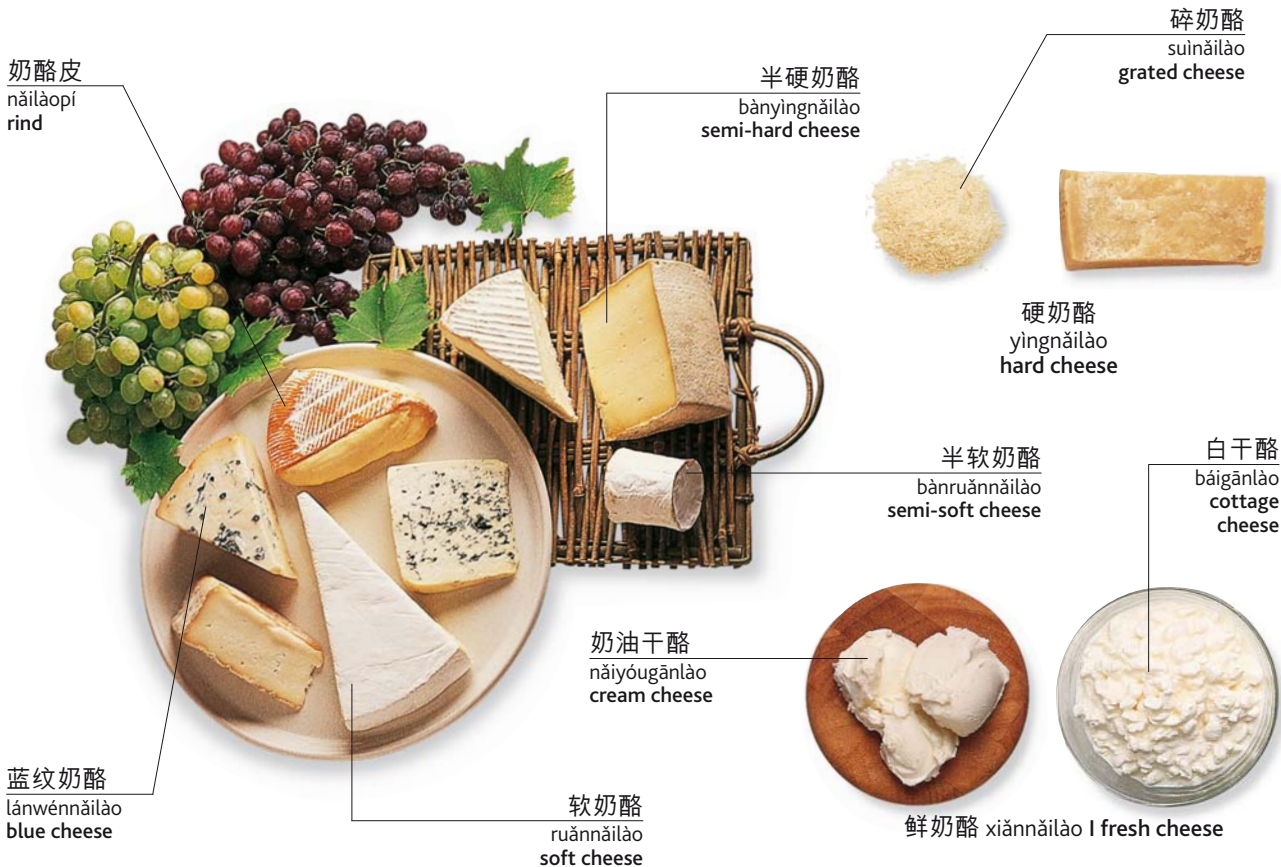

奶 nǎi • milk





黄油
huángyóu
butter



人造黄油
rénzàohuángyóu
margarine



奶油
nǎiyóu
cream



脱脂奶油
tuōzhīnǎiyóu
single cream



高脂肪奶油
gāozhīfāngnǎiyóu
double cream



搅奶油
guǎnnǎiyóu
whipped cream



酸奶油
suānnǎiyóu
sour cream



酸奶
suānnǎi
yoghurt



冰激凌
bīngjīlíng
ice-cream

蛋 dàn • eggs

蛋黄
dànhuáng
yolk

蛋白
dànbái
egg white

蛋壳
dànké
shell

蛋杯
dànbēi
egg cup

煮鸡蛋 zhǔjīdàn | boiled egg

鹅蛋
édàn
goose egg

鸡蛋
jīdàn
hen's egg

鸭蛋
yādàn
duck egg

鹌鹑蛋
ānchúndàn
quail egg

词汇 cíhuì • vocabulary

已经过巴氏消毒的
yǐ jīngguò bāshìxiāodúde
pasteurized

奶昔
nǎixī
milkshake

盐渍的
yáncide
salted

绵羊奶
miányángnǎi
sheep's milk

乳糖
rǔtáng
lactose

均质
jūnzhì
homogenised

未经过巴氏消毒的
wèi jīngguò bāshìxiāodúde
unpasteurized

冻酸奶
dòngsuānnǎi
frozen yoghurt

无盐的
wúyánde
unsalted

酪乳
lǎorǔ
buttermilk

不含脂肪的
bùhánzhīfāngde
fat free

奶粉
nǎifěn
powdered milk

面包和面粉 miànbāo hé miànfěn • breads and flours

切片面包
qiēpiànmiànbāo
sliced bread

罌粟籽
yīngsùzǐ
poppy seeds

黑面包
hēimiànbāo
rye bread

棍子面包
gùnzi miànbāo
baguette



面包店 miànbāodiàn | bakery

制作面包 zhìzuò miànbāo • making bread



精白面粉
jīngbáimiànfěn
white flour



黑麦面粉
hēimàimiànfěn
brown flour



全麦面粉
quánmàimiànfěn
wholemeal flour



酵母
jiàomǔ
yeast



筛撒 shāisǎ | sift (v)



搅拌 jiǎobàn | mix (v)

生面团
shēng
miàntuán
dough



和面 huómian | knead (v)



烘制 hōngzhì | bake (v)



面包皮
miànbāopí
crust

白面包
báimiànbāo
white bread



面包块
miànbāokuài
loaf

黑面包
hēimiànbāo
brown bread



全麦面包
quánmàimiànbāo
wholemeal bread

切片
qiēpiàn
slice

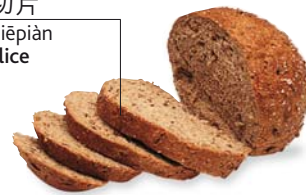

麸皮面包
fūpímiànbāo
granary bread



玉米面包
yùmǐmiànbāo
corn bread



苏打面包
sūdàmiànbāo
soda bread



酸面包
suānmiànbāo
sourdough bread



薄干脆饼
báogāncuībǐng
flatbread



硬面包圈，百吉饼
yìngmiànbāoquān, bǎijībǐng
bagel



软面包片
ruǎnmiànbāopiàn | bap



小面包
xiǎomiànbāo | roll



葡萄干面包
pútáogānmiànbāo
fruit bread



撒籽面包
sǎzǐmiànbāo
seeded bread



印度式面包
yìndùshìmiànbāo
naan bread



皮塔饼
pítǎbǐng
pitta bread



薄脆饼干
báocuībǐnggān
crispbread

词汇 cíhuì • vocabulary

高筋面粉
gāojīnmiànfěn
strong flour

发起
fāqǐ
rise (v)

发酵
fājiào
prove (v)

面包屑
miànbāoxiè
breadcrumbs

切片器
qiēpiànqì
slicer

自发粉
zìfāfěn
self-raising flour

中筋面粉
zhōngjīnmiànfěn
plain flour

浇糖
jiāotáng
glaze (v)

细长形面包
xìchángxíngmiànbāo
flute

面包师
miànbāoshī
baker

糕点 gāodiǎn • cakes and desserts

长条奶油夹
心点心
chángtiáo
nǎiyóu jiāxīn
diǎnxīn
éclair

奶油
nǎiyóu
cream

夹心
jiāxīn
filling

油酥点心
yóusūdiǎnxīn
choux pastry

奶油泡芙
nǎiyóupàofú
puff pastry

夹心酥
jiāxīnsū
filo pastry



水果蛋糕
shuǐguǒ dàngāo
fruit cake

水果馅饼
shuǐguǒ xiànbǐng
fruit tart

蛋白甜饼
dànbái tiánbǐng
meringue

外覆巧克力
wàifù qiǎokèlì
chocolate coated

松饼
sōngbǐng
muffin

松糕
sōnggāo
sponge cake



蛋糕 dàngāo | cakes

词汇 cíhuì • vocabulary

奶油蛋糕
nǎiyóu dàngāo
crème pâtissière

小圆蛋糕
xiǎoyuán dàngāo
bun

面团
miàntuán
pastry

米饭布丁
mǐfàn bùdīng
rice pudding

我可以吃一片吗？
wǒ kěyǐ chī yīpiàn ma?
May I have a slice please?

巧克力蛋糕
qiǎokèlì dàngāo
chocolate cake

蛋奶糕
dànnǎigāo
custard

切片
qiēpiàn
slice

庆祝会
qìngzhùhuì
celebration

巧克力脆片
qiǎokèlì cuipiàn
chocolate chip



指形饼干
zhǐxíng bǐnggān
sponge fingers

果仁巧克力脆饼
guǒrén qiǎokèlì
cuībǐng
florentine



蜜饯布丁
mìjiàn bùdǐng
trifle

饼干 bǐnggān | biscuits



奶油冻，慕思
nǎiyóudòng, mùsī
mousse



果汁冰糕
guǒzhī bīnggāo
sorbet



奶油馅饼
nǎiyóu xiànbǐng
cream pie



焦糖蛋奶
jiāotáng dànǎi
crème caramel

庆祝蛋糕 qìngzhù dàngāo • celebration cakes

顶层
dǐngcéng
top tier

底层
dǐcéng
bottom tier

杏仁糊
xìngrénhú
marzipan

缎带
duàndài
ribbon

糖霜
tángshuāng
icing



婚礼蛋糕 hūnlǐ dàngāo | wedding cake

装饰
zhuāngshì
decoration

生日蜡烛
shēngrì làzhú
birthday candles

吹熄
chuīxī
blow out (v)



生日蛋糕 shēngrì dàngāo | birthday cake

熟食店 shúshídiàn • delicatessen

辣香肠
làxiāngcháng
spicy sausage

油
yóu
oil



萨拉米香肠
sālāmǐ
xiāngcháng
salami

醋
cù
vinegar

生肉
shēngròu
uncooked meat

柜台
guìtái
counter

意大利辣香肠
yìdàlì
xiāngcháng
pepperoni

果酱饼
guǒjiāngbǐng
flan



肉酱
ròujiāng
pâté



莫泽雷勒干酪
mòzéléilè gānlào
mozzarella



布里干酪
bùlǐ gānlào
brie



山羊奶酪
shānyáng nǎilào
goat's cheese



切达干酪
qiēdá gānlào
cheddar



帕尔马干酪
pà'ěrmǎ gānlào
parmesan



卡门贝干酪
kǎménbèi gānlào
camembert

外皮
wàipí
rind



伊丹奶酪
yīdānnǎilào
edam



蒙切各干酪
méngqiēgè gānlào
manchego



西式馅饼, 派
xīshì xiànbǐng, pài
pies

小圆面包
xiǎoyuán miànbāo
bread roll

熟肉
shúròu
cooked meat

绿橄榄
lǜgǎnlǎn
green olive

火腿
huǒtuǐ
ham



黑橄榄
hēigǎnlǎn
black olive

辣椒
làjiāo
chili

酱
jiàng
sauce

三明治柜台 sānmíngzhì guìtái | sandwich counter



熏鱼
xūnyú
smoked fish



马槟榔
mǎbīngláng
capers



蒜味腊肠
suànwèilācháng
chorizo

意大利熏火腿
yìdàlì xūnhuǒtuǐ
prosciutto



填馅橄榄
tiánxiàn gǎnlǎn
stuffed olive

词汇 cíhuì • vocabulary

油渍
yóuzi
in oil

醋渍的
cùzide
marinated

熏制的
xūnzhide
smoked

卤制
lǔzhi
in brine

盐渍的
yánzide
salted

风干的
fēnggānde
cured

请拿一个号。
qǐng ná yīgè hào.
Take a number please.

我能尝尝吗？
wǒ néng chángcháng ma?
Can I try some of that please?

请来6片。
qǐng lái liù piàn.
May I have six slices of that please?

饮料 yǐnliào • drinks

水 shuǐ • water



热饮 rèyǐn • hot drinks



软(不含酒精的)饮料 ruǎn (bùhán jiǔjīngde) yǐnliào • soft drinks



含酒精饮料 hán jiǔjīng yǐnliào • alcoholic drinks



杜松子酒
dùsōngzǐjiǔ | gin



啤酒
píjiǔ
beer

罐
guàn
can



苹果酒
píngguǒjiǔ
cider



苦啤酒
kǔpíjiǔ
bitter



浓烈黑啤酒
nóngliè hēipíjiǔ
stout



伏特加酒
fú tè jiā jiǔ | vodka



威士忌 wēishìji | whisky



朗姆酒
lǎngmǔjiǔ
rum



白兰地
báilándì
brandy



波尔图葡萄酒
bōěrtú pútáojiǔ
port



雪利酒
xuélìjiǔ
sherry

无糖份的
wútángfēnde
dry



堪培利酒
kānpéilìjiǔ
campari

玫瑰红(葡萄酒)
méiguīhóng
(pútáojiǔ)
rosé (wine)

白(葡萄酒)
bái (pútáojiǔ)
white (wine)

红(葡萄酒)
hóng
(pútáojiǔ)
red (wine)



利口酒
lìkǒujiǔ
liqueur



龙舌兰酒
lóngshélánjiǔ
tequila



香槟酒
xiāngbīnjiǔ
champagne



葡萄酒 pútáojiǔ | wine





外出就餐 wàichū jiùcān
eating out

咖啡馆 kāfēiguǎn • café



菜单
càidān
menu

遮阳篷
zhēyángpéng
awning

路边咖啡座 lùbiān kāfēizuò | pavement café



遮阳伞
zhēyángsǎn
umbrella

露天咖啡座
lùtiān kāfēizuò
terrace café

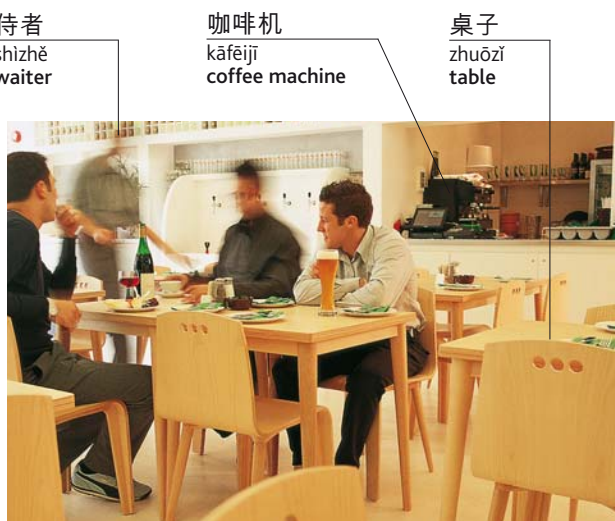

侍者
shìzhě
waiter

咖啡机
kāfēijī
coffee machine

桌子
zhuōzi
table

快餐店 kuàicāndiàn | snack bar

咖啡 kāfēi • coffee

牛奶咖啡
niú'nǎi kāfēi
white coffee

黑咖啡
hēikāfēi
black coffee

可可粉
kěkěfěn
cocoa powder

泡沫
pàomò
froth



过滤式咖啡
guòlǜshì kāfēi
filter coffee



意式浓缩咖啡
yìshìnóngsuō kāfēi
espresso



卡布奇诺咖啡
kǎbùqínò kāfēi
cappuccino



冰咖啡
bīngkāfēi
iced coffee

茶 chá • tea

草药茶
cǎoyàochá
herbal tea



奶茶
nǎichá
tea with milk

红茶
hóngchá
black tea



菊花茶
júhuāchá
camomile tea



柠檬茶
níngméngchá
tea with lemon



绿茶
lǜchá
green tea



薄荷茶
bòhechá
mint tea



冰茶
bīngchá
iced tea

果汁和奶昔 guǒzhī hé nǎixī • juices and milkshakes



橘子汁
júzǐzhī
orange juice



苹果汁
píngguǒzhī
apple juice



菠萝汁
bōluózhī
pineapple juice



番茄汁
fānqiézhī
tomato juice

巧克力奶昔
qiǎokèlì nǎixī
chocolate milkshake

草莓奶昔
cǎoméi nǎixī
strawberry milkshake

咖啡奶昔
kāfēi nǎixī
coffee milkshake



食物 shíwù • food

黑面包
hēimiànbāo
brown bread

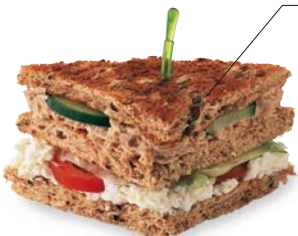

烤三明治
kāosānmíngzhì
toasted sandwich



沙拉
shālā
salad



一勺量
yīsháo liàng
scoop

冰激凌
bīngjīlíng
ice cream



油酥点心
yóusūdiǎnxīn
pastry

酒吧 jiǔbā • bar



玻璃杯
bōlibēi
glasses

量杯
liángbēi
optic

收款机
shōukuǎnjī
till

酒保
jiǔbǎo
bartender

啤酒龙头
pījiǔ lóngtóu
beer tap

咖啡机
kāfēijī
coffee machine

冰桶
bīngtǒng
ice bucket

酒吧椅
jiǔbāyǐ
bar stool

烟灰缸
yānhuīgāng
ashtray

杯垫
bēidiàn
coaster

吧台
bātái
bar counter

开瓶器
kāipíngqì
bottle opener



拔塞钻 bāsāizhuàn | corkscrew

摇杆
yáogǎn
lever

夹钳
jiáqián
tongs

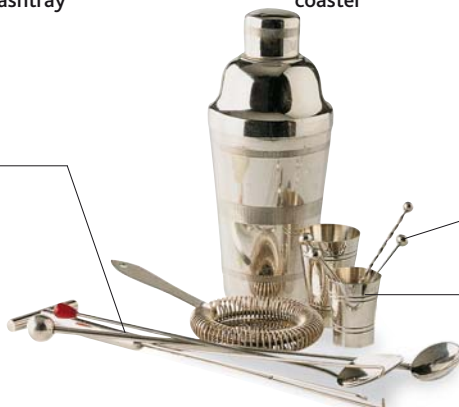

鸡尾酒调制器 jīwěijiǔ tiáozhìqì
cocktail shaker

搅拌棒
jiǎobànbàng
stirrer

量杯
liángbēi
measure



奎宁杜松子酒
kuíning dùsōngzǐjiǔ
gin and tonic

水罐
shuǐguàn
pitcher



加水威士忌
jiāshuǐ wēishìjī
scotch and water



加可乐朗姆酒
jiākèlè lǎngmǔjiǔ
rum and coke

冰块
bīngkuài
ice cube



加橙汁伏特加酒
jiāchéngzhī fú tèjiājiǔ
vodka and orange



马提尼酒
mǎtíniǐjiǔ
martini



鸡尾酒
jīwěijiǔ
cocktail



葡萄酒
pútáojiǔ
wine



啤酒 pǐjiǔ | beer



一小杯
yì xiǎobēi
a shot

单份
dānfèn
single



量杯
liángbēi
measure

双份
shuāngfèn
double



不加冰
bù jiābīng
without ice

冰和柠檬
bīng hé níngméng
ice and lemon



加冰
jiābīng
with ice

酒吧小吃 jiǔbā xiǎochī • bar snacks



炸薯片 zhàshǔpiàn | crisps

杏仁
xìngrén
almonds

腰果
yāoguǒ
cashewnuts

花生
huāshēng
peanuts



坚果 jiānguǒ | nuts



橄榄 gǎnlǎn | olives

餐馆 cānguǎn • restaurant

禁烟区
jīnyānqū
non-smoking
section

餐巾
cānjīn
napkin

助厨
zhùchú
commis chef



厨房 chúfáng | kitchen

餐具摆放
cānjù bǎifàng
table setting

主厨
zhǔchú
chef

玻璃杯
bōlibēi
glass

托盘
tuōpán
tray



侍者 shìzhě | waiter

词汇 cíhuì • vocabulary

晚餐菜单
wǎncān càidān
evening menu

特色菜
tèsècài
specials

价格
jiàgé
price

小费
xiǎofèi
tip

自助餐
zìzhùcān
buffet

客人
kèrén
customer

酒单
jiǔdān
wine list

按菜单点菜
àn càidān diǎncài
à la carte

账单
zhàngdān
bill

含服务费
hán fúwùfèi
service included

酒吧
jiǔbā
bar

盐
yán
salt

午餐菜单
wǔcān càidān
lunch menu

甜食小车
tiánshí xiǎochē
sweet trolley

收据
shōujù
receipt

不含服务费
bùhán fúwùfèi
service not included

吸烟区
xīyānqū
smoking section

胡椒粉
hújiāofěn
pepper



菜单
càidān
menu



儿童套餐
értóng tàocān
child's meal



点菜 diǎncài | order (v)



付账 fùzhàng | pay (v)

菜肴 cài yáo • courses



开胃酒
kāiwèijiǔ
apéritif



开胃酒
kāiwèijiǔ
starter



汤
tāng
soup



主菜
zhǔcài
main course



配菜
pèicài
side order

餐叉
cānchā
fork



餐后甜点
cānhòu tiándiǎn
dessert

咖啡匙
kāfēichí
coffee spoon



咖啡 kāfēi | coffee

要一张两人桌。
yào yīzhāng liǎngrenzhuō.
A table for two please.

能让我看看菜单/酒单吗？
néng ràng wǒ kànkān càidān/jiǔdān ma?
Can I see the menu/winelist please?

有固定价格菜单吗？
yǒu gùdìng jiàgé càidān ma?
Is there a fixed price menu?

有素食吗？
yǒu sùshí ma?
Do you have any vegetarian dishes?

请给我账单/收据。
qǐng gěi wǒ zhàngdān/shōujù.
Could I have the bill/a receipt please?

我们能分开结账吗？
wǒmen néng fēnkāi jiézhàng ma?
Can we pay separately?

请问卫生间在哪儿？
qǐngwèn wèishēngjiān zài nǎ'èr?
Where are the toilets, please?

快餐 kuàicān • fast food



汉堡包
hànbǎobāo
burger

吸管
xīguǎn
straw

软饮料
ruǎn yǐnliào
soft drink

薯条
shǔtiáo
french fries

餐巾纸
cānjīnzhǐ
paper napkin

托盘
tuōpán
tray

汉堡套餐 hànbǎotàocān | burger meal



比萨饼
bǐsàbǐng
pizza

价目表
jiàmùbiǎo
price list

送餐 sòngcān | home delivery



罐装饮料
guǎnzuāng yǐnliào
canned drink

食品摊 shípǐntān | street stall

词汇 cíhuì • vocabulary

比萨饼店
bǐsàbǐngdiàn
pizza parlour

快餐店
kuàicāndiàn
burger bar

菜单
càidān
menu

店内用餐
diànnèi yòngcān
eat-in

外带
wàidài
take-away

重新加热
chóngxīn jiārè
re-heat (v)

番茄酱
fānqiéjiàng
tomato sauce

我带走吃。
wǒ dàizǒu chī.
Can I have that to go please?

你们提供送餐服务吗？
nǐmen tígòng sòngcānfúwù ma?
Do you deliver?



汉堡包
hànǎobāo
hamburger



鸡肉汉堡
jīròu hànǎo
chicken burger

小圆面包
xiǎoyuán
miànbāo
bun



蔬菜汉堡
shūcài hànǎo
veggie burger

芥末
jièmò
mustard

香肠
xiāngcháng
sausage

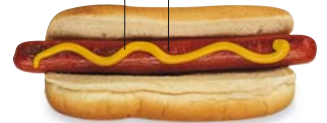

热狗 règǒu | hot dog



三明治
sānmíngzhì
sandwich



总汇三明治
zǒnghuì sānmíngzhì
club sandwich



单片三明治
dānpiàn sānmíngzhì
open sandwich

馅
xiàn
filling



菜卷
càijiǔǎn
wrap



烤肉串
kǎoròuchuàn
kebab

酱
jiàng
sauce



鸡块
jīkuài
chicken nuggets

开胃的
kāiwèide
savoury



薄饼卷 báobǐngjuǎn | crêpes



甜味的
tiánwèide
sweet

装饰配料
zhuāngshìpèiliào
topping



鱼和薯条
yú hé shǔtiáo
fish and chips



肋排
lèipái
ribs



炸鸡
zhājī
fried chicken



比萨饼
bǐsàbǐng
pizza

早餐 zǎocān • breakfast



牛奶 niú'nǎi milk

谷类食品 gǔlèishípǐn cereal

果酱 guǒjiàng jam

干果 gānguǒ dried fruit

火腿 huǒtuǐ ham

奶酪 nǎilǎo cheese

薄脆饼干 báocuǐbǐnggān crispbread

自助早餐 zìzhùzǎocān breakfast buffet

橘子酱 júzǐjiàng marmalade

肉酱 ròujiàng pâté

黄油 huángyóu butter

果汁 guǒzhī fruit juice

咖啡 kāfēi coffee



早餐桌 zǎocānzhuō | breakfast table

热巧克力 rèqiǎokèlì

羊角面包 yángjiǎo miànbāo croissant



茶 chá tea

饮料 yǐnliào | drinks



奶油糕点
nǎiyóugāodiǎn
brioche



面包
miànbāo
bread

烤面包
kāomiànbāo
toast

煎蛋
jiāndàn
fried egg

番茄
fānqiē
tomato

猪血香肠
zhūxuè xiāngcháng
black pudding

香肠
xiāngcháng
sausage

熏肉
xūnròu
bacon

英式早餐
yīngshì zǎocān
English breakfast



熏鲱鱼
xūnfēiyú
kippers



法式吐司
fǎshìtǔsī
french toast

蛋黄
dànhuáng
yolk



煮鸡蛋
zhǔjīdàn
boiled egg

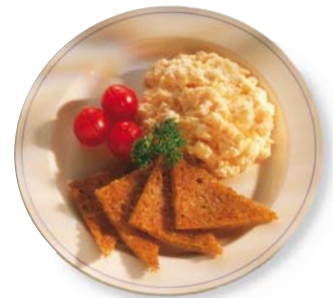

炒鸡蛋
chǎojiǎndàn
scrambled eggs

奶油
nǎiyóu
cream



薄煎饼
báojiānbǐng
pancakes



华夫饼
huáfūbǐng
waffles

果味酸奶
guǒwèisuānnǎi
fruit yoghurt



麦片粥
màipiànzhōu
porridge



鲜果
xiānguǒ
fresh fruit

正餐 zhèngcān • dinner



汤 tāng | soup



肉汤 ròutāng | broth



炖菜 dùncài | stew



咖喱 gālǐ | curry



烤肉 kǎoròu | roast



馅饼 xiànbǐng | pie



蛋奶酥 dànnǎisū | soufflé



烤肉串 kǎoròuchuàn | kebab



肉丸 ròuwán | meatballs



煎蛋饼 jiāndànbǐng | omelette



炒菜 chǎocài | stir fry

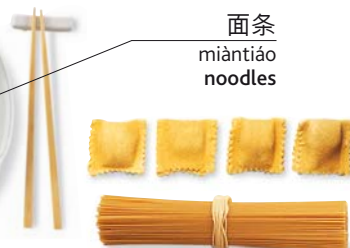

面条 miàntiáo | noodles

意大利面食 yìdàlì miànshí | pasta



米饭 mǐfàn | rice



什锦沙拉 shíjīnshālā | mixed salad



蔬菜沙拉 shūcǎishālā | green salad



酸醋调味汁 suāncù tiáowèizhī | dressing

烹调手法 pēngtiáo shǒufǎ • techniques



装馅 zhuāngxiàn | stuffed



浇汁 jiāozhī | in sauce



烤制 kǎozhì | grilled



醋渍 cùzì | marinated



水煮 shuǐzhǔ | poached



捣成糊状 dǎochénghúzhuàng | mashed



烘制 hōngzhì | baked



煎制 jiānzhì | pan fried



炒制 chǎozhì | fried



腌渍 yānzì | pickled



熏制 xūnzhì | smoked



油炸 yóuzhá | deep fried



枫糖浸泡 fēngtángjìnpào
in syrup



调味 tiáowèi | dressed



清蒸 qīngzhēng | steamed



风干 fēnggān | cured





学习 xuéxí
study

学校 xuéxiào • school

老师
lǎoshī
teacher

黑板
hēibǎn
blackboard



教室 jiàoshì | classroom



男生 nánshēng | schoolboy

学生
xuéshēng
pupil

校服
xiàofú
school uniform

课桌
kèzhuō
desk

书包
shūbāo
school bag

粉笔
fēnbǐ
chalk



女生
nǚshēng
schoolgirl

词汇 cíhuì • vocabulary

历史
lìshǐ
history

自然科学
zìránkēxué
science

物理
wùlǐ
physics

语言
yǔyán
languages

艺术
yìshù
art

化学
huàxué
chemistry

文学
wénxué
literature

音乐
yīnyuè
music

生物学
shēngwùxué
biology

地理
dìlǐ
geography

数学
shùxué
maths

体育
tǐyù
physical
education

学习活动 xuéxí huódòng • activities



读 dú | read (v)



写 xiě | write (v)



拼写 pīnxiě | spell (v)



画 huà | draw (v)



幻灯机
huàndēngjī
overhead projector



钢笔
gāngbǐ
pen



铅笔
qiānbǐ
pencil

彩色铅笔
cǎisèqiānbǐ
colouring pencil



转笔刀
zhuǎnbǐdāo
pencil sharpener



橡皮
xiàngpí
rubber



教科书 jiàokeshū | textbook



笔袋 bǐdài | pencil case



尺子 chǐzi | ruler



提问 tíwèn | question (v)



回答 huídá | answer (v)



讨论 tāolùn | discuss (v)



学习 xuéxí | learn (v)

词汇 cíhuì • vocabulary

校长
xiàozhǎng
head teacher

答案
dànw
answer

评分
píngfēn
grade

课
kè
lesson

作业
zuòyè
homework

年级
niánjí
year

问题
wèntí
question

考试
kǎoshì
examination

字典
zìdiǎn
dictionary

记笔记
jìbǐjì
take notes (v)

作文
zuòwén
essay

百科全书
bǎikēquánshū
encyclopedia

数学 shùxué • maths

平面图形 píngmiàntúxíng • shapes

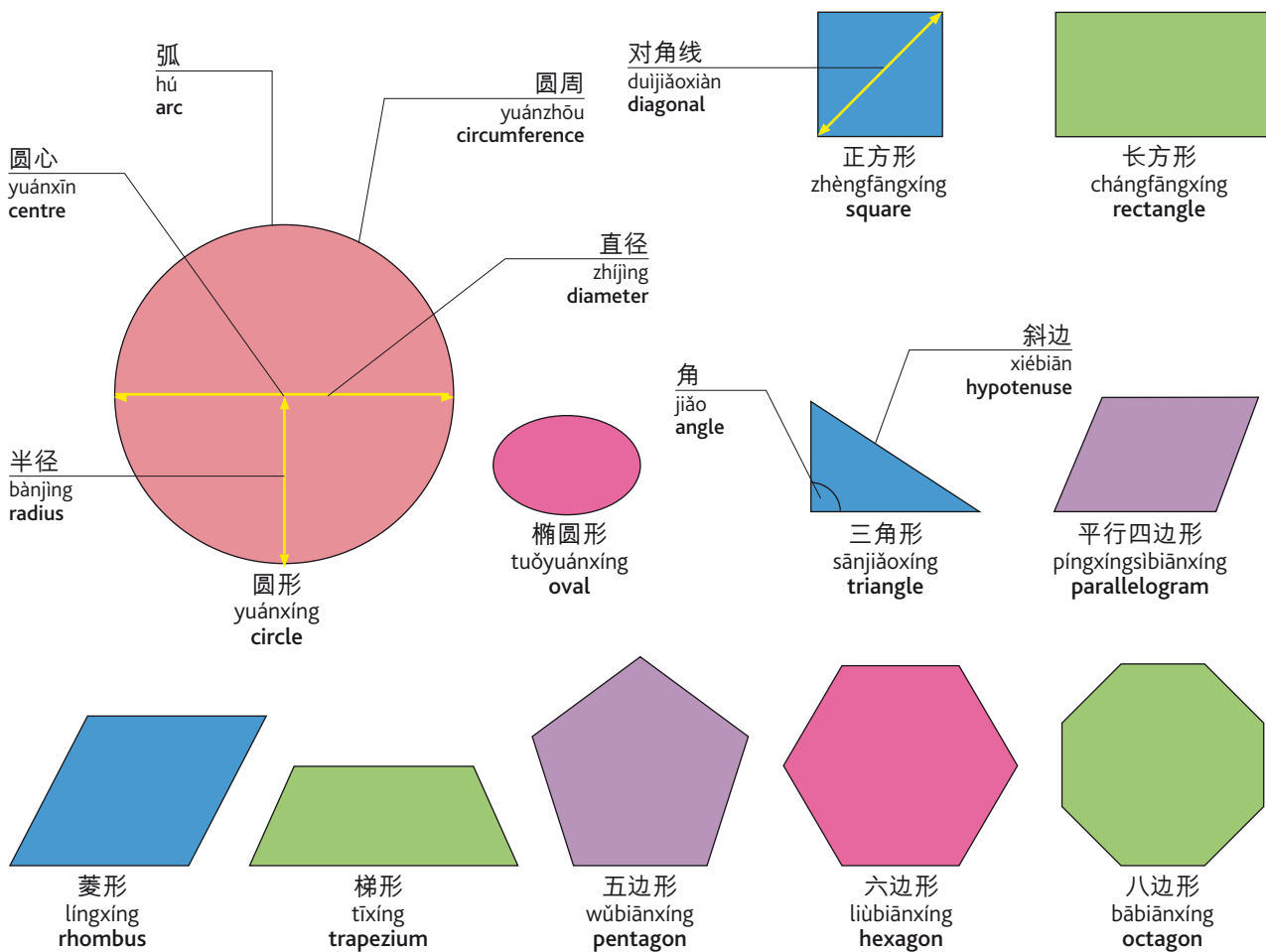

立体 lìtǐ • solids

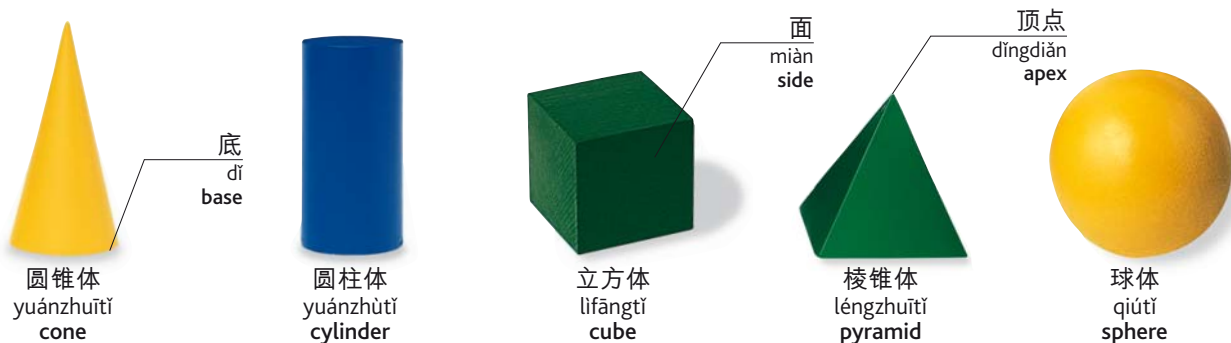

线 xiàn • lines



度量 dùliàng • measurements

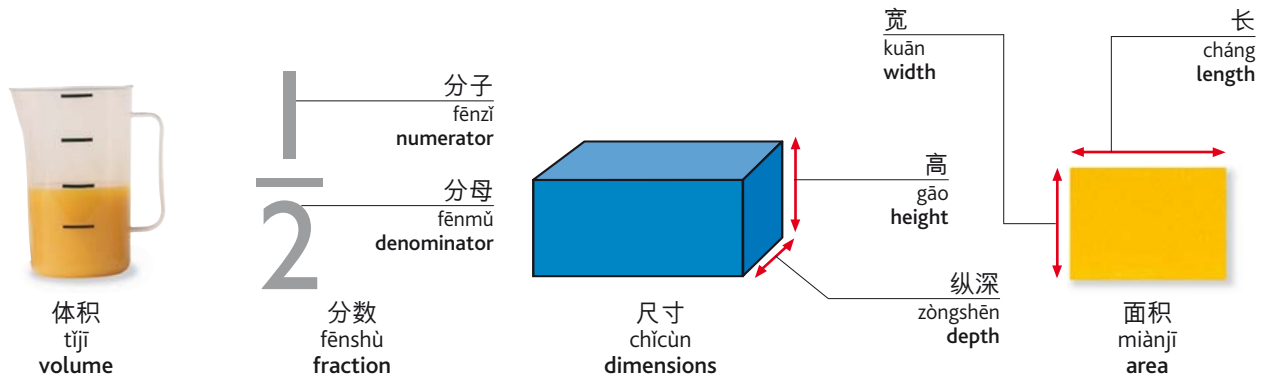

学习用具 xuéxíyòngjù • equipment

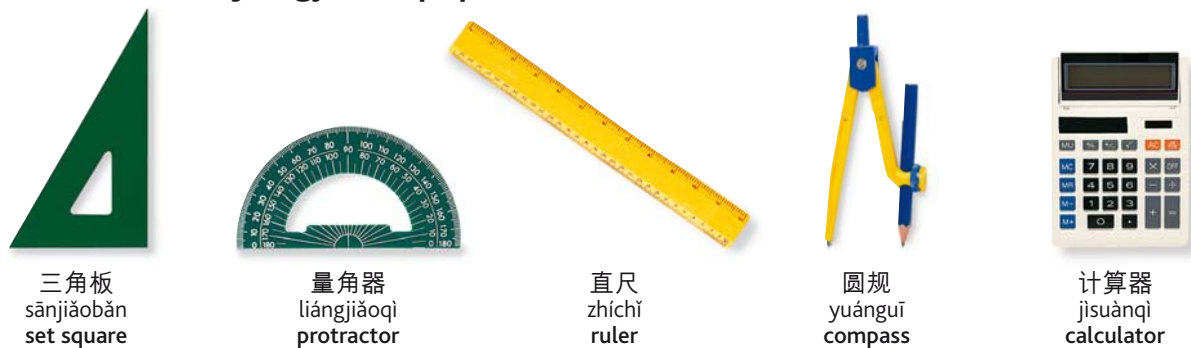

词汇 cíhuì • vocabulary

几何 jǐhé geometry	正 zhèng plus	倍 bèi times	等于 děngyú equals	加 jiā add (v)	乘 chéng multiply (v)	等式 děngshì equation
算术 suànshù arithmetic	负 fù minus	除以 chúyǐ divided by	计数 jìshù count (v)	减 jiǎn subtract (v)	除 chú divide (v)	百分比 bǎifēnbǐ percentage

科学 kēxué • science



实验室
shíyànshì
laboratory

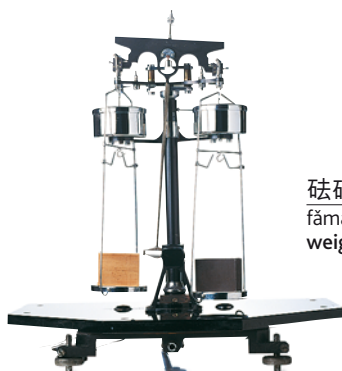

天平
tiānpíng
scales

砝码
fǎmǎ
weight

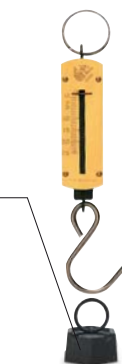

弹簧秤
tánhuángchèng
spring balance

坩埚
gānguō
crucible

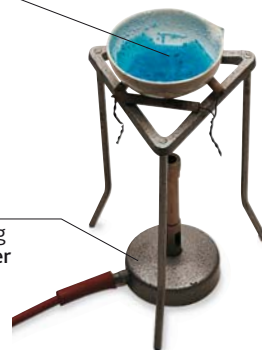

本生灯
běnshēngdēng
bunsen burner

三脚架
sānjiǎojià
tripod



玻璃瓶
bōlipíng
glass bottle

漏斗
lòudǒu
funnel

烧瓶
shāopíng
flask

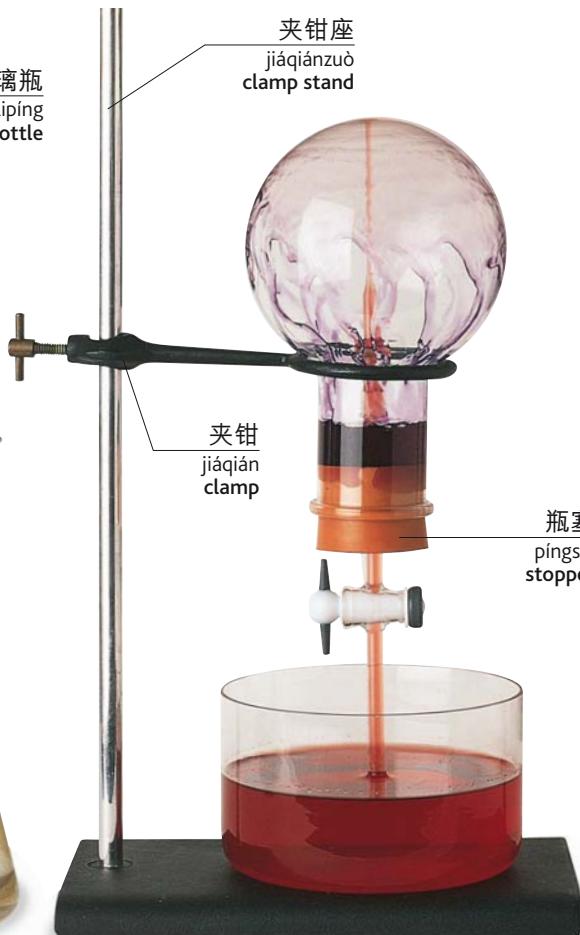

夹钳座
jiáqiánzuò
clamp stand

夹钳
jiáqián
clamp

瓶塞
píngsāi
stopper

实验 shíyàn | experiment

试管
shìguǎn
test tube



试管架
shìguǎnjià
rack



计时器
jìshíqì
timer



培养皿
péiyǎngmǐn
petri dish



温度计
wēndùjì
thermometer



注射器
zhùshèqì
syringe



镊子
nièzi
tweezers



解剖刀
jiěpōudāo
scalpel



滴管 dīguǎn | dropper



医用钳 yīyòngqián | forceps



钳子 qiánzi | tongs



刮刀 guādāo | spatula

研杵
yánchǔ
pestle



研钵
yánbō
mortar



滤纸
lǜzhǐ
filter paper



护目镜
hù mù jìng
safety goggles

目镜
mù jìng
eyepiece

调焦旋钮
tiáojiāoxuǎnniǔ
focusing knob



物镜
wù jìng
objective lens

载物台
zǎiwùtái
stage

载玻片
zǎibōpiàn
slide

反射镜
fǎnshè jìng
mirror

显微镜 xiǎnwēijìng | microscope



玻璃棒
bōlibàng
glass rod



烧杯
shāobēi
beaker

吸管
xīguǎn
pipette



磁铁
cítiè
magnet



鳄鱼夹
èyújiá
crocodile clip

负极
fùjī
negative electrode



正极
zhèngjī
positive electrode

电池 diàncí | battery

高等院校 gāoděngyuànxìào • college

招生办
zhāoshēngbàn
admissions

学生食堂
xuéshēngshítáng
refectory

健康中心
jiànkāngzhōngxīn
health centre



校园 xiàoyuán | campus

运动场
yùndòngchǎng
sports field

学生宿舍
xuéshēngsùshè
hall of
residence

书目
shūmù
catalogue

图书管理员
túshūguǎnlǐyuán
librarian



借书处
jièshūchù
loans desk

书架
shūjià
bookshelf

期刊
qīkān
periodical

杂志
zázhì
journal



图书馆 túshūguǎn | library

词汇 cíhuì • vocabulary

借书证
jièshūzhèng
library card

问询处
wènxúnchù
enquiries

借出
jièchū
loan

阅览室
yuèlǎnshì
reading room

借入
jièrù
borrow (v)

书
shū
book

推荐书目
tuījiànrshūmù
reading list

预订
yùdìng
reserve (v)

书名
shūmíng
title

还书日期
huánshūrìqī
return date

续借
xùjiè
renew (v)

走廊
zǒuláng
aisle

大学生
dàxuéshēng
undergraduate

讲师
jiǎngshī
lecturer



阶梯教室 jiētījiàoshì | lecture theatre

毕业生
bìyèshēng
graduate

学位袍
xuéwèipào
robe



毕业典礼 bìyèdiǎnlǐ | graduation ceremony

高等专科学校 gāoděngzhuānkē xuéxiào • schools



美术学院 měishùxuéyuàn
art college

模特
móte
model



音乐学院 yīnyuèxuéyuàn
music school



舞蹈学院 wǔdǎoxuéyuàn
dance academy

词汇 cíhuì • vocabulary

奖学金
jiǎngxuéjīn
scholarship

研究
yánjiū
research

(学位) 论文
(xuéwèi) lùnwén
dissertation

医学
yīxué
medicine

哲学
zhéxué
philosophy

文凭
wénpíng
diploma

硕士学位
shuòshìxuéwèi
masters

系
xì
department

动物学
dòngwùxué
zoology

文学
wénxué
literature

学位
xuéwèi
degree

博士学位
bóshìxuéwèi
doctorate

法律
fǎlǚ
law

物理学
wùlǐxué
physics

艺术史
yìshùshǐ
history of art

研究生阶段的
yánjiūshēng
jiēduānde
postgraduate

论文
lùnwén
thesis

工程学
gōngchéngxué
engineering

政治学
zhèngzhìxué
politics

经济学
jīngjìxué
economics

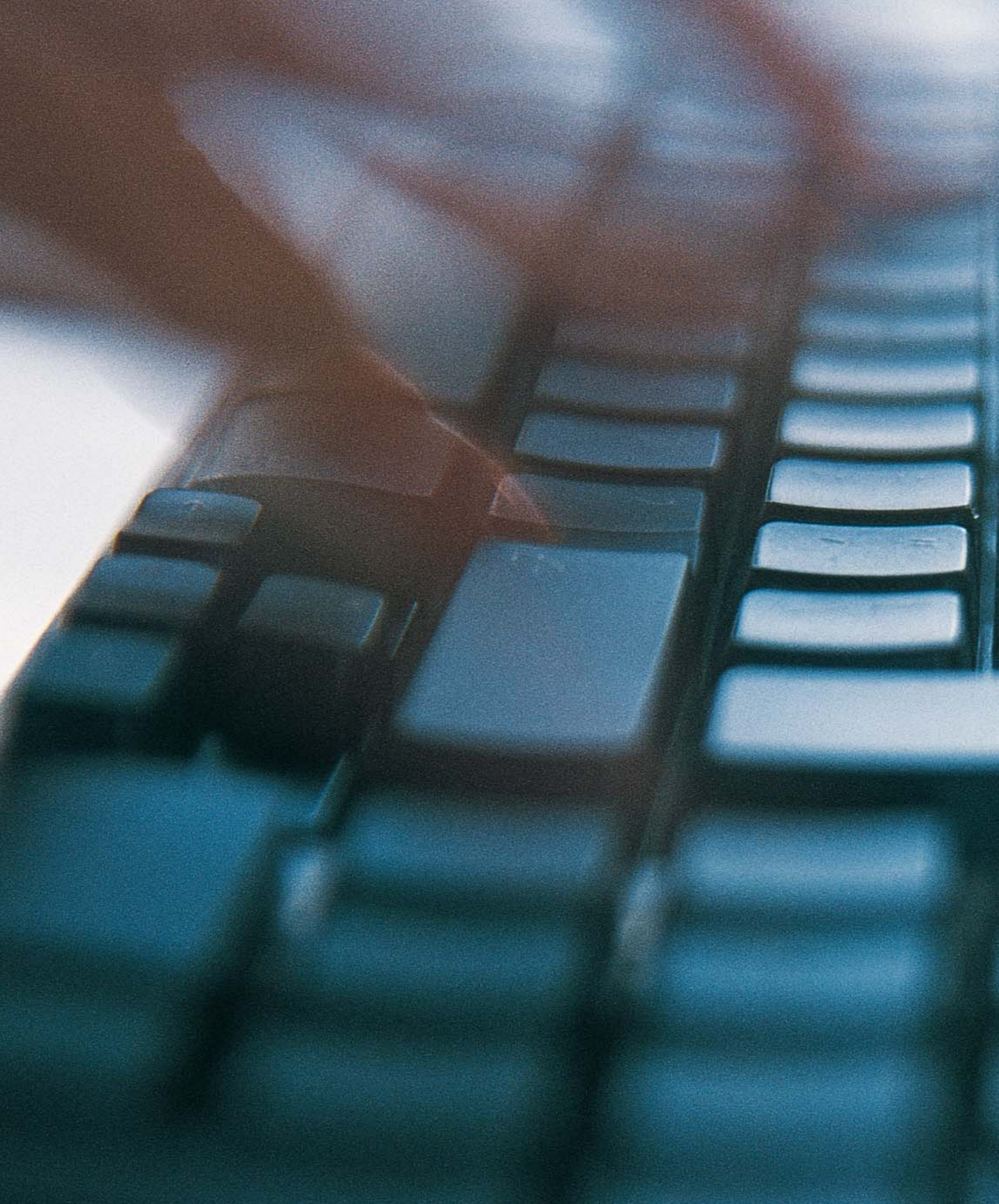



工作 gōngzuò
work

办公室1 bàngōngshìyī • office 1

办公室 bàngōngshì • office



办公设备 bàngōngshèbèi • office equipment



词汇 cíhuì • vocabulary

打印 dǎyìn print (v)

放大 fàngdà enlarge (v)

复印 fùyìn copy (v)

缩小 suōxiǎo reduce (v)

我要复印。
wǒ yào fùyìn.
I need to make some copies.

办公用品 bàngōngyòngpǐn • office supplies



礼帖
lǐtiē
compliments slip

印有笺头的信纸
yìn yǒu jiāntóude xìnzhǐ
letterhead



信封
xìnfēng
envelope

文件盒
wénjiàn hé
box file



分隔页
fēnggé yè
divider

盒式文件夹
héshì wénjiànjiā
lever arch file



带纸夹的笔记本
dài zhǐjiā de bǐjìbǎn
clipboard



便笺
biànjiān
note pad



标签
biāoqiān
tab

悬挂式文件夹
xuànguāshì wénjiànjiā
hanging file



格式文件夹
géshì wénjiànjiā
concertina file



备忘录
bèiwànglù
personal organizer



订书钉
dìngshūding
staples

透明胶带
tòumíngjiāodài
sticky tape



胶带架
jiāodàijià
tape dispenser



打孔器
dǎkǒngqì
hole punch



印台
yìntái
ink pad

橡皮图章
xiàngpítúzhāng
rubber stamp



皮筋
píjīn
rubber band



强力纸夹
qiánglìzhǐjiā
bulldog clip



曲别针
qūbiézhēn
paper clip

图钉
túding
drawing pin



公告栏 gōnggàolán | notice board

办公室2 bàngōngshì'èr • office 2



活动挂图
huódòngguàtú
flipchart

会议记录
huìyìjìlù
minutes

挂图架
guàtújià
easel

报告
bàogào
report

经理
jīnglǐ
manager

提案
tí'àn
proposal

主管
zhǔguǎn
executive

会议 huìyì | meeting

词汇 cíhuì • vocabulary

会议室
huìyìshì
meeting room

议程
yìchéng
agenda

什么时候开会？
shénme shíhòu kāihuì？
What time is the meeting?

您几点上下班？
nín jǐdiǎn shàngxiàbān？
What are your office hours?

参加
cānjiā
attend (v)

主持
zhǔchí
chair (v)



幻灯机
huàndēngjī
projector

讲解人
jiǎngjiěrén
speaker

介绍 jièshào | presentation

商务 shāngwù • business

笔记本电脑
bǐjìběn diànnǎo
laptop

笔记
bǐjì
notes

商人
shāngrén
businessman

女商人
nǚshāngrén
businesswoman



工作午餐 gōngzuòwǔcān | business lunch



商务旅行 shāngwùlǚxíng | business trip



客户
kèhù
client
约会
yuēhuì
appointment

掌上电脑
zhǎngshàng diànnǎo
palmtop

客户 kèhù | diary



总经理
zǒngjīnglǐ
managing
director

商业交易 shāngyèjiāoyì | business deal

词汇 cíhuì • vocabulary

公司
gōngsī
company

员工
yuángōng
staff

会计部
kuàijìbù
accounts department

法律事务部
fǎlǚshìwùbù
legal department

总部, 总公司
zǒngbù, zǒnggōngsī
head office

薪水
xīnshuǐ
salary

市场部
shìchǎngbù
marketing department

客户服务部
kèhùfúwùbù
customer service department

分部, 分公司
fēnbù, fēngōngsī
branch

工资单
gōngzīdān
payroll

销售部
xiāoshòubù
sales department

人力资源部
rénlìzīyuánbù
personnel department

计算机 jìsuànjī • computer



笔记本电脑 bǐjìběn diànnǎo | laptop



软盘 ruǎnpán | disk

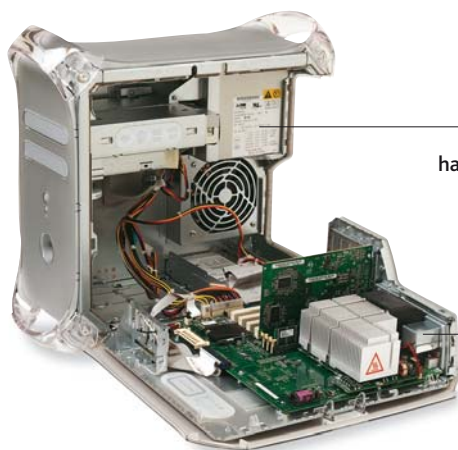

硬盘 yǐngpán hard drive

调制解调器 tiáozhìjiětiáoqì modem

词汇 cíhuì • vocabulary

存储器 cúnchǔqì
memory

软件 ruǎnjiàn
software

服务器 fúwùqì
server

随机存储器 suíjī cúnchǔqì
RAM

应用程序 yīngyòng chéngxù
application

端口 duānkǒu
port

字节 zìjié
bytes

程序 chéngxù
program

处理器 chǔlǐqì
processor

系统 xìtǒng
system

网络 wǎngluò
network

电源线 diànyuánxiàn
power cable

桌面 zhuōmiàn • desktop

菜单栏
càidānlán
menubar

工具栏
gōngjùlán
toolbar

桌面背景
zhuōmiàn bèijǐng
wallpaper

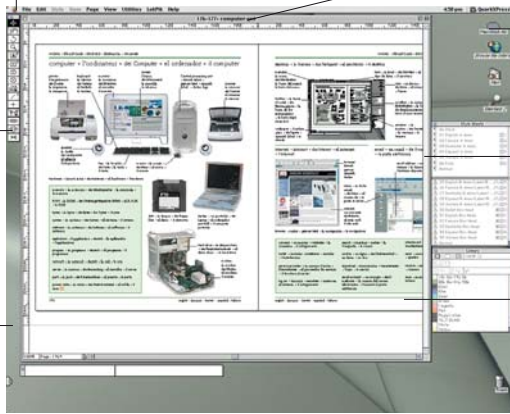

字体
zìtǐ
font

图标
túbiāo
icon

滚动条
gǔndòngtiáo
scrollbar

视窗
shìchuāng
window



互联网 hùliánwǎng • internet



浏览 liúlǎn | browse (v)

浏览器
liúlǎnqǐ
browser

收件箱
shōujiànxiāng
inbox

网站
wǎngzhàn
website

电子邮件 diànzǐyóujiàn • email

电子邮件地址
diànzǐyóujiàn dìzhǐ
email address

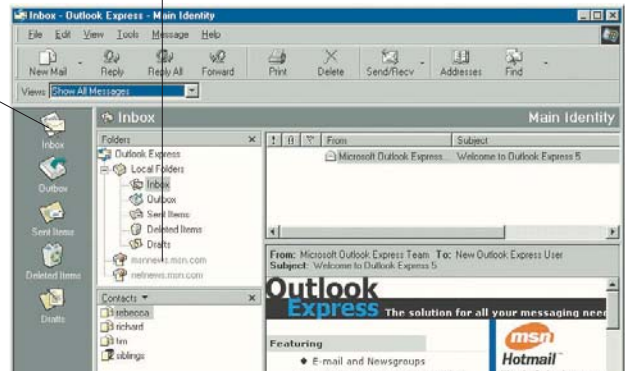

词汇 cíhuì • vocabulary

连接
liánjiē
connect (v)

服务商
fúwùshāng
service provider

登录
dēnglù
log on (v)

下载
xiàzài
download (v)

发送
fāsòng
send (v)

保存
bǎocún
save (v)

安装
ānzhuāng
instal (v)

电子邮件账户
diànzǐyóujiàn zhànghù
email account

在线
zàixiàn
on-line

附件
fùjiàn
attachment

接收
jiēshōu
receive (v)

搜索
sōusuo
search (v)

媒体 méitǐ • media

电视演播室 diànshì yǎnbōshì • television studio

节目主持人
jiémùzhǔchíren
presenter

照明
zhàomíng
light

布景
bùjǐng
set



摄像机
shèxiàngjī
camera

摄像机升降器
shèxiàngjī shēngjiàngqì
camera crane

摄像师
shèxiàngshī
cameraman

词汇 cíhuì • vocabulary

频道
píndào
channel

新闻
xīnwén
news

新闻媒体
xīnwénméitǐ
press

肥皂剧
féizàojù
soap

动画片
dònghuàpiān
cartoon

直播
zhíbō
live

节目编排
jiémùbiānpái
programming

纪录片
jìlùpījiànpiān
documentary

电视连续剧
diànshì liánxùjù
television
series

游戏节目
yóuxìjiémù
game show

录播
lùbō
prerecorded

播放
bōfàng
broadcast (v)



采访记者 cǎifǎngjìzhě
interviewer



记者 jìzhě | reporter



自动提示机 zìdòngtíshìjī
autocue



新闻播音员 xīnwénbōyīnyuán
newsreader



演员 yǎnyuán | actors



录音吊杆 lùyīndiàogǎn
sound boom



场记板 chǎngjìbǎn
clapper board



电影布景 diànyǐngbùjǐng
film set

无线电广播 wúxiàndiànguǎngbō • radio

混音台
húnyīntái
mixing desk

话筒
huàtǒng
microphone

录音师
lùyīnshī
sound technician



录音室 lùyīnshì | recording studio

词汇 cíhuì • vocabulary

广播电台
guǎngbōdiàntái
radio station

中波
zhōngbō
medium wave

广播
guǎngbō
broadcast

频率
pínlǜ
frequency

波长
bōcháng
wavelength

音量
yīnliàng
volume

长波
chángbō
long wave

调音
tiáoyīn
tune (v)

短波
duǎnbō
short wave

流行音乐节目主持人
liúxíngyīnyuè jiémù
zhǔchírén
DJ

法律 fǎlǜ • law

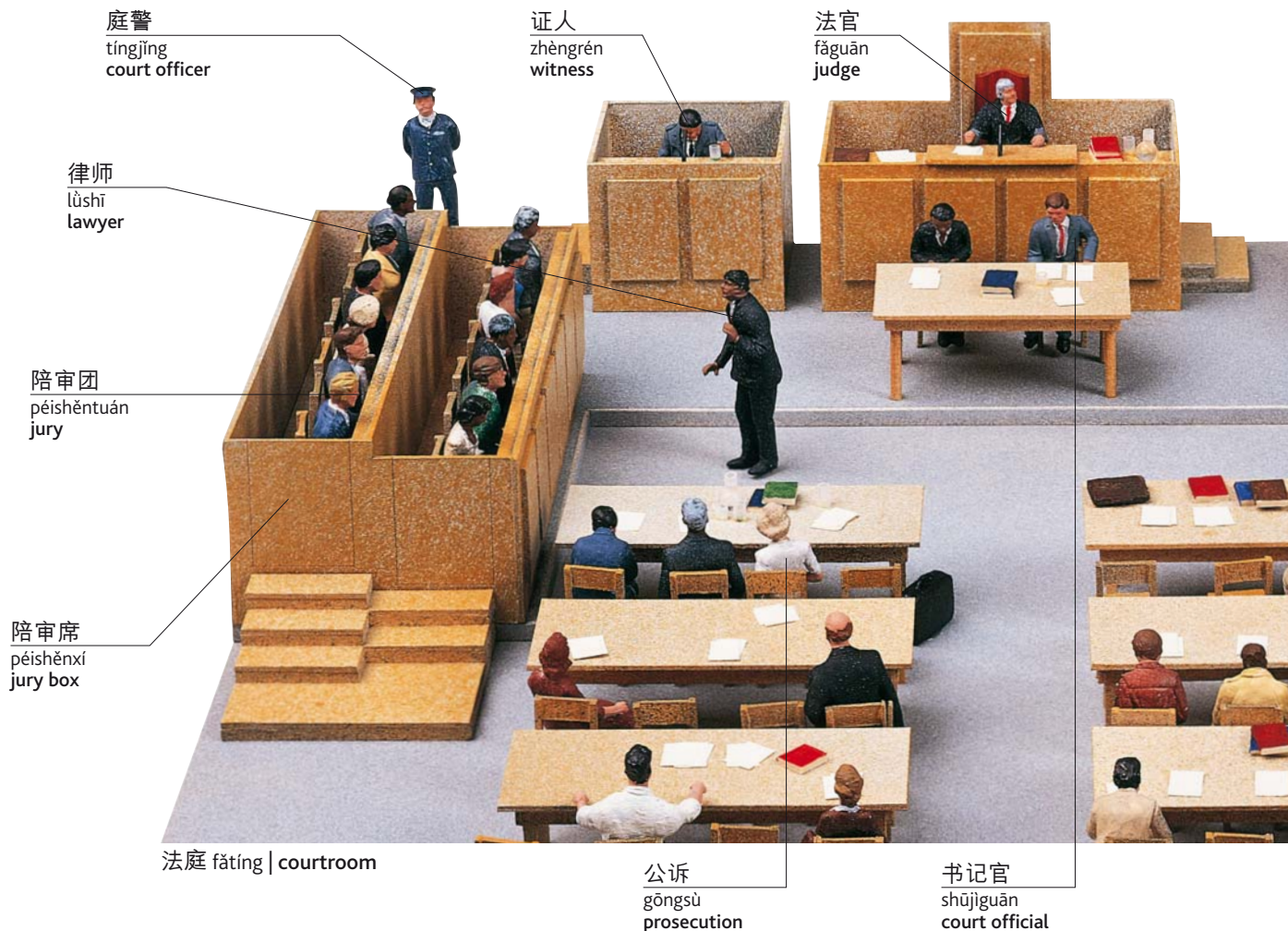

词汇 cíhuì • vocabulary

律师事务所
lǜshīshìwùsuǒ
lawyer's office

法律咨询
fǎlǜzixún
legal advice

诉讼委托人
sùsòngwěituōrén
client

传讯
chuánxùn
summons

陈辞
chéncí
statement

逮捕令
dàibǔlìng
warrant

传票
chuánpiào
writ

开庭日
kāitīngrì
court date

抗辩
kàngbiàn
plea

诉讼案件
sùsòng ànjiàn
court case

控告
kònggào
charge

被告
bèigào
accused



速记员
sùjìyuán
stenographer

嫌疑犯
xiányífàn
suspect

被告人
bèigāorén
defendant

应诉方
yìngsùfāng
defence



狱警 yùjǐng | prison guard



拼凑人像 pīncòurénxiàng | photofit



罪犯 zuìfàn
criminal
犯罪记录 fànzuìjìlù | criminal record



单人牢房 dānrénláofáng
cell



监狱 jiānyù | prison

词汇 cíhuì • vocabulary

证据
zhèngjù
evidence

有罪
yǒuzuì
guilty

保释金
bǎoshìjīn
bail

我要见律师。
wǒ yào jiàn lǚshī.
I want to see a lawyer.

判决
pànjué
verdict

无罪释放
wúzuìshìfàng
acquitted

上诉
shàngsù
appeal

法院在哪儿？
fǎyuàn zài nǎ'èr?
Where is the courthouse?

无罪
wúzuì
innocent

判刑
pàn xíng
sentence

假释
jiǎshì
parole

我可以保释吗？
wǒ kěyǐ bǎoshì ma?
Can I post bail?

农场1 nóngchǎngyī • farm 1



农民
nóngmín
farmer

菜地
càidì
vegetable plot

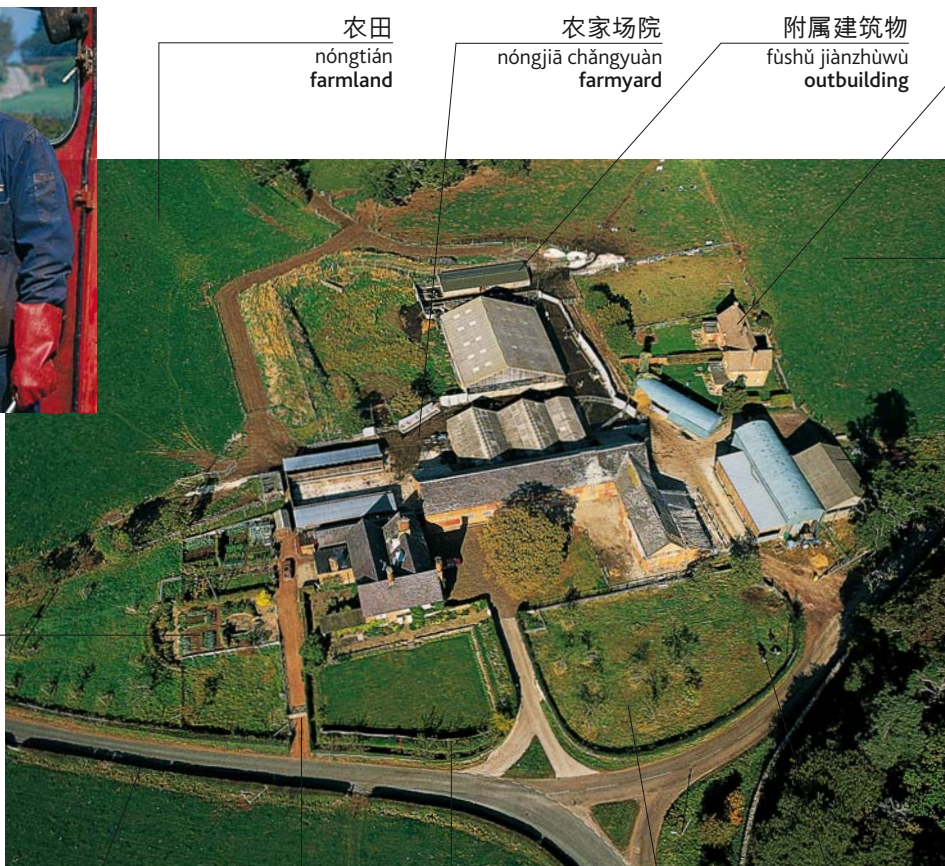

农田
nóngtián
farmland

农家场院
nóngjiā chǎngyuàn
farmyard

附属建筑物
fùshǔ jiànzhùwù
outbuilding

农舍
nóngshè
farmhouse

田地
tiándì
field

谷仓
gǔcāng
barn

树篱
shùlí
hedge

大门
dàmén
gate

围栏
wéilán
fence

牧场
mùchǎng
pasture

家畜
jiāchù
livestock



拖拉机 tuōlājī | tractor

中耕机
zhōnggēngjī
cultivator



联合收割机 liánhéshōugējī | combine harvester

农场类型 nóngchǎng lèixíng • types of farm

庄稼

zhuāngjia
crop

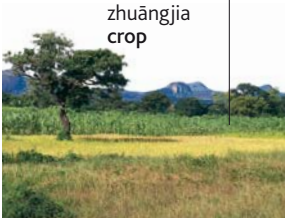

种植园
zhòngzhíyuán
arable farm

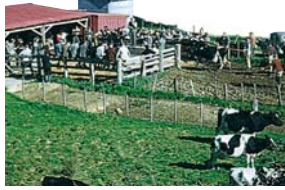

乳牛场
rǔniúchǎng
dairy farm



牧羊场
mùyángchǎng
sheep farm

羊群
yángqún
flock



养鸡场 yǎngjīchǎng
poultry farm

葡萄树

pútáoshù
vine

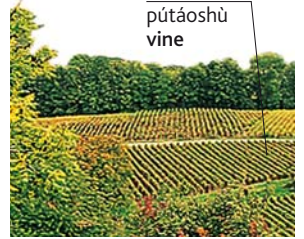

葡萄园
pútáoyuán
vineyard



养猪场
yǎngzhūchǎng
pig farm



养鱼场
yǎngyúchǎng
fish farm



果园
guǒyuán
fruit farm

农活 nóng huó • actions

犁

lí
furrow



犁地
lídì
plough (v)



播种
bōzhǒng
sow (v)



挤奶
jǐ'nǎi
milk (v)

饲养
sìyǎng
feed (v)



灌溉 guàngài | water (v)



收获 shōuhuò | harvest (v)

词汇 cíhuì • vocabulary

除草剂
chúcǎoji
herbicide

牧群
mùqún
herd

饲料槽
sìliàocáo
trough

杀虫剂
shāchóngji
pesticide

地窖
dìjiào
silo

种植
zhòngzhí
plant (v)

农场2 nóngchǎng'èr • farm 2

农作物 nóngzuòwù • crops



小麦
xiǎomài
wheat



玉米
yùmǐ
corn



大麦
dàmài
barley



油菜籽
yóucàizi
rapeseed



向日葵
xiàngrikuí
sunflower



捆包
kǔnbāo
bale

干草
gāncǎo
hay



紫花苜蓿
zǐhuāmùxū
alfalfa



烟草
yāncǎo
tobacco



水稻
shuǐdào
rice



茶
chá
tea



咖啡
kāfēi
coffee



亚麻
yàmá
flax



甘蔗
gānzhe
sugarcane



棉花
miánhuā
cotton



稻草人
dàocǎorén
scarecrow

家畜 jiāchù • livestock

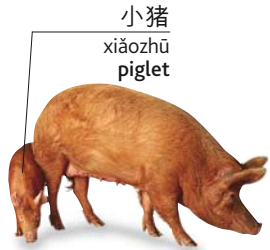

小猪
xiǎozhū
piglet

猪
zhū
pig

牛犊
niú dú
calf

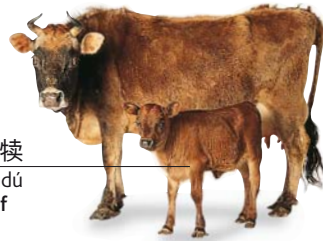

母牛
mǔniú
cow



公牛
gōngniú
bull



绵羊
miányáng
sheep



羊羔
yánggāo
lamb



小山羊
xiǎoshānyáng
kid

山羊
shānyáng
goat



马驹
mǎjū
foal

马
mǎ
horse



驴
lǘ
donkey

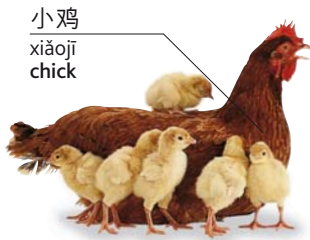

小鸡
xiǎojī
chick

鸡
jī
chicken



公鸡
gōngjī
cockerel



火鸡
huǒjī
turkey

小鸭
xiǎoyā
duckling



鸭
yā
duck



马厩
mǎjiù
stable



家畜圈
jiāchùquān
pen



鸡舍
jīshè
chicken coop



猪圈
zhūjuàn
pigsty

建筑 jiànzhù • construction

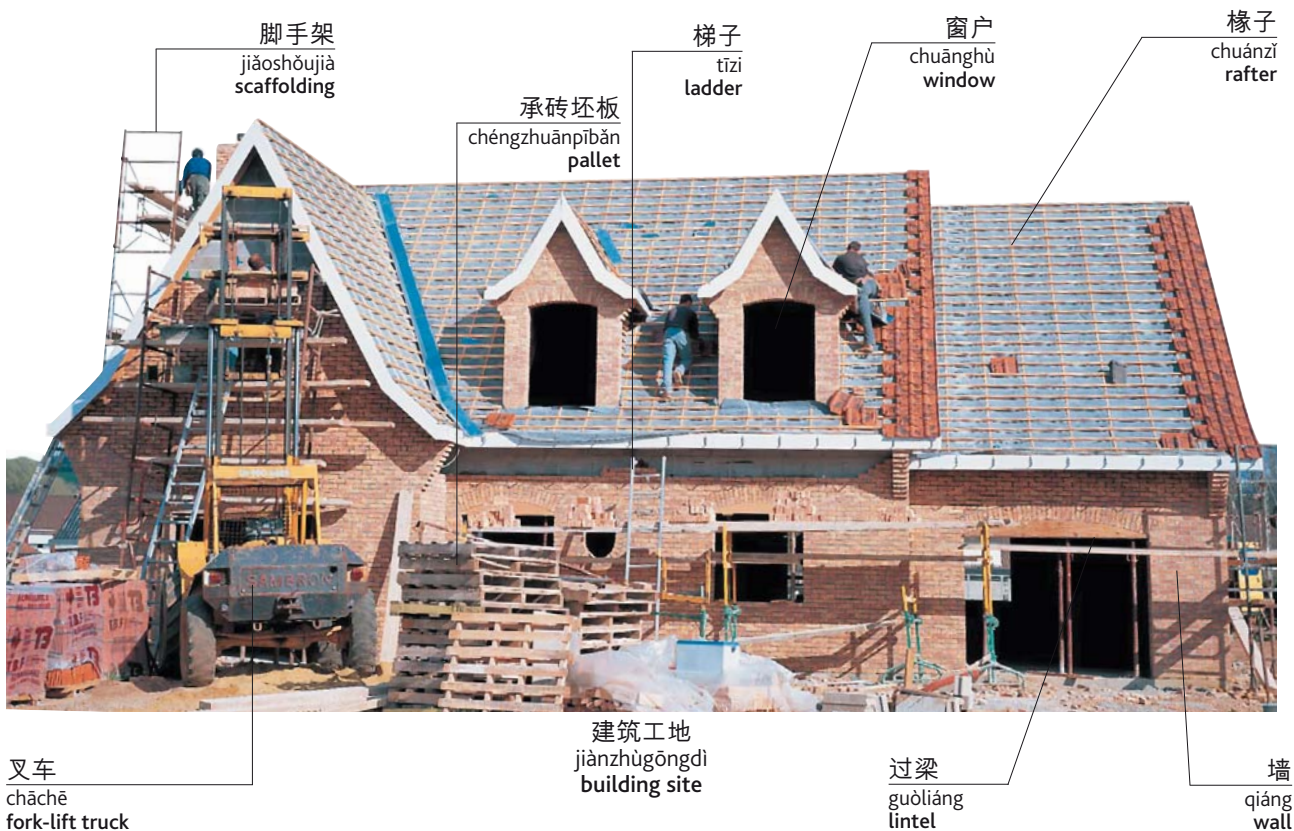

建造 jiànào build (v)

建筑材料 jiànzhù cáiliào • materials



砖
zhuān
brick



木材
mùcái
timber



瓦片
wǎpiàn
roof tile



混凝土块
hùnníngtǔkuài
concrete block

工具 gōngjù • tools

灰浆
huījiāng
mortar



抹刀
mǒdāo
trowel



水准仪
shuǐzhǔnyí
spirit level



大锤
dàchuí
sledgehammer



柄
bǐng
handle
丁字镐
dīngzìgǎo
pickaxe



铁锹
tiěqiāo
shovel

(工程)机械 (gōngchéng) jīxiè • machinery



压路机
yālùjī
roller



翻斗卡车
fāndǒukǎchē
dumper truck



吊钩
diàogōu
hook

起重机 qǐzhòngjī | crane

支座
zhīzuò
support

道路施工 dào lù shī gōng • roadworks

柏油路面
bǎiyóulùmiàn
tarmac

锥形隔离墩
zhuīxínggélidūn
cone



风钻
fēngzuàn
pneumatic drill



重铺路面
zhòngpū lùmiàn
resurfacing

挖掘机
wājuéjī
mechanical digger

职业1 zhíyèyī • occupations 1



木匠
mùjiàng
carpenter



电工
diàngōng
electrician



水暖工
shuǐnuǎngōng
plumber



建筑工人
jiànzhùgōngrén
builder



园丁
yuándīng
gardener

吸尘器
xīchénqì
vacuum
cleaner



清洁工
qīngjiégōng
cleaner



机械师
jīxièshī
mechanic



屠户
túhù
butcher

剪刀
jiǎndāo
scissors



美发师
měifàshī
hairdresser



鱼贩
yúfàn
fishmonger



蔬菜水果商
shūcài shuǐguǒshāng
greengrocer



花商
huāshāng
florist



理发师
lǐfàshī
barber



珠宝匠
zhūbǎojiàng
jeweller



售货员
shòuhuòyuán
shop assistant



房地产商
fángdìchǎnshāng
estate agent



配镜师
pèijìngshī
optician



牙医
yáyī
dentist



医生
yīshēng
doctor

口罩
kǒuzhào
mask



药剂师
yàojìshī
pharmacist



护士
hùshī
nurse



兽医
shòuyī
vet

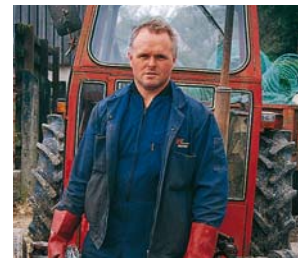

农民
nóngmín
farmer



渔民
yúmín
fisherman

机枪
jīqiāng
machine-gun



士兵
shìbīng
soldier



警察
jǐngchá
policeman

徽章
huīzhāng
identity badge

制服
zhìfú
uniform



保安
bǎoān
security guard



水手
shuǐshǒu
sailor



消防队员
xiāofángduìyuán
fireman

职业2 zhíyè'èr • occupations 2



律师
lǚshī
lawyer



会计师
kuàijìshī
accountant



模型
mó xíng
model

建筑师 jiànzhùshī | architect



科学家
kēxuéjiā
scientist



老师
lǎoshī
teacher



图书管理员
túshūguǎnlǐyuán
librarian



接待员
jiēdàiyuán
receptionist



邮袋
yóudài
mailbag

邮递员
yóudìyuán
postman



公共汽车司机
gōnggòngqìchē sījī
bus driver



卡车司机
kǎchē sījī
lorry driver



出租车司机
chūzūchē sījī
taxi driver



飞行员
fēixíngyuán
pilot



空中小姐
kōngzhōngxiǎojiě
air stewardess



旅行代理
lǚxíngdàilǐ
travel agent

厨师帽
chúshīmào
chef's hat



厨师
chúshī
chef



音乐家
yīnyuèjiā
musician



芭蕾舞裙
bālěiwǔqún
tutu

舞蹈演员
wǔdǎoyǎnyuán
dancer



演员
yǎnyuán
actor



歌手
gēshǒu
singer



女侍者
nǚshìzhě
waitress



酒保
jiǔbǎo
barman



运动员
yùndòngyuán
sportsman



雕塑家
diāosùjiā
sculptor



画家
huàjiā
painter



摄影师
shèyǐngshī
photographer



新闻播音员
xīnwén bōyīnyuán
newsreader



笔记
bǐjì
notes

新闻记者
xīnwén jìzhě
journalist



编辑
biānjí
editor



制图员
zhìtúyuán
designer



女缝纫师
nǚféngrènshī
seamstress



裁缝
cáiféng
tailor





交通运输 jiāotōngyùnshū
transport

道路 dào lù • roads

高速公路
gāosùgōnglù
motorway

收费站
shōufèizhàn
toll booth

路面标志
lùmiànbiāozhì
road markings

主路入口
zhǔlùrùkǒu
slip road

单行
dānxíng
one-way

隔离带
gélídài
divider

交汇处
jiāohuìchù
junction

交通信号灯
jiāotōng
xínghàodēng
traffic light

载重汽车
zàizhòngqìchē
lorry

中央分车道
zhōngyāng fēnchēdài
central reservation

高架桥下通道
gāojià qiáoxià tōngdào
underpass

内车道
nèichēdào
inside lane

中央车道
zhōngyāngchēdào
middle lane

外车道
wàichēdào
outside lane

出口
chūkǒu
exit ramp

交通
jiāotōng
traffic

立交桥
lǐjiāoqiáo
flyover

硬质路肩
yìngzhìlùjiān
hard shoulder





人行横道
rénxínghéngdào
pedestrian crossing



求救电话
qiújiù diànhuà
emergency phone



残疾人停车处
cánjírén tíngchēchù
disabled parking



人行横道
rénxínghéngdào
traffic jam

地图
ditú
map



停车计时收费器
tíngchē jìshí shōufèiqì
parking meter



交通警察
jiāotōng jǐngchá
traffic policeman



词汇 cíhuì • vocabulary

道路交叉处的
环形路
dàolù
jiāochāchùde
huánxínglù
roundabout

(有中央分隔带的)
复式车道
(yǒu zhōngyāng
fēnggédài)
fùshì chēdào
dual
carriageway

超车
chāochē
overtake (v)

拖走
tuōzǒu
tow away (v)

绕行道路
ràoxíngdàolù
diversion

停车
tíngchē
park (v)

这是去... 的路吗?
zhèshìqù... de lù ma?
Is this the road to...?

道路施工
dàolùshīgōng
roadworks

驾驶
jiàoshǐ
drive (v)

哪里可以停车?
nǎlǐ kěyǐ tíngchē?
Where can I park?

防撞护栏
fángzhuànghùlán
crash barrier

倒车
dàoche
reverse (v)

交通标志 jiāotōng biāozhì • road signs



禁行
jinxíng
no entry



限速
xiànsù
speed limit



危险
wēixiǎn
hazard



禁止停车
jìnzhǐ tíngchē
no stopping



禁止右转
jìnzhǐ yòuzhuǎn
no right turn

公共汽车 gōnggòngqìchē • bus



车门 chēmén | door

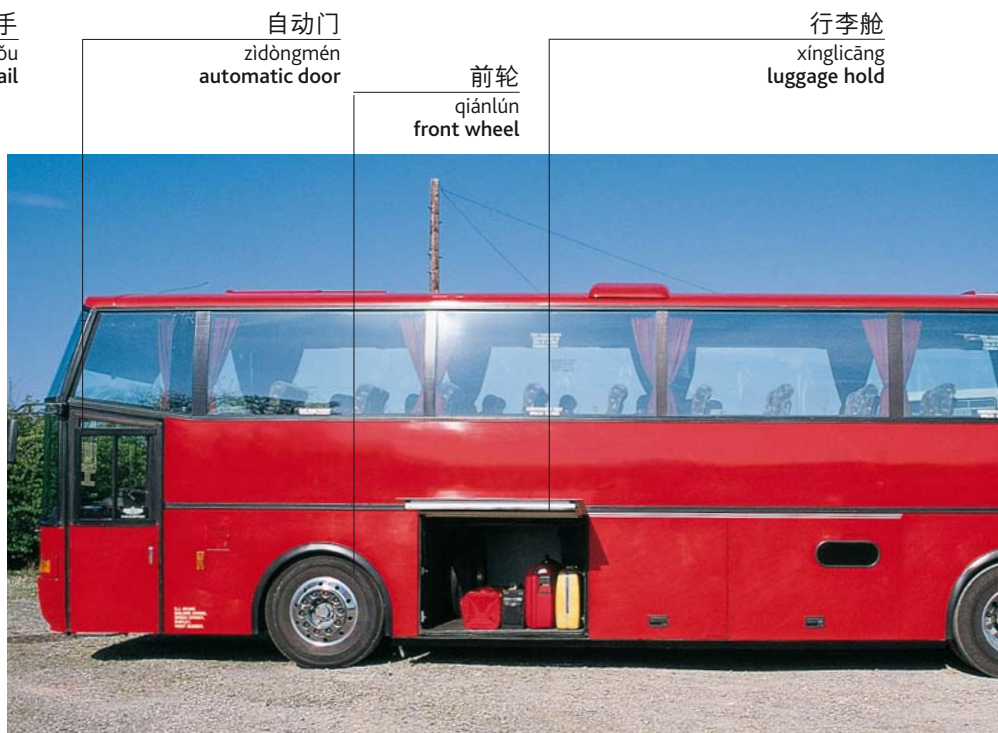

长途汽车 chángtúqìchē | coach

公共汽车种类 gōnggòngqìchē zhǒnglèi • types of buses



双层公共汽车
shuāngcéng gōnggòngqìchē
double-decker bus

公交线路号
gōngjiāoxiànlùhào
route number

司机
sījī
driver



有轨电车
yǒuguǐdiànchē
tram



无轨电车
wúguǐdiànchē
trolley bus



校车 xiàochē | school bus



后轮
hòulún
rear wheel

窗户
chuānghù
window

停车按钮
tíngchē ànniǔ
stop button



公共汽车票
gōnggòngqìchēpiào
bus ticket



铃
líng
bell



公共汽车站
gōnggòngqìchēzhàn
bus stop



公共汽车总站
gōnggòngqìchē zǒngzhàn
bus station

词汇 cíhuì • vocabulary

车费
chēfèi
fare

时刻表
shíkèbiǎo
timetable

您在... 停吗？
nín zài... tíng ma?
Do you stop at...?

轮椅通道
lúnǚ tōngdào
wheelchair access

公共汽车候车亭
gōnggòngqìchē hòuchēting
bus shelter

哪路车去...？
nǎlù chē qù...?
Which bus goes to...?



小型公共汽车
xiǎoxíng gōnggòngqìchē
minibus



游览车 yóulǎnchē | tourist bus



班车 bānchē | shuttle bus

汽车1 qìchēyī • car 1

外部 wàibù • exterior

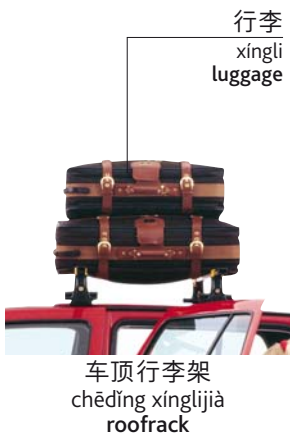
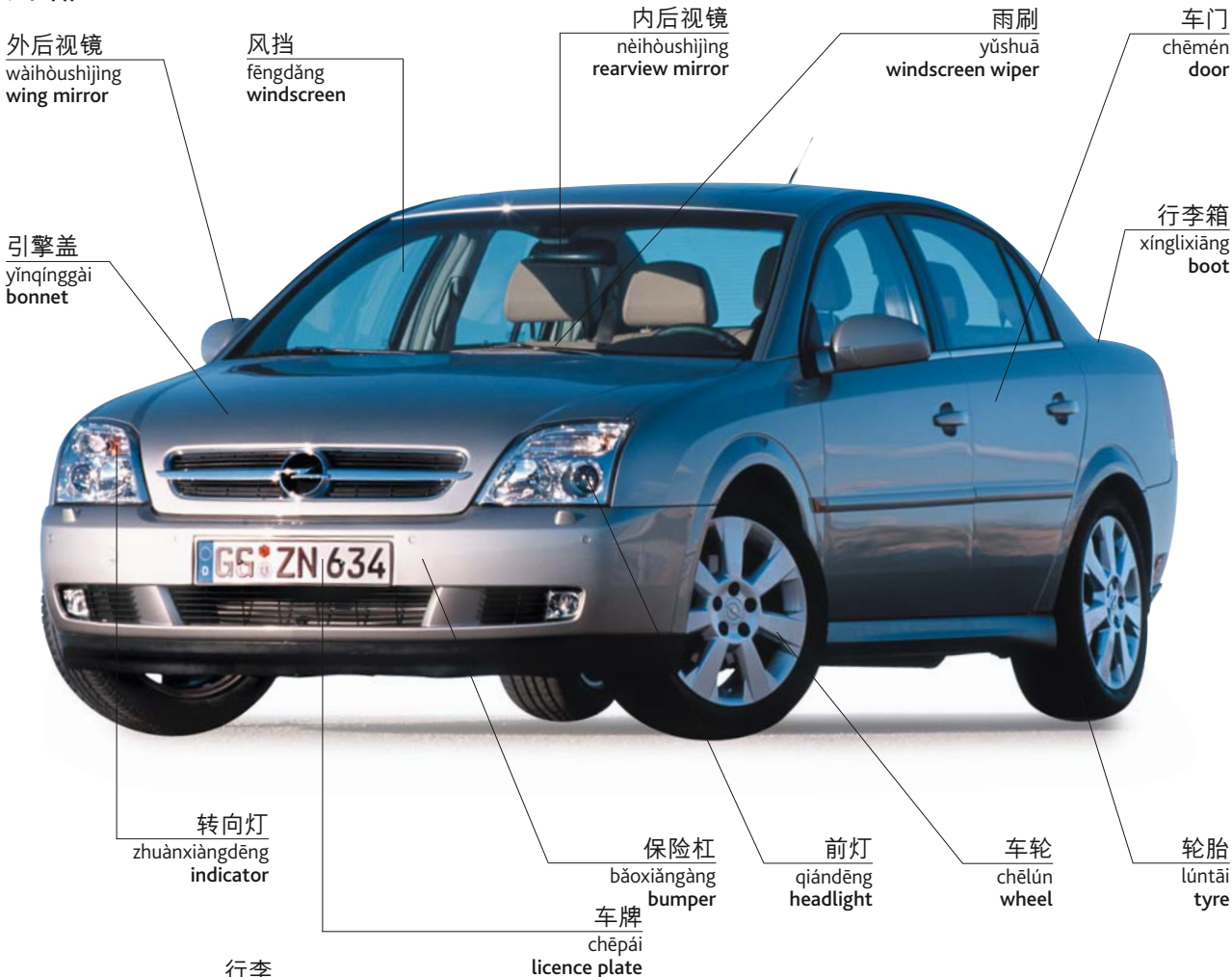

种类 zhǒnglèi • types



微型车
wēixíngchē
small car



揭背式轿车
jiēbèishì jiàochē
hatchback



家庭轿车，三厢车
jiāting jiàochē, sānxiāngchē
saloon



客货两用车
kèhuò liǎngyòngchē
estate



敞篷车
chǎngpéngchē
convertible



跑车
pǎochē
sports car



六座厢式车
liùzuò xiāngshìchē
people carrier



四轮驱动(车)
sìlúnqūdòng(chē)
four-wheel drive

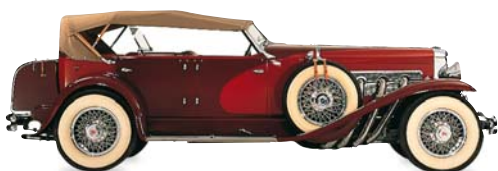

老式汽车
lǎoshìqìchē
vintage



大型高级轿车
dàxínggāojí jiàochē
limousine

加油站 jiāyóuzhàn • petrol station

汽油泵
qìyóubèng
petrol pump

价格
jiàgé
price

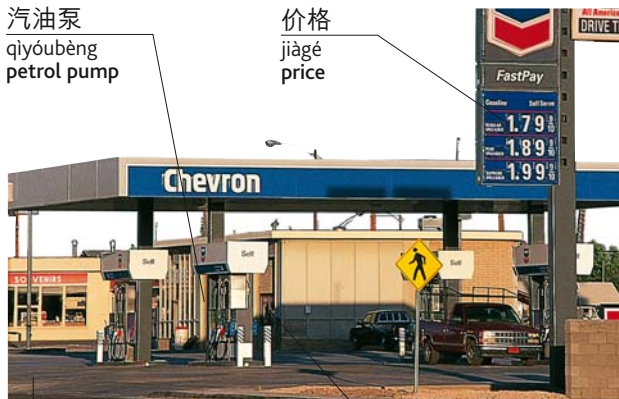

加油处
jiāyóuchù
forecourt

轮胎充气机
lúntāi chōngqìjī
air supply

词汇 cíhuì • vocabulary

油
yóu
oil

含铅
hánqiān
leaded

自动洗车站
zìdòngxǐ chēzhàn
car wash

汽油
qìyóu
petrol

柴油
cháiyou
diesel

防冻液
fángdòngyè
antifreeze

无铅
wúqiān
unleaded

汽车修理站
qìchē xiūlǐzhàn
garage

喷水器
pēnshuǐqì
screenwash

请加满油。
qǐng jiāmǎn yóu.
Fill the tank, please.

汽车 2 qìchē'èr • car 2

内部 nèibù • interior



词汇 cíhuì • vocabulary

双门
shuāngmén
two-door

四门
sìmén
four-door

自动
zìdòng
automatic

刹车
shāchē
brake

加速器，油门
jiāsùqì, yóumén
accelerator

三门
sānmén
three-door

手动
shǒudòng
manual

点火
diǎnhuǒ
ignition

离合器
líhéqì
clutch

空调
kōngtiáo
air conditioning

您能告诉我去...的路吗？
nín néng gàosù wǒ qù...de lù ma?
Can you tell me the way to...?

停车场在哪里？
tíngchēchǎng zài nǎlǐ?
Where is the car park?

这儿可以停车吗？
zhè'ér kěyǐ tíngchē ma?
Can I park here?

操作装置 cāozuòzhuāngzhì • controls

方向盘
fāngxiàngpán
steering
wheel

喇叭
lǎba
horn

仪表盘
yíbiǎopán
dashboard

警示灯
jǐngshìdēng
hazard lights

卫星导航仪
wèixīng dǎohángyí
satellite navigation



左侧驾驶 zuǒcèjiàshǐ | left-hand drive

温度计
wēndùjì
temperature gauge

转速表
zhuànsùbiǎo
rev counter

车速表
chēsùbiǎo
speedometer

油量表
yóuliàngbiǎo
fuel gauge

汽车音响
qìchē
yīnxiǎng
car stereo

车灯开关
chēdēng kāiguān
lights switch

暖风开关
nuǎfēng kāiguān
heater controls

里程表
lǐchéngbiǎo
odometer

变速杆
biànsùgǎn
gearstick

安全气囊
ānquánqìnáng
air bag



右侧驾驶 yòucèjiàshǐ | right-hand drive

汽车 3 qìchēsān • car 3

机械构造 jīxiègòuzào • mechanics

挡风玻璃清洗剂容器
dǎngfēng bōlǐ qīngxǐjī róngqì
screen wash reservoir

量油计
liàngyóujì
dipstick

空气过滤器
kōngqìguòlǜqì
air filter

制动液容器
zhìdòngyè róngqì
brake fluid reservoir

电池
diànchí
battery



车身
chēshēn
bodywork

冷却剂容器
lěngquējì róngqì
coolant reservoir

汽缸盖
qìgānggài
cylinder head

水管
shuǐguǎn
pipe

天窗
tiānchuāng
sunroof

散热器
sǎnrèqì
radiator

风扇
fēngshàn
fan

发动机, 引擎
fādòngjī, yǐnqīng
engine

轮毂盖
lúnǚgài
hubcap

变速箱
biànsùxiāng
gearbox

传动装置
chuándòng zhuāngzhì
transmission

驱动轴
qūdòngzhóu
driveshaft

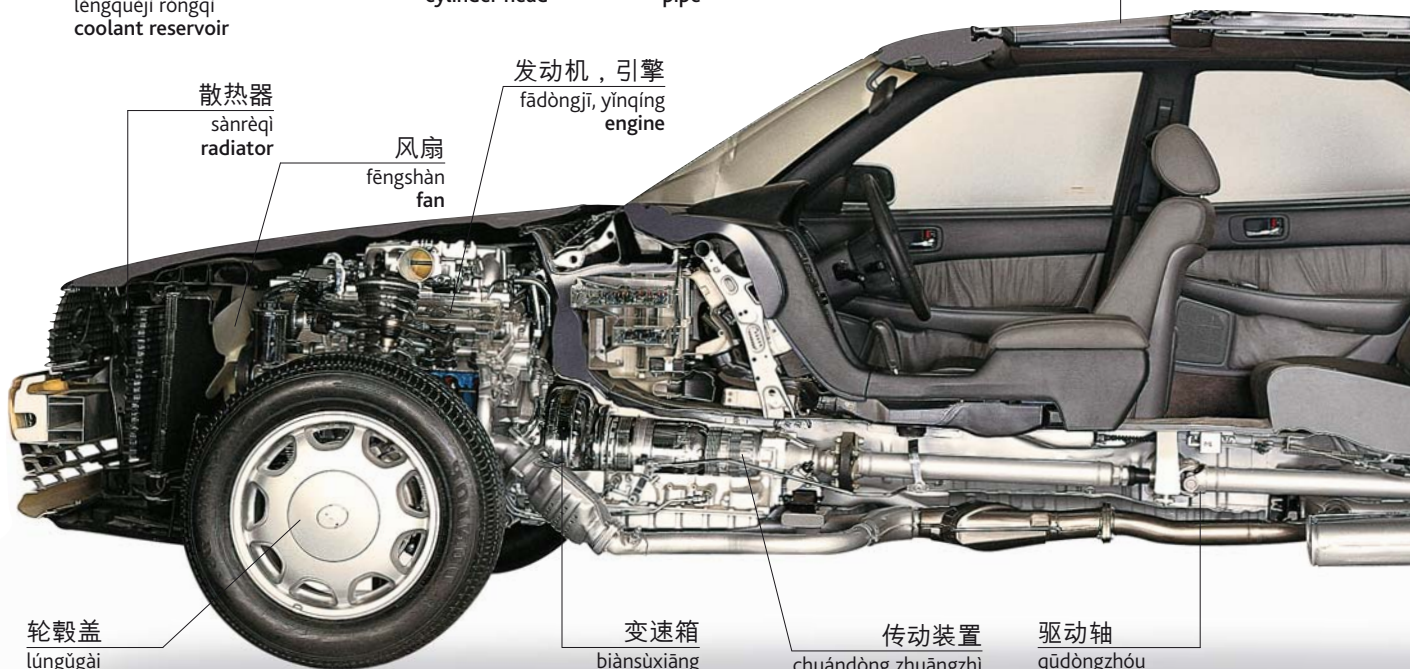

爆胎 bàotāi • puncture

备用轮胎
bèiyòng lúntāi
spare tyre

曲柄
qūbǐng
wrench

固定螺母
gùdìngluómǔ
wheel nuts

千斤顶
qiānjīndǐng
jack

更换轮胎
gēnghuàn lúntāi
change a wheel (v)

车顶
chēdǐng
roof

汽车悬架
qìchēxuánjià
suspension

排气消音器
páiqìxiāoyīnqì
silencer

排气管
páiqìguǎn
exhaust pipe

词汇 cíhuì • vocabulary

车祸
chēhuò
car accident

故障
gùzhàng
breakdown

保险
bǎoxiǎn
insurance

拖车
tuōchē
tow truck

机械师
jīxièshī
mechanic

胎压
tāiyā
tyre pressure

保险盒
bǎoxiǎnhé
fuse box

火花塞
huǒhuāsāi
spark plug

风扇皮带
fēngshàn pídài
fan belt

油箱
yóuxiāng
petrol tank

点火定时
diǎnhuǒdìngshí
timing

涡轮增压器
wōlúnzēngyāqì
turbocharger

配电器
pèidiànqì
distributor

底盘
dǐpán
chassis

手刹车
shǒushāchē
handbrake

交流发电机
jiāoliúfādiànjī
alternator

轮轴皮带
lúnzhóupídài
cam belt

我的车坏了。
wǒ de chē huàile.
I've broken down.

我的车发动不起来。
wǒ de chē fādòng bù qǐlái.
My car won't start.

您修车吗？
nín xiūchē ma
Do you do repairs?

发动机过热。
fā dòng jī guò rè
The engine is overheating

摩托车 mótuōchē • motorbike

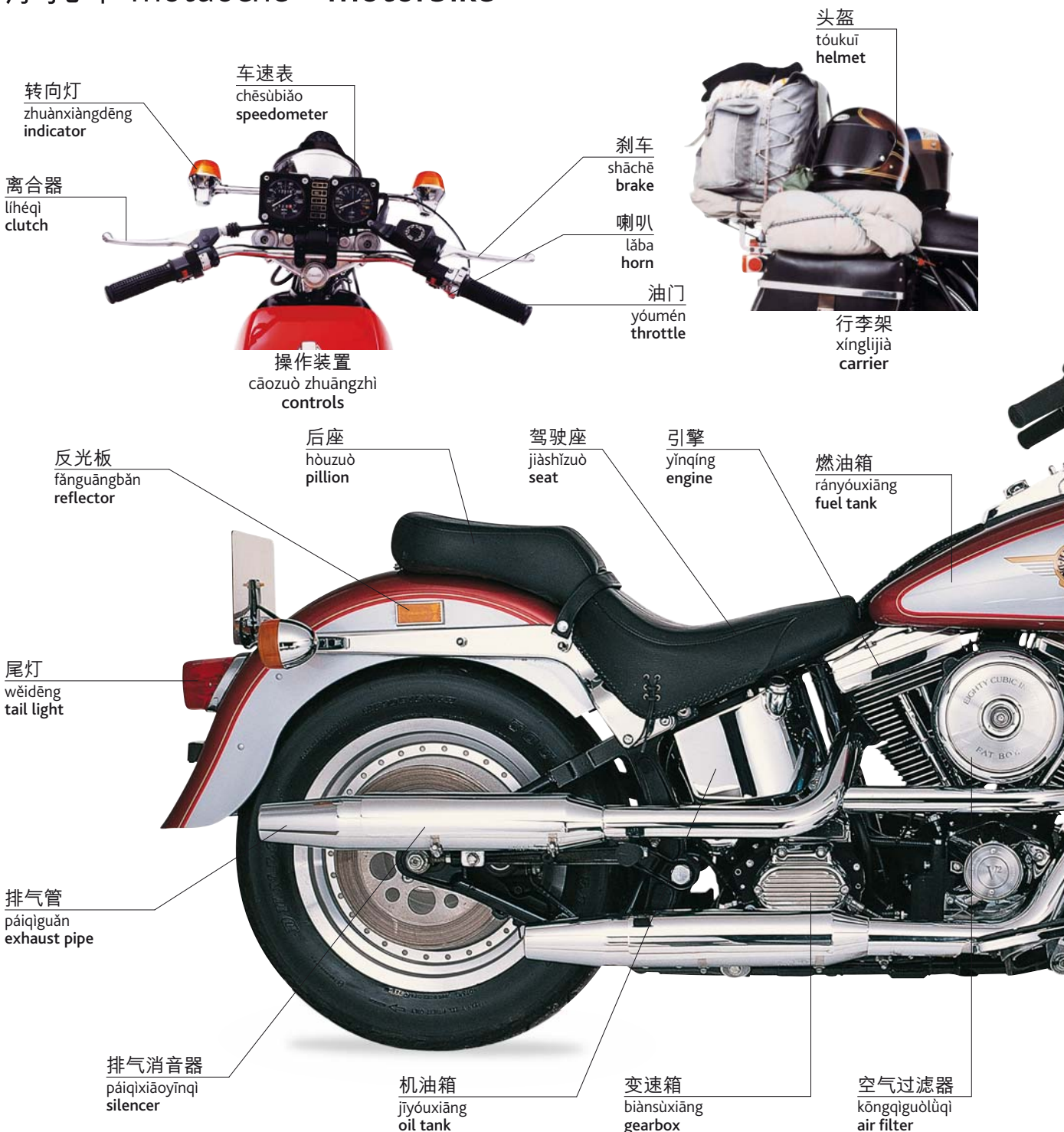

种类 zhǒnglèi • types

头盔面罩
tóukuīmiànzhào
visor

反光肩带
fǎnguāng jiāndài
reflector strap

皮衣
piyī
leathers

护膝
hùxī
knee pad

服装 fúzhuāng | clothing

前灯
qiándēng
headlight

减震器
jiǎnzhènqì
suspension

挡泥板
dǎngníbǎn
mudguard

刹车踏板
shāchētābǎn
brake pedal

轮轴
lúnzhóu
axle

轮胎
lúntāi
tyre



赛车 sàichē | racing bike

风挡
fēngdǎng
windshield



旅行摩托 lǚxíngmótuō | tourer



越野摩托 yuèyěmótuō | dirt bike

支架
zhījià
stand



小轮摩托 xiǎolúnmótuō | scooter

自行车 zìxíngchē • bicycle



双座自行车 shuāngzuò zìxíngchē
tandem



赛车 sàichē
racing bike



山地车 shāndìchē
mountain bike



旅行车 lǚxíngchē
touring bike



公路车 gōnglùchē
road bike

车座
chēzuò
saddle

座杆
zuògǎn
seat post

车架
chējià
frame

水瓶
shuǐpíng
water bottle

刹车
shāchē
brake

轮毂
lúngǔ
hub

齿轮
chǐlún
gears

轮圈
lúnquān
rim

轮胎
lúntāi
tyre

车链
chēliàn
chain

脚蹬
jiǎodēng
pedal

链盘
liànpán
cog

头盔
tóukuī
helmet



自行车道 zìxíngchēdào | cycle lane



词汇 cíhuì • vocabulary

车灯 chēdēng lamp	支架 zhījià kickstand	刹车片 shāchēpiàn brake block	车筐 chēkuāng basket	脚踏套 tàjiǎotào toe clip	刹车 shāchē brake (v)
尾灯 wěidēng rear light	自行车支架 zìxíngchē zhījià bike rack	绳索 shéngsuǒ cable	发电机 fādiànjī dynamo	趾带 zhǐdài toe strap	骑车 qíchē cycle (v)
反光镜 fǎnguāngjìng reflector	稳定轮 wēndìnglún stabilisers	扣链齿 kòuliànchǐ sprocket	爆胎 bàotāi puncture	蹬踏 dēngtà pedal (v)	变速 biànsù change gear (v)

列车 lièchē • train

客车厢
kèchēxiāng
carriage

站台
zhàntái
platform

手推车
shǒutuīchē
trolley



站台号
zhàntáihào
platform number

旅客
lǚkè
commuter

火车站 huǒchēzhàn | train station

列车种类 lièchē zhǒnglèi • types of train



蒸汽机车
zhēngqìjīchē
steam train



柴油机车 cháiyoujīchē | diesel train

火车头
huǒchētóu
engine

驾驶室
jiàshǐshì
driver's cab

铁轨
tiěguǐ
rail



电力机车
diànlìjīchē
electric train



高速列车
gāosùlièchē
high-speed train



单轨列车
dānguǐlièchē
monorail



地铁
dìtiě
underground train



有轨电车
yǒuguǐdiànchē
tram



货车
huòchē
freight train



行李架
xínglijia
luggage rack

车窗
chēchuāng
window

轨道
guǐdào
track

门
mén
door

座位
zuòwèi
seat



检票口 jiǎnpiàokou | ticket barrier

车厢隔间
chēxiānggéjiān
compartment

扩音器
kuòyīnqì
public address system

列车时刻表
lièchē shíkèbiǎo
timetable



车票
chēpiào
ticket



餐车 cānchē | dining car



车站大厅 chēzhàn dàtīng | concourse



卧铺车厢
wòpùchēxiāng
sleeping compartment

词汇 cíhuì • vocabulary

铁路网
tiělùwǎng
rail network

地铁线路图
dìtiě xiànlùtú
underground map

售票处
shòupiàochù
ticket office

接触轨
jiēchùguǐ
live rail

城际列车
chéngjì lièchē
inter-city train

晚点
wǎndiǎn
delay

检票员
jiǎnpiàoyuán
ticket inspector

信号
xìnhào
signal

上下班高峰期
shàngxiàbān gāofēngqī
rush hour

车费
chēfèi
fare

换乘
huànchéng
change (v)

紧急刹车闸
jǐnjǐ shāchēzhā
emergency lever

飞机 fēijī • aircraft

班机 bānjī • airliner



机舱 jīcāng • cabin





热气球
rèqìqiú
hot-air balloon



动力滑翔机
dònglì huáxiángjī
microlight



滑翔机
huáxiángjī
glider



双翼飞机
shuāngyì fēijī
biplane

螺旋桨
luóxuánjiǎng
propeller



轻型飞机
qīngxíng fēijī
light aircraft



水上飞机
shuǐshàng fēijī
sea plane



私人喷气式飞机
sīrén pēnqìshì fēijī
private jet

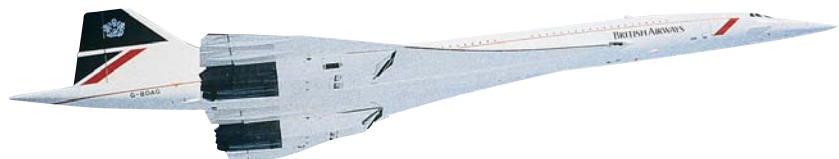

超音速飞机
chāoyīnsù fēijī
supersonic jet

旋翼
xuányì
rotor blade



直升飞机
zhíshēng fēijī
helicopter



轰炸机
hōngzhàjī
bomber

导弹
dǎodàn
missile



战斗机
zhàndòujī
fighter plane

词汇 cíhuì • vocabulary

飞行员
fēixíngyuán
pilot

起飞
qǐfēi
take off (v)

着陆
zhuólù
land (v)

经济舱
jīngjìcāng
economy class

手提行李
shǒutíxínglǐ
hand luggage

副驾驶员
fùjiàshìyuán
co-pilot

飞行
fēixíng
fly (v)

高度
gāodù
altitude

商务舱
shāngwùcāng
business class

安全带
ānquándài
seat belt

机场 jīchǎng • airport



班机 bānji | airliner

停机坪
tíngjīpíng
apron

行李拖车
xínglituōchē
baggage trailer

候机楼
hòujīlóu
terminal

服务车
fúwùchē
service vehicle

登机通道
dēngjītōngdào
walkway

词汇 cíhuì • vocabulary

跑道
pǎodào
runway

航班号
hángbānhào
flight number

行李传送带
xíngli chuánsòngdài
carousel

假日
jiàrì
holiday

国际航线
guójí hángxiàn
international flight

入境检查
rùjìngjiǎnchá
immigration

安全
ānquán
security

办理登机手续
bànlǐ dēngjī shǒuxù
check in (v)

国内航线
guónèi hángxiàn
domestic flight

海关
hǎiguān
customs

X光行李检查机
Xguāng xíngli jiǎncháji
X-ray machine

控制塔
kòngzhìtǎ
control tower

联运
liányùn
connection

超重行李
chāozhòng xíngli
excess baggage

假日指南
jiàrì zhǐnán
holiday brochure

订机票
dìngjīpiào
book a flight (v)

手提行李
shǒutí xíngli
hand luggage

(大件)行李
(dàjiàn) xíngli
luggage

行李推车
xíngli tuīchē
trolley



办理登机手续处
bànlǐ dēngjī shǒuxùchù
check-in desk



签证
qiānzhèng
visa

护照 hùzhào | passport

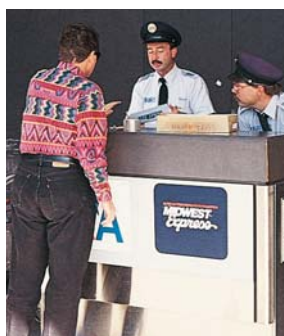

护照检查处
hùzhào jiǎncháchù
passport control

登机牌
dēngjīpái
boarding pass



机票
jīpiào
ticket



候机大厅
hòujīdàtīng
departure lounge

登机门号
dēngjīménhào
gate number

出发
chūfā
departures



目的地
mùdìdì
destination

信息屏
xìnxíng
information screen

抵达
dīdá
arrivals



免税商店
miǎnshuì shāngdiàn
duty-free shop



领取行李处
lǐngqǔ xínglichù
baggage reclaim



出租车站
chūzūchēzhàn
taxi rank



租车处
zūchēchù
car hire

船 chuán • ship

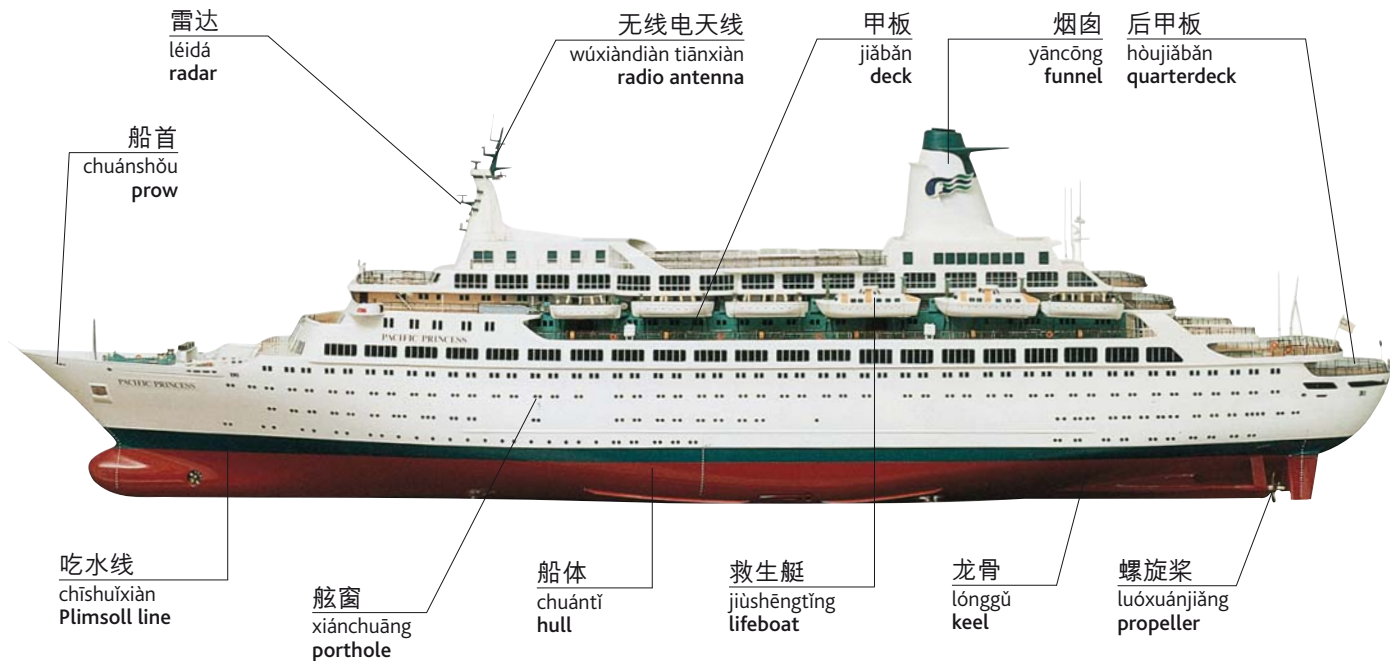

远洋客轮 yuǎnyángkèlún | ocean liner



驾驶台 jiàoshǐtái
bridge



轮机舱 lúnjīcāng
engine room



客舱 kècāng
cabin



船上厨房 chuánshàng chúfáng
galley

词汇 cíhuì • vocabulary

船坞 chuánwù
dock

港口 gǎngkǒu
port

舷梯 xiántī
gangway

锚 máo
anchor

岸边缆桩 ànbīanlǎnzhuāng
bollard

卷扬机 juǎnyángjī
windlass

船长 chuánzhǎng
captain

快艇 kuàitǐng
speedboat

划桨船 huájiǎngchuán
rowing boat

独木舟 dúmùzhōu
canoe

其他船型 qítāchuánxíng • other ships



渡船
dùchuán
ferry



舷外马达
xiánwàimǎdǎ
outboard motor

充气式橡皮艇
chōngqìshì xiàngpítíng
inflatable dinghy



水翼艇
shuǐyǐtíng
hydrofoil



游艇
yóutíng
yacht



双体船
shuāngtǐchuán
catamaran



拖船
tuōchuán
tug boat



气垫船
qìdiànchuán
hovercraft



集装箱船
jízhuāngxiāng chuán
container ship

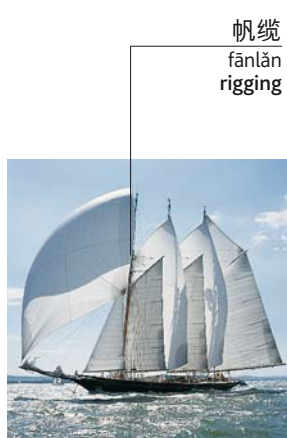

帆缆
fānlǎn
rigging

帆船
fānchuán
sailboat

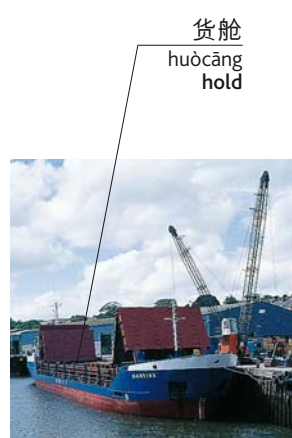

货舱
huòcāng
hold

货船
huòchuán
freighter



油轮
yóulún
oil tanker



航空母舰
hángkōng mǔjiàn
aircraft carrier



战舰
zhànjiàn
battleship



指挥塔
zhǐhuītǎ
conning tower

潜水艇
qiánshuǐtíng
submarine

港口 gǎngkǒu • port

仓库
cāngkù
warehouse

起重机
qǐzhòngjī
crane

叉车
chāchē
fork-lift truck

出入港通道
chūrùgǎng tōngdào
access road

海关
hǎiguān
customs house



船坞
chuánwù
dock

集装箱
jízhuāngxiāng
container

码头
mǎtóu
quay

货物
huòwù
cargo



集装箱港口 jízhuāngxiāng gǎngkǒu | container port

渡船码头
dùchuán mǎtóu
ferry terminal

渡船
dùchuán
ferry

售票处
shòupiàochù
ticket office

乘客
chéngkè
passenger



客运码头 kèyùn mǎtóu | passenger port

渔网
yúwǎng
net

渔船
yúchuán
fishing boat

缆绳
lǎnshéng
mooring



渔港 yúgǎng | fishing port



小船停靠区 xiǎochuántíngkàoqū | marina



港口 gǎngkǒu | harbour



栈桥 zhànqiáo | pier



防波堤 fángbōdī
jetty



船厂 chuánchǎng
shipyard



灯塔 dēngtǎ
lighthouse

塔灯
tǎdēng
lamp



浮标 fúbiāo
buoy

词汇 cíhuì • vocabulary

海岸警卫队
hǎi'àn jǐngwèidui
coastguard

港务局长
gǎngwù júzhǎng
harbour master

抛锚
pāomáo
drop anchor (v)

干船坞
gānchuánwù
dry dock

停泊
tíngbó
moor (v)

进入船坞
jìnrùchuánwù
dock (v)

上船
shàngchuán
board (v)

离船登岸
líchuándēng'àn
disembark (v)

起航
qǐháng
set sail (v)



体育运动 tǐyù yùndòng
sports

美式橄榄球 měishì gǎnlǎnqiú • American football

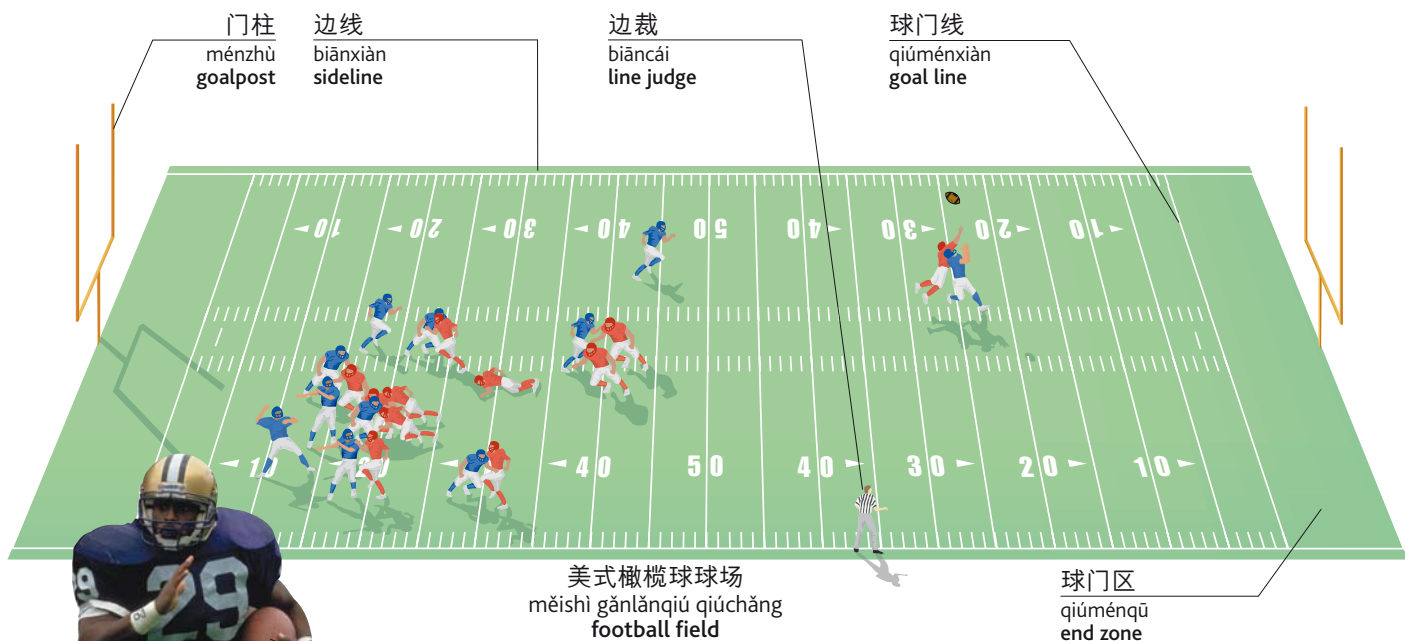

球员 qiúyuán football player

橄榄球 gǎnlǎnqiú football

球鞋 qiúxié boot

护膝 hùxī pads

头盔 tóukuī helmet



擒抱 qínbào tackle (v)



传球 chuánqiú pass (v)



接球 jiēqiú catch (v)

词汇 cíhuì • vocabulary

暂停 zàntíng
time out

球队 qiúduì
team

防守 fángshǒu
defence

啦啦队长 lālādúicháng
cheerleader

几比几? jǐbǐjǐ?
What is the score?

漏接 lòujiē
fumble

进攻 jìngōng
attack

分数 fēnshù
score

触地得分 chùdìdéfēn
touchdown

谁领先? shuí lǐngxiān?
Who is winning?

英式橄榄球 yīngshì gǎnlǎnqiú • rugby

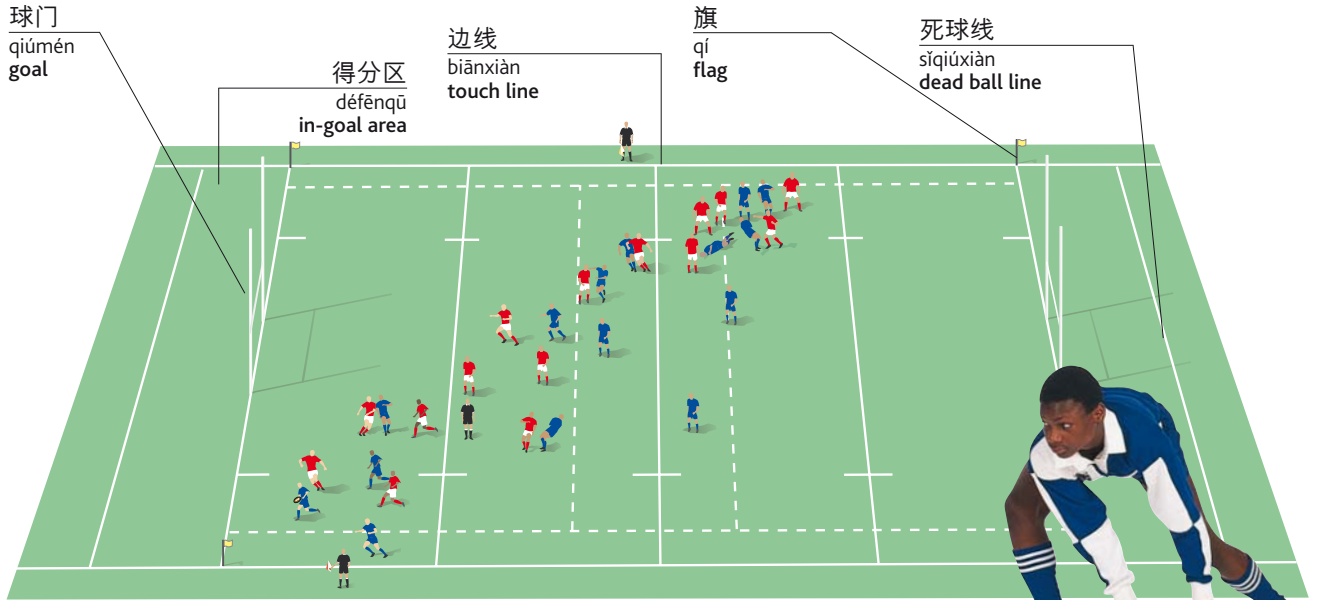

英式橄榄球场 yīngshì gǎnlǎnqiú qiúchǎng | rugby pitch



抛球 pāoqiú throw (v)

球 qiú ball



踢球 tīqiú kick (v)

(英式)橄榄球球衣 (yīngshì) gǎnlǎnqiú qiúyī rugby strip



传球 chuánqiú pass (v)



擒抱 qínbào tackle (v)



持球触地得分 chíqiú chùdìdéfēn try



密集争球 mìjī zhēngqiú | ruck

球员 qiúyuán player



并列争球 bìngliè zhēngqiú | scrum

足球 zúqiú • soccer



足球球员
zúqiú qiúyuán
footballer

足球
zúqiú
football

守门员
shǒuményuán
goalkeeper

足球球衣
zúqiú qiúyī
football strip

前锋
qiánfēng
forward

主裁判
zhǔcáipàn
referee

中圈
zhōngquān
centre circle

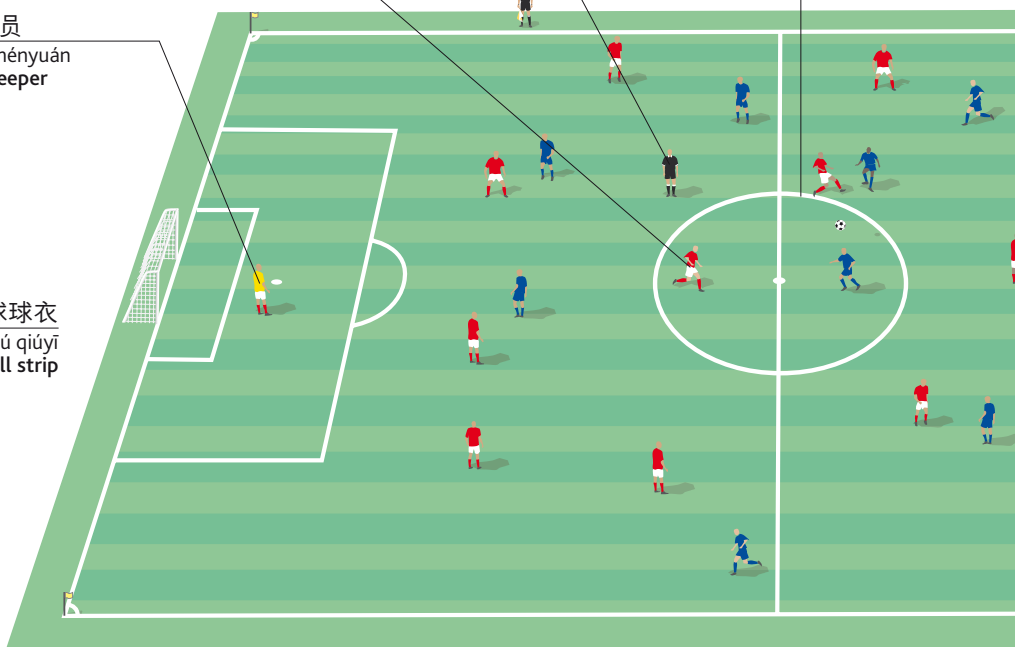

门柱
ménzhù
goalpost

球网
qiúwǎng
net

球门横梁
qiúmén héngliáng
crossbar



球门 qiúmén | goal

足球场
zúqiúchǎng
football pitch



带球 dàiqiú | dribble (v)



头球
tóuqiú
head (v)



人墙
rénqiáng
wall

任意球 rènyìqiú | free kick

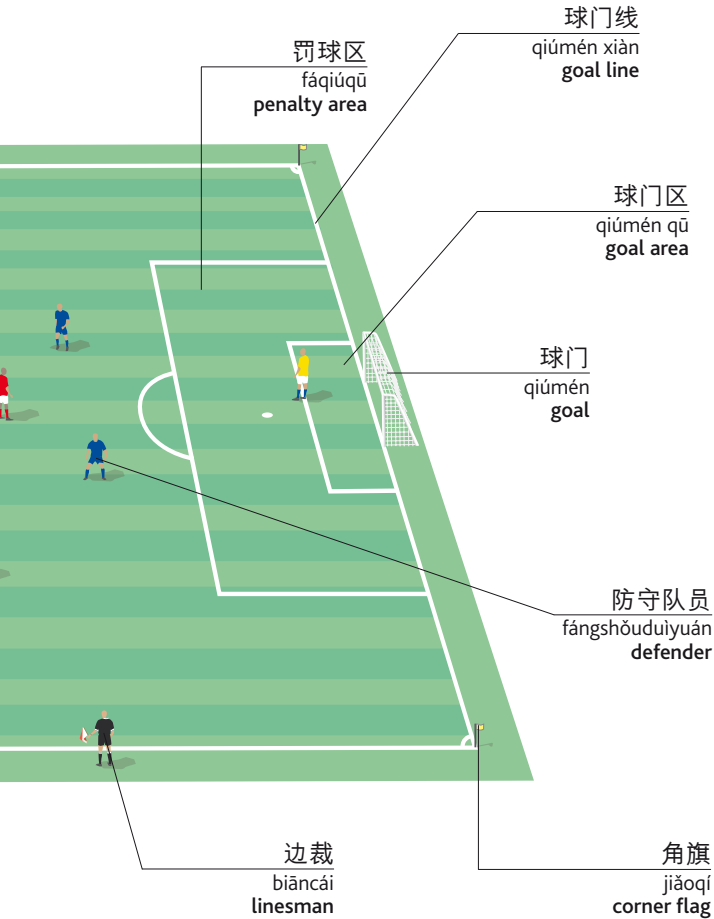

掷界外球 zhìjièwàiqiú
throw-in



踢球 tīqiú | kick (v)

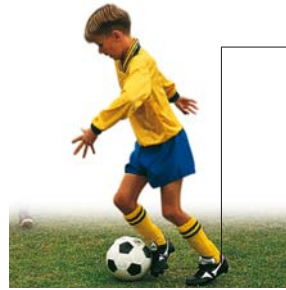

传球 chuánqiú
pass (v)



球鞋 qiúxié
boot

射门 shèmén
shoot (v)



救球 jiùqiú
save (v)

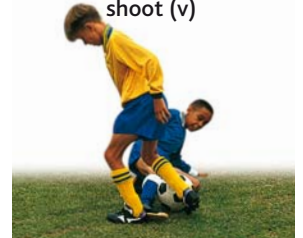

铲球 chǎnqiú
tackle (v)

词汇 cíhuì • vocabulary

体育场
tiyùchǎng
stadium

犯规
fànguī
foul

黄牌
huángpái
yellow card

联赛
liánsài
league

加时
jiāshí
extra time

进球得分
jìnqiúdéfēn
score a goal (v)

角球
jiǎoqiú
corner

越位
yuèwèi
off-side

平局
píngjú
draw

替补队员
tìbǔduìyuán
substitute

罚点球
fádiǎnqiú
penalty

红牌
hóngpái
red card

罚出场外
fáchūchǎngwài
send off

半场
bànchǎng
half time

换人
huànrén
substitution

曲棍类运动 qǔgùnlèi yùndòng • hockey

冰球 bīngqiú • ice hockey



曲棍球 qūgùnqiú • field hockey

曲棍球棒 qūgùnqiú bàng hockey stick



冰球 bīngqiú puck

冰球球员 bīngqiú qiúyuán ice hockey player



板球 bǎnqiú • cricket

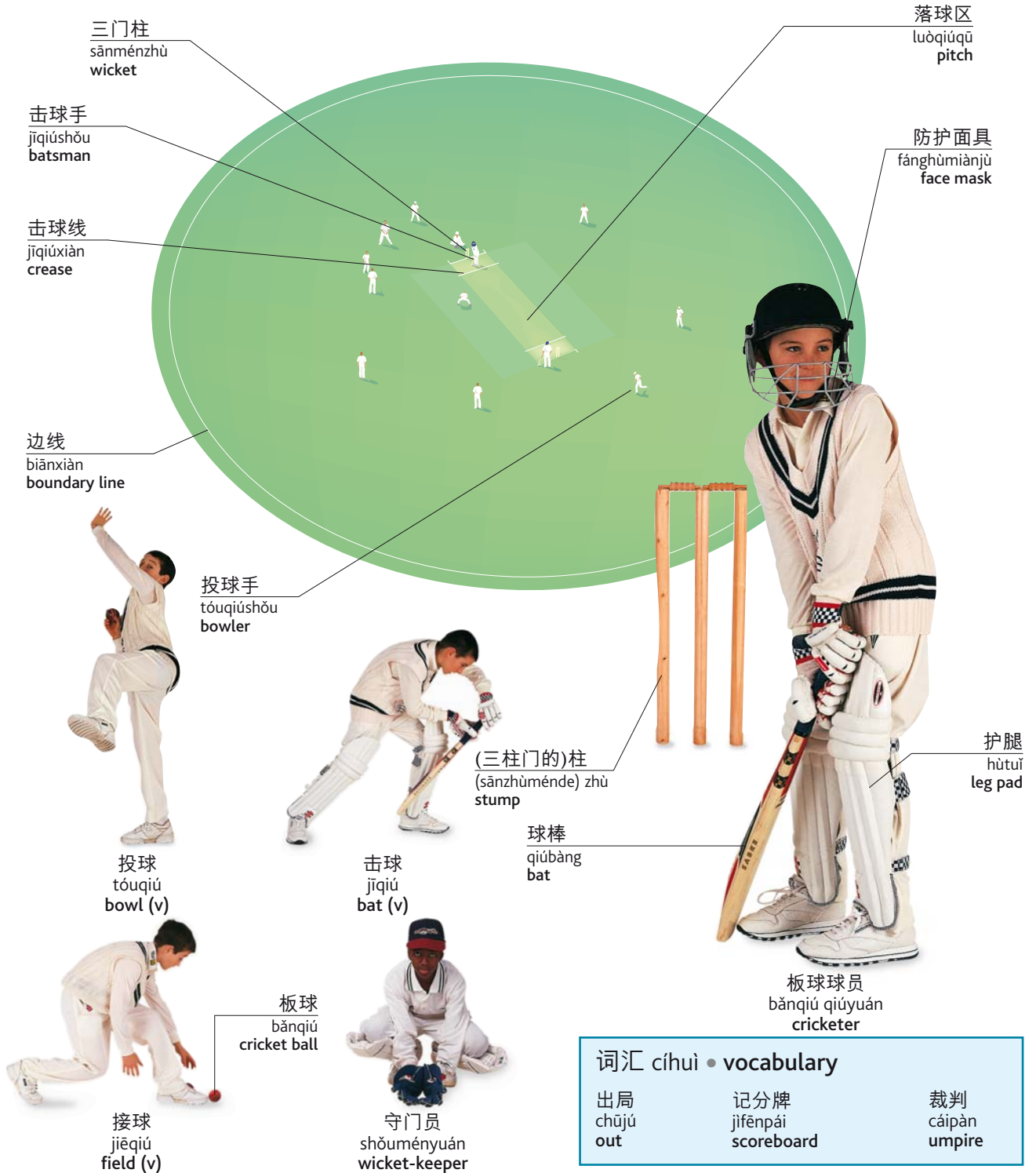

三门柱
sānménzhù
wicket

击球手
jīqiúshǒu
batsman

击球线
jīqiúxiàn
crease

边线
biānxiàn
boundary line

投球手
tóuqiúshǒu
bowler

投球
tóuqiú
bowl (v)

击球
jīqiú
bat (v)

板球
bǎnqiú
cricket ball

接球
jiēqiú
field (v)

守门员
shǒuményuán
wicket-keeper

落球区
luòqiúqū
pitch

防护面具
fánghùmiànjù
face mask

(三柱门的)柱
(sānzhùménde) zhù
stump

球棒
qiúbàng
bat

护腿
hùtuǐ
leg pad

板球球员
bǎnqiú qiúyuán
cricketer

词汇 cíhuì • vocabulary

出局
chūjú
out

记分牌
jìfēnpái
scoreboard

裁判
cáipàn
umpire

篮球 lánqiú • basketball

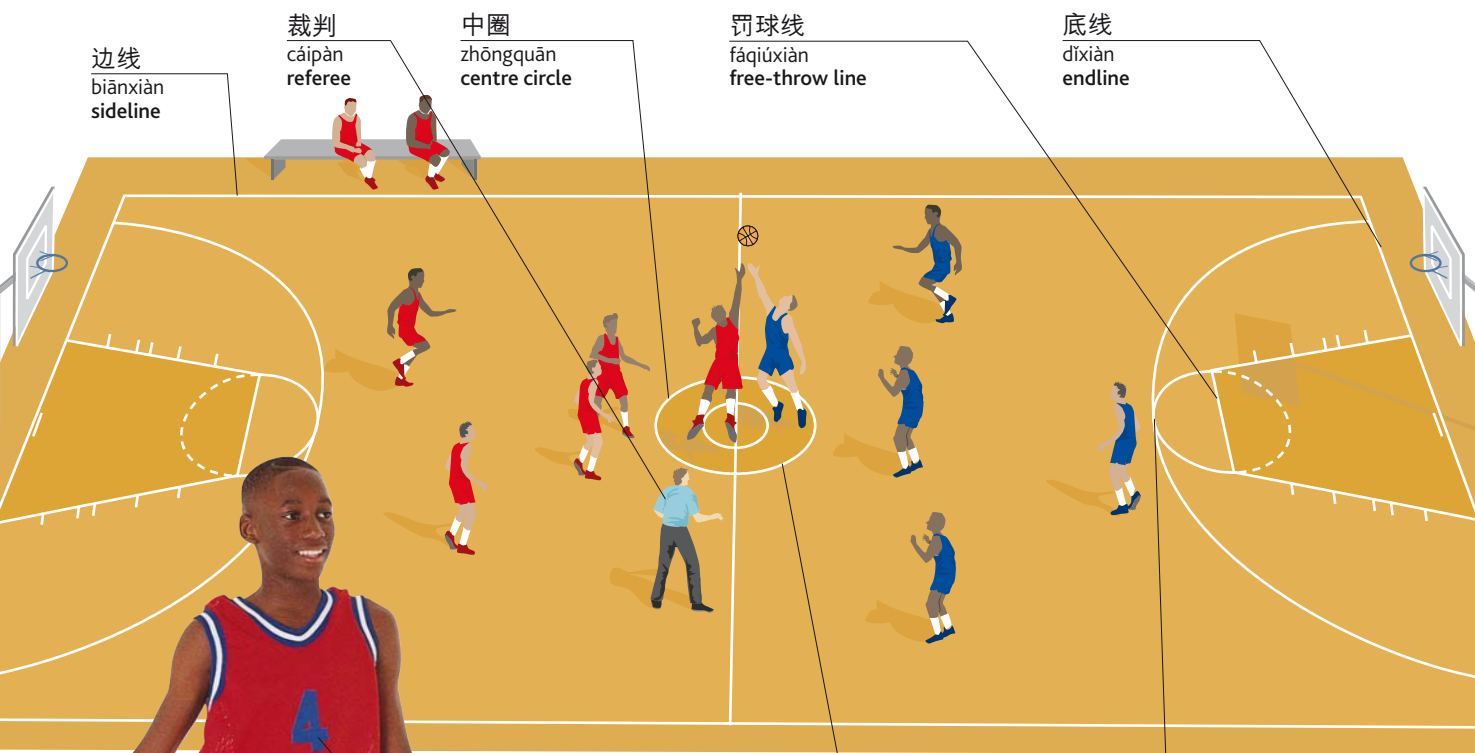

边线
biānxiàn
sideline

裁判
cáipàn
referee

中圈
zhōngquān
centre circle

罚球线
fáqiúxiàn
free-throw line

底线
dǐxiàn
endline



篮球
lánqiú
ball

球衣号
qiúyīhào
number

篮板
lánbǎn
backboard

篮圈
lánquān
hoop

球网
qiúwǎng
net

球篮
qiúlán
basket

球场 qiúchǎng | court

中线
zhōngxiàn
centreline

三分线
sānfēnxiàn
three-point line

词汇 cíhuì • vocabulary

传球
chuánqiú
pass

掷界外球
zhìjièwàiqiú
throw-in

犯规
fànguī
foul

跳球
tiàoqiú
jump ball

篮板球
lánbǎnqiú
rebound

出界
chūjiè
out of bounds

篮球球员 lánqiú qiúyuán | basketball player

动作 dòngzuò • actions



掷球
zhìqiú
throw (v)



接球
jiēqiú
catch (v)



投篮
tóulán
shoot (v)



跳投
tiàotóu
jump (v)



灌篮
guànlán
dunk (v)



盯人
dīng rén
mark (v)



阻挡
zǔdǎng
block (v)



运球
yùnqiú
bounce (v)



灌篮
guànlán
dunk (v)

排球 páiqiú • volleyball

拦网
lánwǎng
block (v)

球网
qiúwǎng
net

垫球
diànqiú
dig (v)

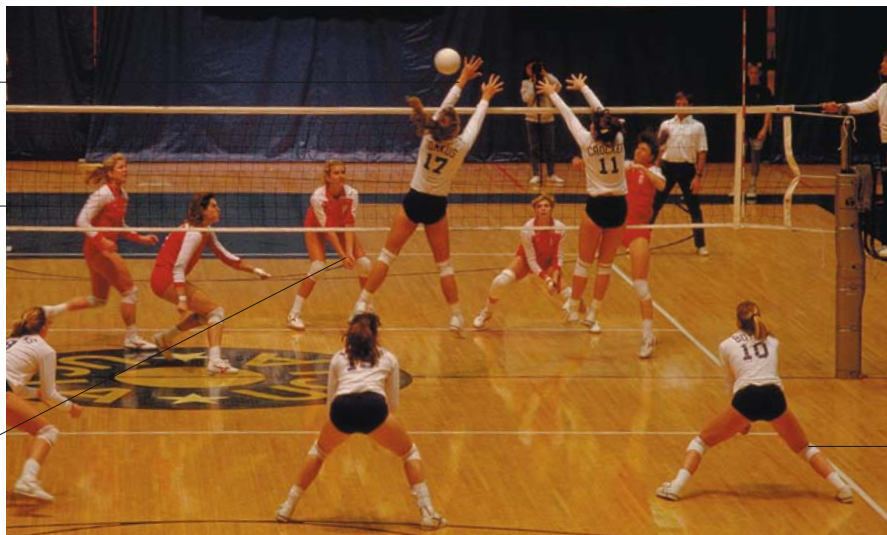

裁判
cáipàn
referee

护膝
hùxī
knee support

球场 qiúchǎng | court

棒球 bàngqiú • baseball

球场 qiúchǎng • field

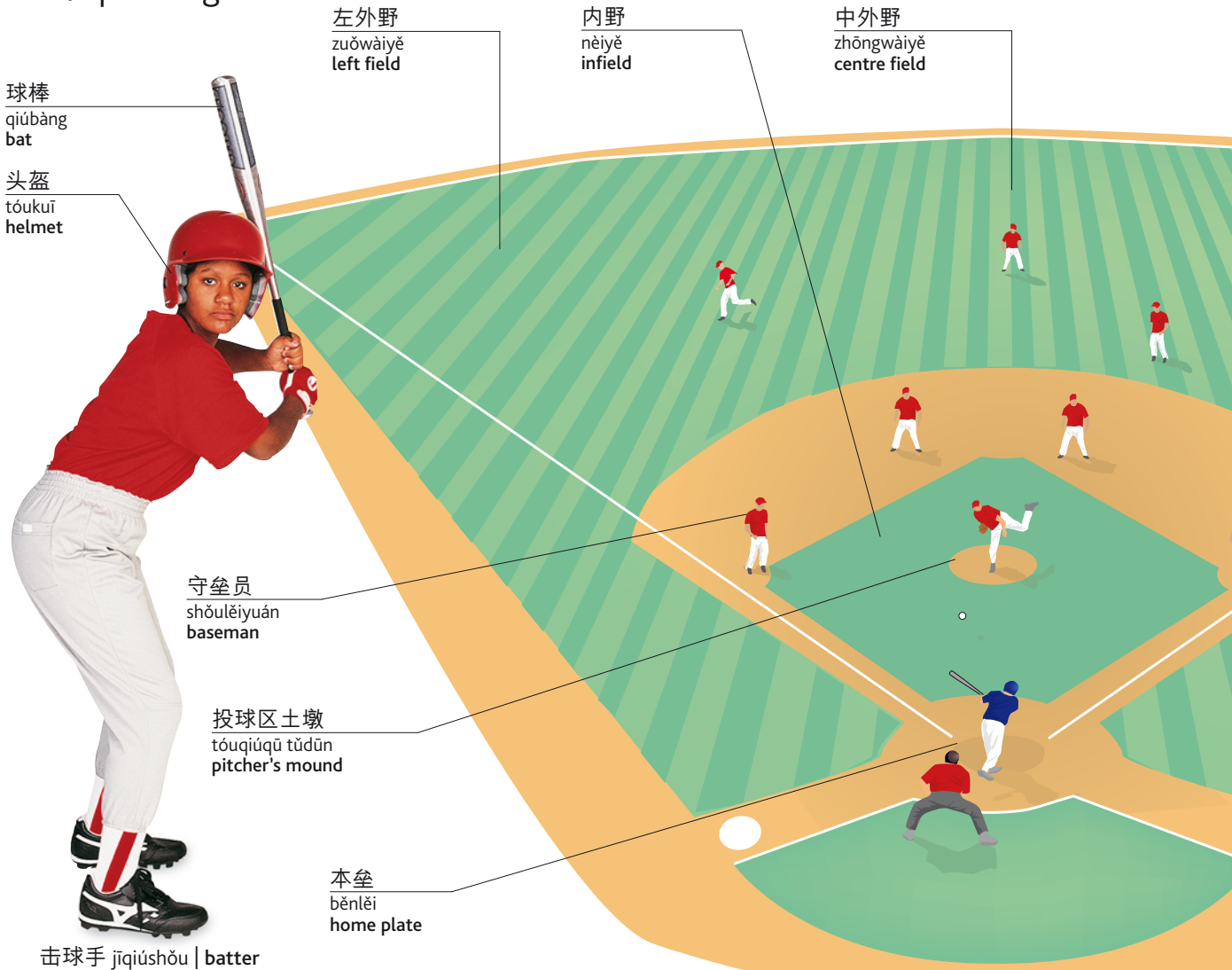

词汇 cíhuì • vocabulary

击球局
jīqiújú
inning

安全上垒
ānquánshànglěi
safe

界外球
jièwàiqiú
foul ball

得分
défēn
run

出局
chūjú
out

好球
hǎoqiú
strike



棒球手套 bàngqiú shǒutào
mitt

棒球
bàngqiú
ball



防护面具 fánghùmiànjù
mask

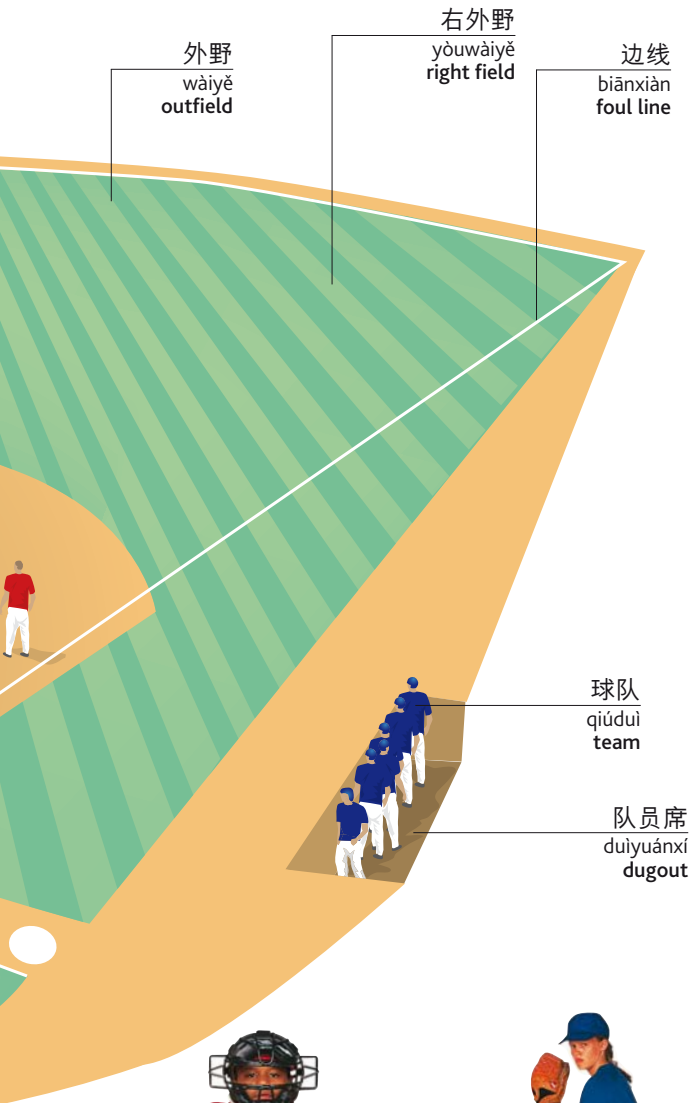

接球手 jiēqiúshǒu | catcher



投手手 tóuqiúshǒu | pitcher

动作 dòngzuò • actions



投球 tóuqiú | throw (v)



接球 jiēqiú | catch (v)



跑垒 pǎolěi
run (v)



守球 shǒuqiú | field (v)



滑垒 huálēi
slide (v)

触杀 chùshā
tag (v)

投球 tóuqiú
pitch (v)

击球 jīqiú
bat (v)

裁判 cáipàn
umpire



比赛 bǐsài | play (v)

网球 wǎngqiú • tennis

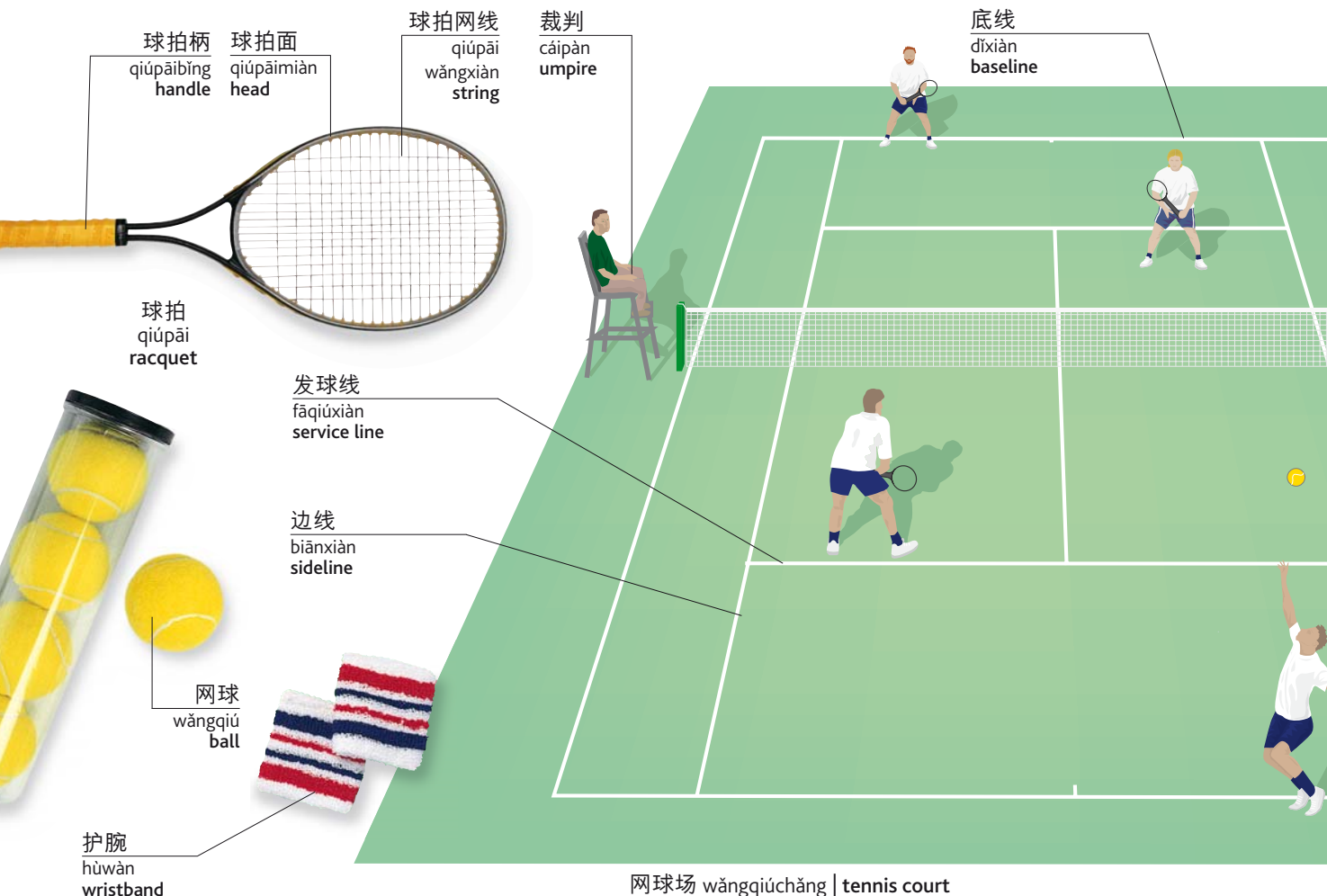

网球场 wǎngqiúchǎng | tennis court

词汇 cíhuì • vocabulary

单打
dāndǎ
singles

盘, 局
pán, jú
set

零分
língfēn
love

发球失误
fāqiúshīwù
fault

削球
xiāoqiú
slice

边裁
biāncái
linesman

双打
shuāngdǎ
doubles

比赛
bǐsài
match

评分
píngfēn
deuce

发球得分
fāqiúdéfēn
ace

回合
huíhé
rally

锦标赛
jīnbiāosài
championship

比赛
bǐsài
game

抢七局
qiǎngqījú
tiebreak

发球方占先
fāqiúfāng
zhànxiān
advantage

近网短球
jìnwǎng
duǎnqiú
dropshot

触网!
chùwǎng!
let!

(球在空中)旋转
(qiúzài kōngzhōng)
xuánzhuǎn
spin

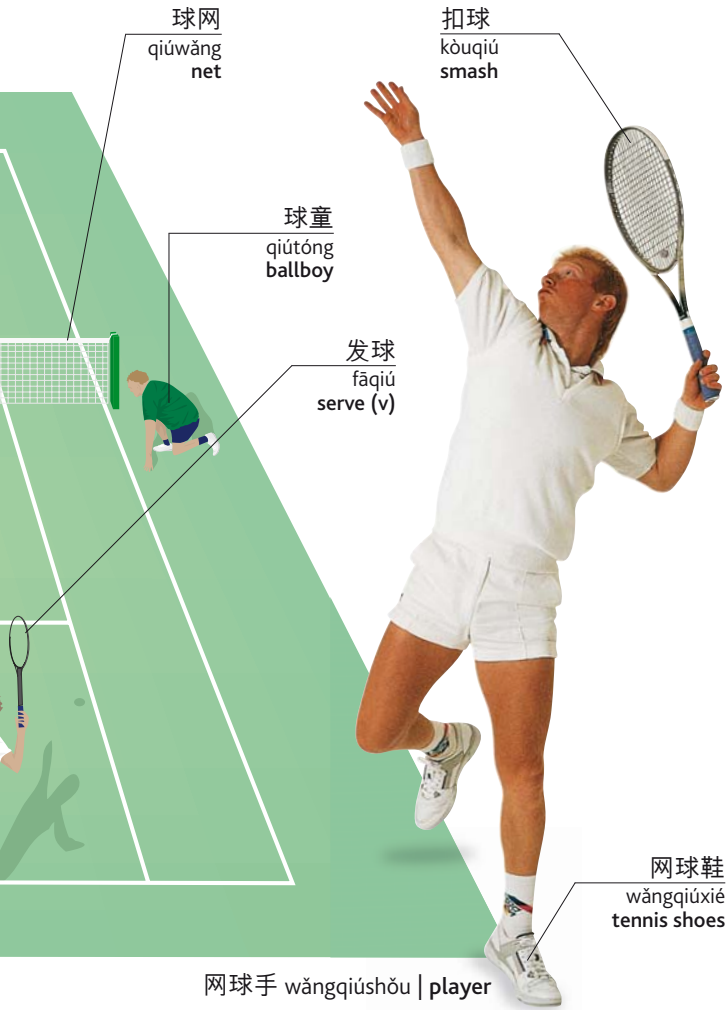

网球手 wǎngqiúshǒu | player

击球动作 jīqiúdòngzuò • strokes



发球 fāqiú serve

拦击球 lánjīqiú volley



回球 huíqiú return



吊高球 diàogāoqiú lob



正手 zhèngshǒu forehand



反手 fǎnshǒu backhand

拍类运动 pāilèi yùndòng • racquet games

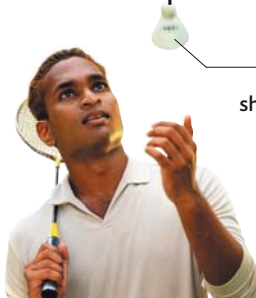

羽毛球 yǔmáoqiú shuttlecock



乒乓球拍 pīngpāngqiúpāi bat

羽毛球(运动) yǔmáoqiú (yùndòng) badminton

乒乓球 pīngpāngqiú table tennis



壁球 bìqiú squash



短拍壁球 duǎnpāibìqiú racquetball

高尔夫球 gāo'ěrfūqiú • golf



球洞
qiúdòng
hole

发球区
fāqiúqū
teeing ground

果岭
guǒlǐng
green

沙坑
shākēng
bunker

旗
qí
flag

挥杆
huīgān
swing (v)

球道
qiúdào
fairway

长草区
chángcǎoqū
rough

水障碍
shuǐzhàngài
water hazard

高尔夫球场
gāo'ěrfū qiúchǎng
golf course

短途小车
duǎntú xiǎochē
buggy

击球姿势
jīqiúzhìshì
stance

高尔夫球员 gāo'ěrfū qiúyuán | golfer

会所 huìsuǒ | clubhouse

球具 qiújù • equipment



高尔夫球杆 gāo'ěrfū qiúgān
• golf clubs



动作 dòngzuò • actions



词汇 cíhuì • vocabulary

一杆入洞
yīgān rùdòng
hole in one

标准杆数
biāozhǔn gānshù
par

差点
chàdiǎn
handicap

球童
qiútóng
caddy

向后挥杆
xiàng hòu huīgān
backswing

击球
jīqiú
stroke

低于标准杆数
dīyú biāozhǔn
gānshù
under par

高于标准杆数
gāoyú biāozhǔn
gānshù
over par

巡回赛
xúnhuísài
tournament

观众
guānzhòng
spectators

练习挥杆
liànxí huīgān
practice swing

打球线
dǎqiúxiàn
line of play

田径运动 tiánjìng yùndòng • athletics

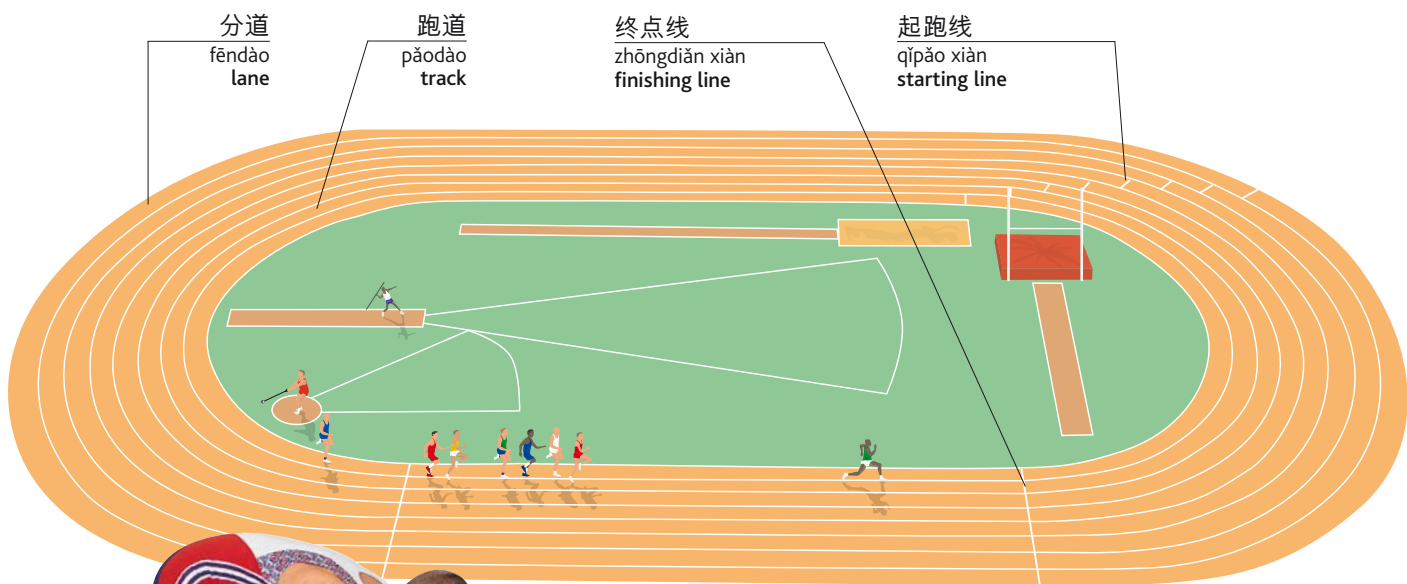

词汇 cíhuì • vocabulary

赛跑 sàipǎo race

纪录 jìlù record

终点摄影记录 zhōngdiǎn shèyǐng jìlù photo finish

撑杆跳 chēnggāntiào pole vault

时间 shíjiān time

打破纪录 dǎpò jìlù break a record (v)

马拉松 mǎlāsōng marathon

个人最好成绩 gèrén zuìhǎo chéngjì personal best



秒表 miǎobiǎo stopwatch

接力棒
jiēlibàng
baton



接力
jiēli
relay race

横杆
hénggān
crossbar



跳高
tiàogāo
high jump



跳远
tiàoyuǎn
long jump



跨栏
kuàlán
hurdles

体操 tǐcāo • gymnastics

跳板
tiàobǎn
springboard



空翻
kōngfān
somersault



垫子
diànzi
mat

自由体操
zìyóutǐcāo
floor exercises

体操选手
tǐcāo xuǎnshǒu
gymnast



平衡木 pínghéngmù | beam

丝带
sīdài
ribbon



翻筋斗
fānjīndǒu
tumble



艺术体操
yìshù tǐcāo
rhythmic gymnastics

跳马
tiàomǎ
horse



跳马(项目)
tiàomǎ (xiàngmù)
vault

词汇 cíhuì • vocabulary

单杠
dāngàng
horizontal bar

鞍马
ānmǎ
pommel horse

吊环
diàohuán
rings

奖牌
jiǎngpái
medals

银牌
yínpái
silver

双杠
shuānggàng
parallel bars

高低杠
gāodīgàng
asymmetric bars

领奖台
lǐngjiǎngtái
podium

金牌
jīnpái
gold

铜牌
tóngpái
bronze

格斗运动 gédòu yùndòng • combat sports

对手
duìshǒu
opponent

护盔
hùkuī
guard

手套
shǒutào
glove

腰带
yāodài
belt

跆拳道 táiquándào | tae-kwon-do

空手道 kōngshǒudào | karate



合气道 héqìdào | aikido

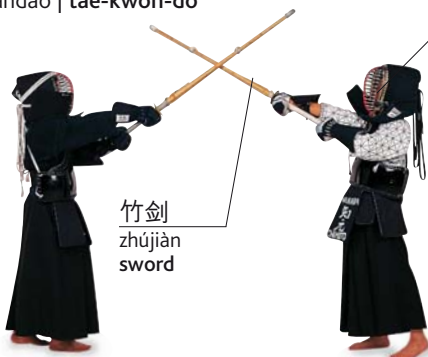

竹剑
zhújiàn
sword

剑道 jiàndào | kendo

防护面具
fánghùmiànjù
mask



柔道 róudào | judo



中国武术 zhōngguówǔshù
kung fu



泰拳 tàiquán | kickboxing

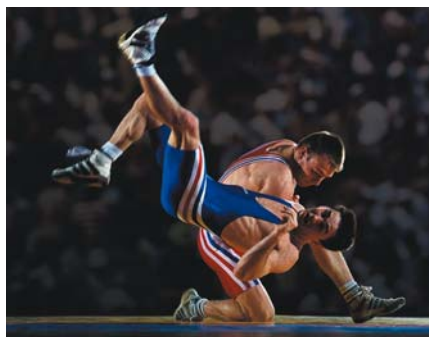

摔跤 shuāijiāo | wrestling



拳击 quánjī | boxing

动作 dòngzuò • actions



摔倒 shuāidǎo | fall



抓握 zhuāwò | hold



摔 shuāi | throw



压倒 yādǎo | pin



侧踢 cètī | kick



出拳 chūquán | punch



击打 jīdǎ | strike



劈 pī | chop



跳踢 tiàotī | jump



挡 dǎng | block

词汇 cíhuì • vocabulary

拳击台
quánjī tái
boxing ring

回合
huíhé
round

拳头
quántóu
fist

黑带
hēidài
black belt

卡波卫勒舞
kǎbōwèilèwǔ
capoeira

拳击手套
quánjī shǒutào
boxing gloves

拳击比赛
quánjī bǐsài
bout

击倒 (对手)
jīdǎo (duìshǒu)
knock out

自卫
zìwèi
self defence

相扑
xiàngpū
sumo wrestling

护齿
hùchǐ
mouth guard

拳击练习
quánjī liànxí
sparring

沙袋
shādài
punch bag

武术
wǔshù
martial arts

太极拳
tàijíquán
tai-chi

游泳 yóuyǒng • swimming

泳具 yǒngjù • equipment



臂漂
bìpiāo
armband



游泳镜 yóuyǒngjìng | goggles

鼻夹
bíjiá
nose clip



浮板 fúbǎn | float



泳衣 yǒngyī | swimsuit

泳道
yǒngdào
lane

池水
chíshuǐ
water

出发台
chūfātai
starting block



游泳池 yóuyǒngchí | swimming pool

泳帽
yǒngmào
cap

泳裤
yǒngkù
trunks



游泳选手 yóuyǒng xuǎnshǒu | swimmer

跳板
tiàobǎn
springboard

跳水选手
tiàoshuǐ xuǎnshǒu
diver



跳水 tiàoshuǐ | dive (v)



游泳 yóuyǒng | swim (v)



转身 zhuǎnshēn | turn

泳姿 yǒngzī • styles



自由泳 zìyóuyǒng | front crawl



蛙泳 wāyǒng | breaststroke



仰泳 yǎngyǒng | backstroke

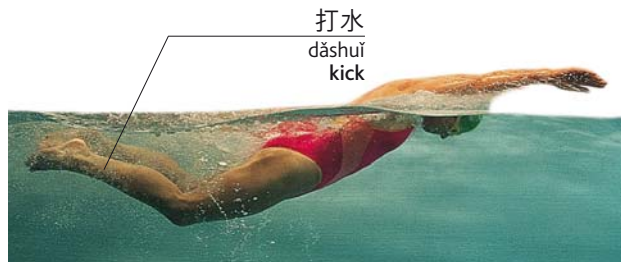

蝶泳 diéyǒng | butterfly

水肺潜水 shuǐfèi qiǎnshuǐ • scuba diving

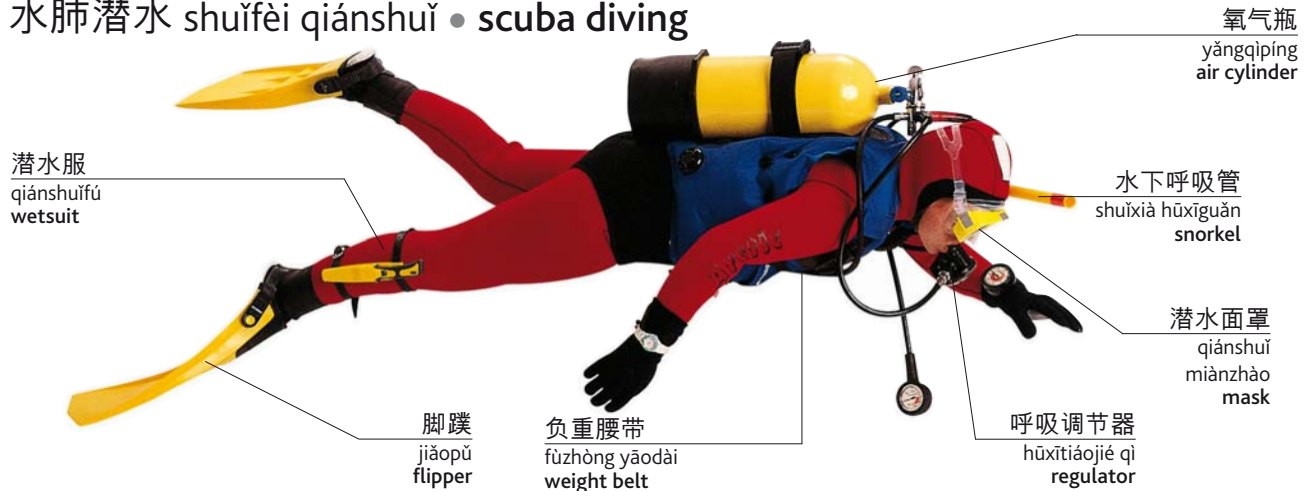

词汇 cíhuì • vocabulary

跳水 tiào shuǐ
dive

踩水 cǎi shuǐ
tread water (v)

锁柜 suǒ guì
lockers

水球 shuǐ qiú
water polo

浅水区 qiǎn shuǐ qū
shallow end

抽筋 chōu jīn
cramp

高台跳水 gāo tái tiào shuǐ
high dive

出发跳水 chū fā tiào shuǐ
racing dive

救生员 jiù shēng yuán
lifeguard

深水区 shēn shuǐ qū
deep end

花样游泳 huā yàng yóu yǒng
synchronized swimming

溺水 nì shuǐ
drown (v)

帆船运动 fānchuán yùndòng • sailing



指南针
zhǐnánzhēn
compass



锚
máo
anchor

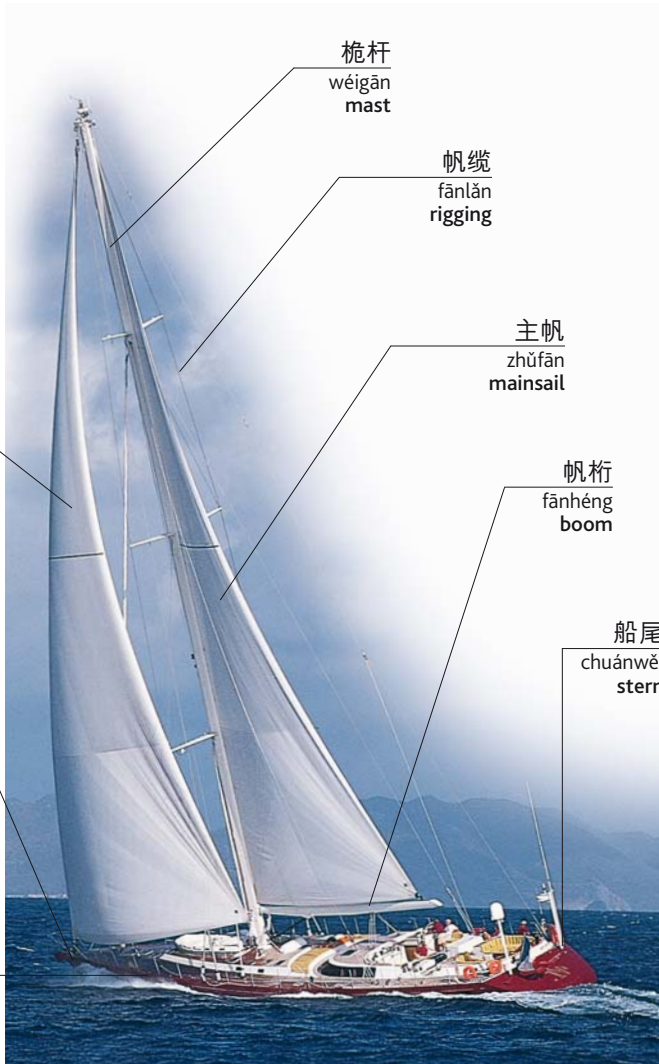

桅杆
wéigān
mast

帆缆
fānlǎn
rigging

主帆
zhǔfān
mainsail

帆桁
fānhéng
boom

船尾
chuánwěi
stern

艏三角帆
shǒusān jiǎofān
headsail

侧舷
cèxián
side deck

船头
chuántóu
bow

舵柄
duòbǐng
tiller

船体
chuántǐ
hull

系索耳
xìsuǒ'ěr
cleat

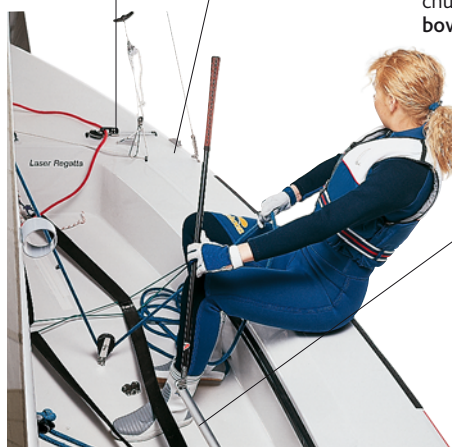

航行 hángxíng | navigate (v)

帆船 fānchuán | yacht

救生器具 jiùshēngqìjù • safety



照明弹
zhàomíngdàn
flare



救生圈
jiùshēngquān
lifebuoy



救生衣
jiùshēngyī
life jacket



救生筏
jiùshēngfá
life raft

水上运动 shuǐshàng yùndòng • watersports



桨手
jiǎngshǒu
rower

桨
jiǎng
oar

划船 huáchuán | row (v)



皮筏
pífá
kayak

双叶桨
shuāngyèjiǎng
paddle

独木舟
dúmùzhōu
canoeing



帆
fān
sail

帆板运动员
fānbǎn
yùndòngyuán
windsurfer

帆板
fānbǎn
board

帆板运动 fānbǎn yùndòng | windsurfing

冲浪板
chōnglàngbǎn
surfboard



冲浪
chōnglàng
surfing

滑水橇
huáshuǐqiāo
ski



滑水
huáshuǐ
waterskiing



快艇
kuàitǐng
speed boating

套脚带
tàojiǎodài
footstrap



皮划艇
píhuá艇
rafting



水上摩托
shuǐshàng mótuō
jet skiing

词汇 cíhuì • vocabulary

滑水者
huáshuǐzhě
waterskier

艇员
tǐngyuán
crew

风
fēng
wind

浪花
lànghuā
surf

帆脚索
fānjiǎosuǒ
sheet

稳向板
wǎnxiàngbǎn
centreboard

冲浪运动员
chōnglàng yùndòngyuán
surfer

抢风航行
qiǎngfēng hángxíng
tack (v)

波浪
bōlàng
wave

激流
jīliú
rapids

舵
duò
rudder

(船)倾覆
(chuán) qīngfù
capsize (v)

马上运动 mǎshàng yùndòng • horse riding



赛事 sàishì • events

赛马
sàimǎ
racehorse



赛马(比赛)
sàimǎ (bǐsài)
horse race

障碍
zhàng'ài
fence



障碍赛
zhàng'aisài
steeplechase



轻驾车赛
qīngjiǎchēsài
harness race



牛仔竞技表演
niúzǎijìngjì biǎoyǎn
rodeo



越障碍赛
yuèzhàng'aisài
showjumping



双套马车赛
shuāngtào mǎchēsài
carriage race



长途旅行 chángtú lǚxíng | trekking



花式骑术 huāshìqíshù | dressage



马球 mǎqiú | polo

词汇 cíhuì • vocabulary

慢步
mànbù
walk

慢跑
mànpǎo
canter

跳跃
tiàoyuè
jump

笼头
lóngtóu
halter

围场
wéichǎng
paddock

无障碍赛马
wúzhàng'aisàimǎ
flat race

小跑
xiǎopǎo
trot

疾驰
jíchí
gallop

马夫
mǎfū
groom

马厩
mǎjiù
stable

竞技场
jìngjìchǎng
arena

赛马场
sàimǎchǎng
racecourse

钓鱼 diàoyú • fishing



铅坠 qiānzhuì | weight

倒钩
dǎogōu
barb



钩眼
gōuyǎn
eye



饵 ěr | bait



浮标
fúbiāo
float

渔钩
yúgōu
fishhook



钓具箱
diào jù xiāng
tackle box



人造饵
rénzào ěr
lure



假蝇
jiǎyíng
fly



抄网
chāowǎng
landing net



活鱼笼
huóyú lóng
keep net

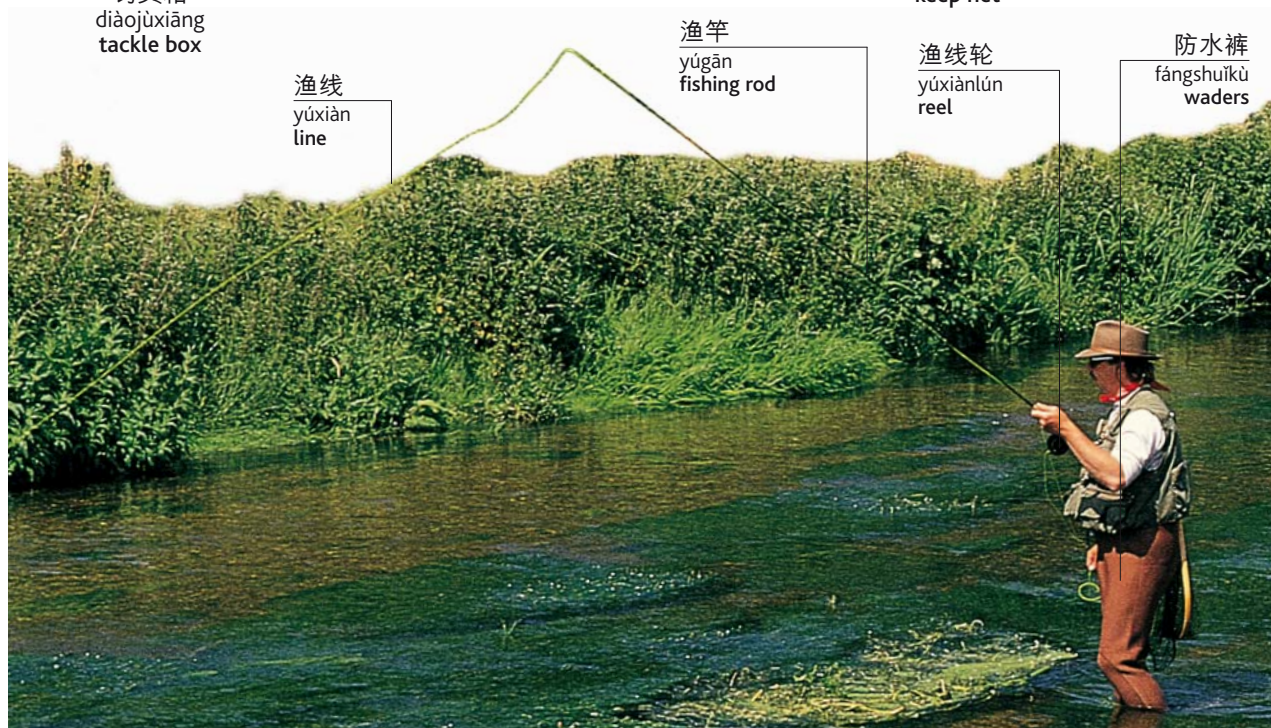

渔线
yúxiàn
line

渔竿
yúgān
fishing rod

渔线轮
yúxiànlún
reel

防水裤
fángshuǐkù
waders

钓鱼者 diàoyúzhě | angler

垂钓种类 chuídiào zhǒnglèi • types of fishing



淡水垂钓
dànshuǐ chuídiào
freshwater fishing



假蝇垂钓
jiǎyīng chuídiào
fly fishing



激浪投钓
jīlàng tóudiào
surfcasting



休闲垂钓
xiūxián chuídiào
sport fishing



深海垂钓
shēnhǎi chuídiào
deep sea fishing

活动 huódòng • activities



撒网
sāwǎng
cast (v)



捕捉
bǔzhuō
catch (v)



收线
shōuxiàn
reel in (v)



网捕
wǎngbǔ
net (v)



放生
fàngshēng
release (v)

词汇 cíhuì • vocabulary

装饵
zhuāng'ěr
bait (v)

钓具
diàojù
tackle

雨衣
yǔyī
waterproofs

钓鱼许可证
diàoyú xǔkězhèng
fishing permit

渔篓
yúlǒu
creel

咬钩
yǎogōu
bite (v)

线轴
xiànzhóu
spool

杆
gān
pole

海洋捕捞
hǎiyáng bǔlāo
marine fishing

渔叉捕鱼
yúchābǔyú
spearfishing

滑雪 huáxuě • skiing

滑雪坡道
huáxuě pōdào
ski slope

缆车吊椅
lǎnchē diàoqǐ
chairlift

缆车
lǎnchē
cable car

滑雪服
huáxuěfú
ski suit

滑雪杖
huáxuězhàng
ski pole

手套
shǒutào
glove

雪道
xuědào
ski run

滑雪靴
huáxuěxié
ski boot

安全护栏
ānquánhùlán
safety barrier

滑雪板
huáxuěbǎn
ski

板边
bǎnbiān
edge

滑雪者
huáxuězhě
skier

板尖
bǎnjiān
tip



项目 xiàngmù • events



高山速降
gāoshān sùjiàng
downhill skiing



旗门杆
qíméngān
gate

小回转
xiǎohuízhuǎn
slalom



跳台滑雪
tiàotái huáxuě
ski jump



越野滑雪
yuèyě huáxuě
cross-country skiing

冬季运动 dōngjì yùndòng • winter sports



攀冰
pānbīng
ice climbing



溜冰
liūbīng
ice-skating



花样滑冰
huāyàng huábing
figure skating

滑雪镜
huáxuějìng
goggles



单板滑雪
dānbǎn huáxuě
snowboarding

冰鞋
bīngxié
skate



长橇滑雪
chángqiāo huáxuě
bobsleigh



小型橇
xiǎoxíngqiāo
luge



机动雪橇
jīdòng xuěqiāo
snowmobile



乘橇滑行
chéngqiāo huáxíng
sledding

词汇 cíhuì • vocabulary

高山滑雪
gāoshān huáxuě
alpine skiing

大回转
dàhuízhuǎn
giant slalom

雪道外
xuědàowài
off-piste

冰上溜石
bīngshàng liúshí
curling

狗拉雪橇
gǒulā xuěqiāo
dog sledding

速滑
sùhuá
speed skating

冬季两项
dōngjì liǎngxiàng
biathlon

雪崩
xuěbēng
avalanche

其他运动 qítāyùndòng • other sports

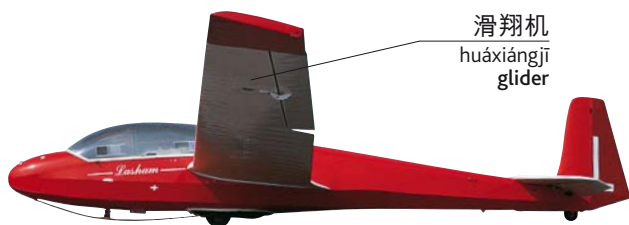

滑翔机
huáxiángjī
glider

悬挂式滑翔机
xuánguàshì
huáxiángjī
hang-glider



悬挂滑翔
xuánguà huáxiáng
hang-glider

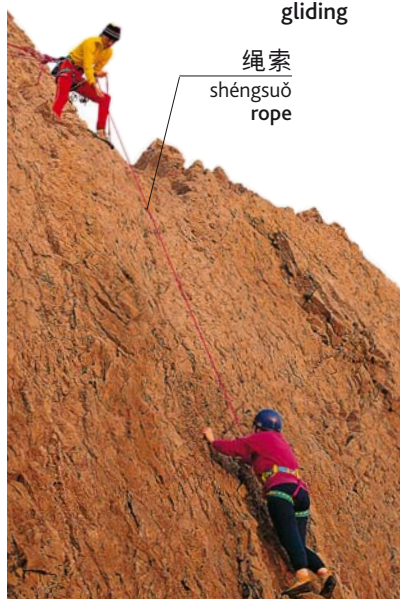

滑翔
huáxiáng
gliding

绳索
shéngsuǒ
rope

攀岩
pānyán
rock climbing



降落伞
jiàngluòsǎn
parachute

跳伞
tiàosǎn
parachuting



滑翔伞
huáxiángsǎn
paragliding



特技跳伞
tèjìtiàosǎn
skydiving



悬绳下降
xuánshéng xiàjiàng
abseiling



蹦极
bèngjí
bungee jumping



汽车拉力赛
qìchē lālìsài
rally driving



赛车手
sàichēshǒu
racing driver

赛车
sàichē
motor racing



摩托车越野赛
mótóuōchē yuèyěsài
motorcross



摩托车赛
mótóuōchēsài
motorbike racing



滑板
huábǎn
skateboard

滑板运动
huábǎn yùndòng
skateboarding

轮滑鞋
lúnhuáxié
rollerskate



滑旱冰
huáhànbing
roller skating

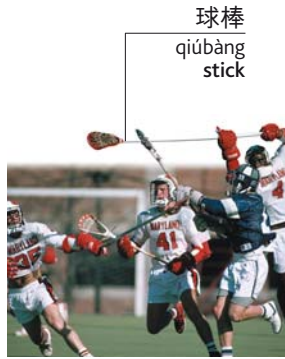

球棒
qiúbàng
stick

长曲棍球
cháng qūgùnqiú
lacrosse



面具
miànjù
mask

花剑
huājiàn
foil

击剑
jījiàn
fencing



保龄球瓶
bǎolíngqiú píng
pin

箭
jiàn
arrow

箭袋
jiàndài
quiver



弓
gōng
bow

射箭
shèjiàn
archery



靶
bǎ
target

射击
shèjī
target shooting

保龄球运动
bǎolíngqiú yùndòng
bowling

保龄球
bǎolíngqiú
bowling ball



美式台球
měishítáiqiú
pool



台球
táiqiú
snooker

健身 jiànshēn • fitness

健身车
jiànshēnchē
exercise bike

力量训练器
lìliàng xùnliàncì
free weights

横杠
hénggàng
bar

健身器械
jiànshēn qìxiè
gym machine

长椅
chángyǐ
bench



划船机
huáchuánjī
rowing machine

健身房
jiànshēnfáng
gym



跑步机
pǎobùjī
treadmill



交叉训练器
jiāochā xùnliàncì
cross trainer



私人教练
sīrén jiàoliàn
personal trainer



踏步机
tàbùjī
step machine

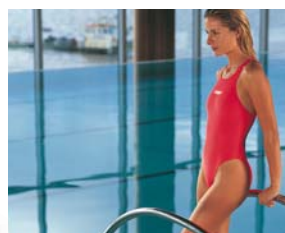

游泳池
yóuyǒngchí
swimming pool



桑拿浴
sāngnáyù
sauna

锻炼 duànliàn • exercises



伸展腿
shēnzhǎntuǐ
stretch



弓箭步压腿
gōngjiǎnbù yātuǐ
lunge

紧身衣
jǐnshēnyī
tights



俯卧撑
fǔwòchēng
press-up



蹲起
dūnqǐ
squat



仰卧起坐
yǎngwòqǐzuò
sit-up



二头肌训练
èrtóujī xùnliàn
bicep curl

哑铃
yǎlíng
dumb bell



蹬腿
dēngtuǐ
leg press



扩胸
kuòxiōng
chest press



运动鞋
yùndòngxié
trainers

杠铃横杆
gānglíng hénghān
weight bar

重量训练
zhòngliàng xùnliàn
weight training



慢跑
mànpǎo
jogging

背心
bèixīn
vest

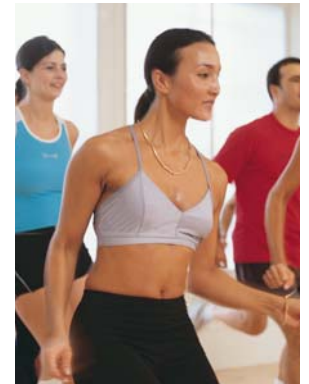

有氧运动
yǒuyǎng yùndòng
aerobics

词汇 cíhuì • vocabulary

训练
xùnliàn
train (v)

原地跑
yuándìpǎo
jog on the spot (v)

伸展
shēnzhǎn
extend (v)

普拉提
pǔlātī
Pilates

循环训练法
xúnhuán xùnliàn fǎ
circuit training

热身
rèshēn
warm up (v)

弯曲(四肢)
wānqū (sìzhī)
flex (v)

引体向上
yǐntǐ xiàngshàng
pull up (v)

搏击操
bójīcāo
boxercise

跳绳
tiàoshéng
skipping



休闲 xiūxián
leisure

剧院 jùyuàn • theatre



幕
mù
curtain

舞台侧翼
wú tái cè yì
wings

布景
bù jǐng
set

观众
guānzhòng
audience

乐队
yuèduì
orchestra

舞台 wǔtái | stage

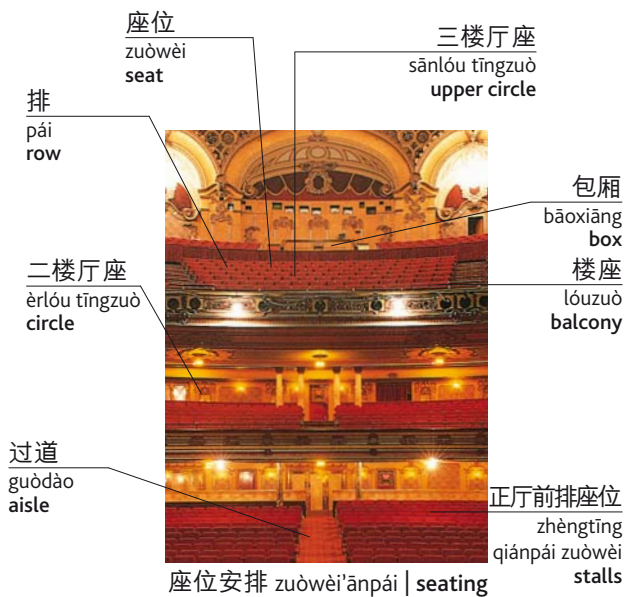

座位
zuòwèi
seat

三楼厅座
sānlóu tīngzuò
upper circle

排
pái
row

包厢
bāoxiāng
box

二楼厅座
èrlóu tīngzuò
circle

楼座
lóuzuò
balcony

过道
guòdào
aisle

正厅前排座位
zhèngtīng
qiánpái zuòwèi
stalls

座位安排 zuòwèi'ānpái | seating

词汇 cíhuì • vocabulary

角色分配
juésè fēnpèi
cast

剧本
jùběn
script

首演
shǒuyǎn
first night

男演员
nányǎnyuán
actor

背景幕布
bèijǐngmùbù
backdrop

幕间休息
mùjiānxiūxi
interval

女演员
nǚyǎnyuán
actress

导演
dǎoyǎn
director

节目
jiémù
programme

戏剧
xìjù
play

制片人
zhìpiānrén
producer

乐池
yuèchí
orchestra pit



音乐会 yīnyuèhuì | concert



音乐剧 yīnyuèjù | musical



戏装
xìzhuāng
costume

芭蕾舞 bālěiwǔ | ballet



歌剧 gējù | opera

词汇 cíhuì • vocabulary

引座员
yǐnzuo yuán
usher

古典音乐
gǔdiǎn yīnyuè
classical music

乐谱
yuèpǔ
musical score

声带
shēngdài
soundtrack

鼓掌喝彩
gǔzhǎng hècǎi
applaud (v)

再来一次
zàilái yí cì
encore

演出什么时候开始？
yǎnchū shénme shíhòu kāishǐ?
What time does it start?

我想要两张今晚演出的票。
wǒ xiǎng yào liǎngzhāng jīnwǎn
yǎnchūde piào.
I'd like two tickets for tonight's
performance.

电影院 diànyǐngyuàn • cinema

爆米花
bào mǐ huā
popcorn



大厅
dà tīng
lobby

售票处
shòu piào chù
box office



海报
hǎi bào
poster



电影放映厅
diànyǐng fàngyǐng tīng
cinema hall



银幕
yín mù
screen

词汇 cíhuì • vocabulary

喜剧片
xǐjù piān
comedy

惊险片
jīngxiǎn piān
thriller

恐怖片
kǒngbù piān
horror film

西部片
xībù piān
western

爱情片
àiqíng piān
romance

科幻片
kēhuàn piān
science fiction film

冒险片
mào xiǎn piān
adventure

动画片
dòng huà piān
animated film

乐队 yuèduì • orchestra

弦乐器 xiányuèqì • strings



钢琴 gāngqín | piano

乐谱 yuèpǔ
score

低音谱号 dīyīn pǔhào
bass clef

高音谱号 gāoyīn pǔhào
treble clef

音符 yīnfú
note

五线谱 wǔxiànpǔ
staff



记谱法 jìpǔfǎ | notation

词汇 cíhuì • vocabulary

序曲 xùqǔ
overture

奏鸣曲 zòumíngqǔ
sonata

休止符 xiūzhǐfú
rest

升号 shēnghào
sharp

本位号 běnwèihào
natural

音阶 yīnjiē
scale

交响乐 jiāoxiǎngyuè
symphony

乐器 yuèqì
instruments

音高 yīngāo
pitch

降号 jiàngào
flat

小节线 xiǎojiéxiàn
bar

指挥棒 zhǐhuībàng
baton

木管乐器 mùguǎnyuèqì • woodwind



短笛
duǎndí
piccolo



长笛
chángdí
flute



双簧管
shuānghuánguǎn
oboe



英国管
yīngguóguǎn
cor anglais



萨克斯管
sàkèsīguǎn
saxophone



单簧管
dānhuánguǎn
clarinet



低音单簧管
dīyīn dānhuánguǎn
bass clarinet



巴松管
bāsōngguǎn
bassoon



倍低音管
bèidīyīnguǎn
double bassoon

打击乐器 dǎjīyuèqì • percussion



定音鼓
dìngyīngǔ
kettledrum



锣
luó
gong



邦戈鼓
bānggēgǔ
bongos



小军鼓
xiǎojūngǔ
snare drum



钹
bó
cymbals



铃鼓
língǔ
tambourine



颤音琴
chànyīnqín
vibraphone



三角铁
sānjiǎotiě
triangle



沙锤
shāchuí
maracas

铜管乐器 tóngguǎn yuèqì • brass



小号
xiǎohào
trumpet



长号
cháng hào
trombone



圆号
yuánhào
French horn



大号
dàhào
tuba

音乐会 yīnyuèhuì • concert



麦克风
màikēfēng
microphone

主唱
zhǔchàng
lead singer

鼓手
gǔshǒu
drummer

吉他手
jítāshǒu
guitarist

歌迷
gēmí
fans

低音吉他手
dīyīn jítāshǒu
bass guitarist

扩音器
kuòyīnqì
speaker

摇滚音乐会 yáogǔn yīnyuèhuì | rock concert

乐器 yuèqì • instruments

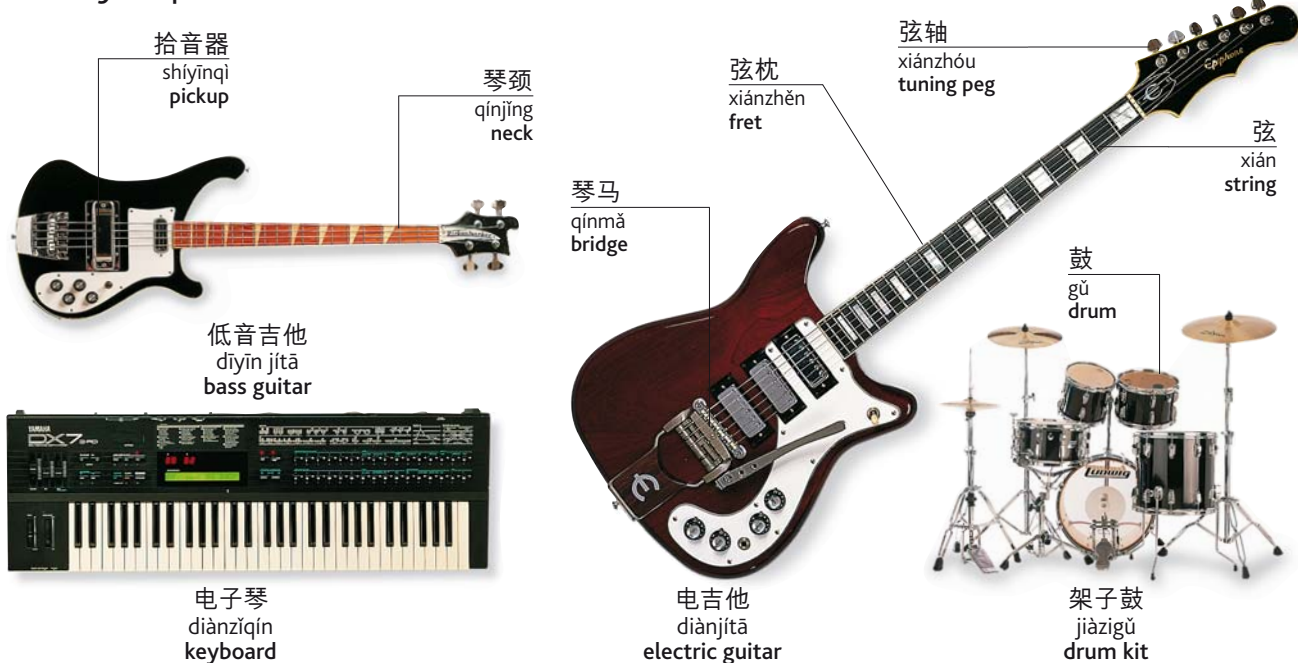

拾音器
shíyīnqì
pickup

琴颈
qínjǐng
neck

弦枕
xiánzhěn
fret

弦轴
xiánzhóu
tuning peg

弦
xián
string

琴马
qínmǎ
bridge

低音吉他
dīyīn jítā
bass guitar

鼓
gǔ
drum

电子琴
diànzǐqín
keyboard

电吉他
diànjítā
electric guitar

架子鼓
jiàzǐgǔ
drum kit

音乐风格 yīnyuè fēnggé • musical styles



爵士乐 juéshìyuè | jazz



蓝调音乐 lándiào yīnyuè | blues



朋克音乐 péngkè yīnyuè | punk



民间音乐 mínjiān yīnyuè | folk music



流行音乐 liúxíng yīnyuè | pop



舞曲 wǔqǔ | dance



说唱音乐 shuōchàng yīnyuè | rap



重金属摇滚 zhòngjīnshǔyáoqǔn
heavy metal



古典音乐 gǔdiǎn yīnyuè
classical music

词汇 cíhuì • vocabulary

歌曲
gēqǔ
song

歌词
gēcí
lyrics

旋律
xuánlǜ
melody

节拍
jiépāi
beat

雷盖音乐
léigài yīnyuè
reggae

乡村音乐
xiāngcūn yīnyuè
country

聚光灯
jùguāngdēng
spotlight

观光 guānguāng • sightseeing

游客
yóukè
tourist



游览胜地 yóulǎn shèngdì | tourist attraction

旅行路线
lǚxíng lùxiàn
itinerary

敞篷
chǎngpéng
open-top



观光巴士 guānguāngbāshi | tour bus

导游
dǎoyóu
tour guide



团体旅游
tuántǐlǚyóu
guided tour

小雕像
xiǎodiāoxiàng
statuette



纪念品
jìniànpǐn
souvenirs

词汇 cíhuì • vocabulary

开门
kāimén
open

旅行指南
lǚxíngzhǐnán
guide book

便携式摄像机
biànxìeshì shèxiàngjī
camcorder

左
zuǒ
left

...在哪里?
...zàinǎlǐ?
Where is...?

关门
guānmén
closed

胶片
jiāopiàn
film

照相机
zhàoxiàngjī
camera

右
yòu
right

我迷路了。
wǒ mílùle.
I'm lost.

入场费
rùchǎngfèi
entrance fee

电池
diànchí
batteries

(行路的)指引
(xínglùde) zhǐyīn
directions

直行
zhíháng
straight on

你能告诉我到...的路吗?
nǐ néng gào sù wǒ dào...delù ma?
Can you tell me the way to...?

名胜 míngshèng • attractions

绘画
huìhuà
painting



艺术馆
yìshùguǎn
art gallery

展品
zhǎnpǐn
exhibit

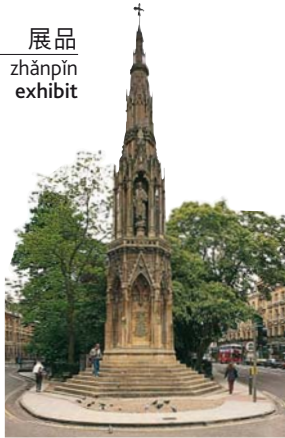

纪念碑
jìniànbēi
monument

展览
zhǎnlǎn
exhibition



博物馆
bówùguǎn
museum

古迹
gǔjī
famous ruin



历史建筑
lìshǐ jiànzhù
historic building



赌场
dǔchǎng
casino



庭园
tíngyuán
gardens



国家公园
guójiā gōngyuán
national park

游览信息 yóulǎnxìnxī • information

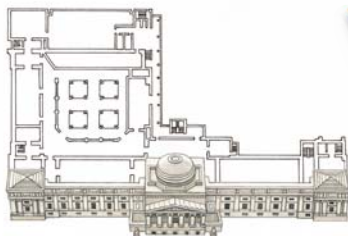

平面图
píngmiàntú
floor plan



地图
dìtú
map

日程
rìchéng
times



时刻表
shíkèbiǎo
timetable



旅游问询处
lǚyóu wènxúnchù
tourist information

户外活动 hùwài huódòng • outdoor activities

小道
xiǎodào
footpath

日晷
rìguǐ
sundial

咖啡馆
kāfēiguǎn
café

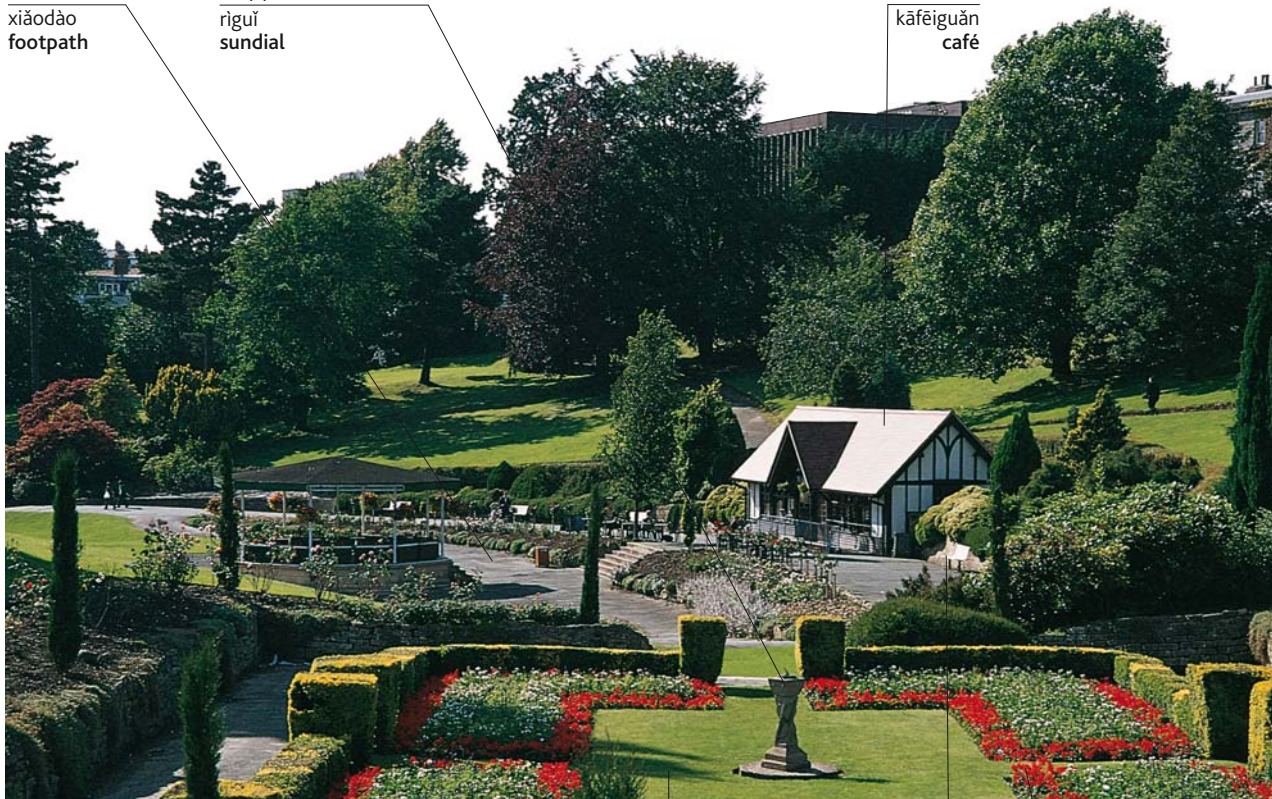

公园 gōngyuán | park

草坪
cǎopíng
grass

长椅
chángyǐ
bench

法式花园
fǎshì huāyuán
formal gardens

过山车
guòshānchē
roller coaster



游乐园
yóulèyuán
fairground



主题公园
zhǔtí gōngyuán
theme park



野生动物园
yěshēng dòngwùyuán
safari park



动物园
dòngwùyuán
zoo

活动 huódòng • activities



骑自行车
qízìxíngchē
cycling



慢跑
mànpǎo
jogging



滑板
huábǎn
skateboarding



滚轴溜冰
gǔnzhóu liūbīng
rollerblading

骑马专用道
qímǎ zhuānyòngdào
bridle path



观鸟
guānniǎo
bird watching



骑马
qímǎ
horse riding



远足
yuǎnzú
hiking

食物篮
shíwùlán
hamper



野餐
yěcān
picnic

游乐场 yóulèchǎng • playground



沙箱
shāxiāng
sandpit



儿童戏水池
értóng xishuǐchí
paddling pool



秋千
qiūqiān
swings



攀登架 pāndēngjià | climbing frame



跷跷板 qiāoqiāobǎn | seesaw



滑梯 huátī | slide

海滩 hǎitān • beach

旅馆
lǚguǎn
hotel

遮阳伞
zhēyángsǎn
beach umbrella

海滩小屋
hǎitān xiǎowū
beach hut

沙
shā
sand

海浪
hǎilàng
wave

海
hǎi
sea



海滨游泳袋
hǎibīn yóuyǒngdài
beach bag

比基尼泳装
bǐjīnīyǒngzhuāng
bikini

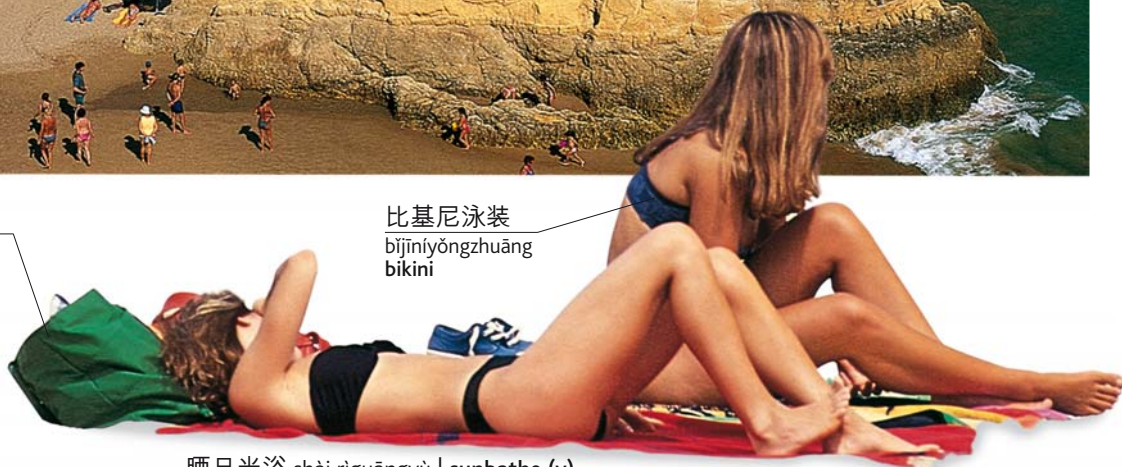

晒日光浴 shài rìguāngyù | sunbathe (v)



救生员
jiùshēngyuán
lifeguard

救生瞭望塔
jiùshēng liáowàngtǎ
lifeguard tower

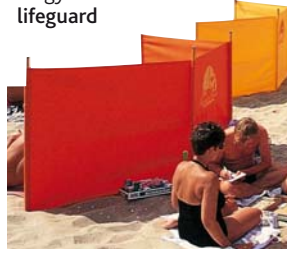

防风屏
fángfēngpíng
windbreak



海滨步道
hǎibīn bùdào
promenade



轻便折叠躺椅
qīngbiàn zhédiétǎngyǐ
deck chair



太阳镜
tàiyángjìng
sunglasses



遮阳帽
zhēyángmào
sunhat



防晒油
fángshàiyou
suntan lotion



防晒液
fángshàiè
sunblock



浮水气球
fúshuǐqìqiú
beach ball



游泳圈
yóuyǒngquān
rubber ring

游泳衣
yóuyǒngyī
swimsuit

铲子
chǎnzi
spade

桶
tǒng
bucket



沙堡
shābǎo
sandcastle

贝壳
bèiké
shell



海滩浴巾
hǎitān yùjīn
beach towel

露营 lùyíng • camping



卫生间
wèishēngjiān
toilets

垃圾箱
lājīxiāng
waste disposal

浴室
yùshì
shower block

接电装置
jiēdiàn zhuāngzhì
electric hook-up

防雨罩
fángyǔzhào
flysheet

地钉
dìdīng
tent peg

防风绳
fángfēng shéng
guy rope

旅行拖车
lǚxíng tuōchē
caravan

露营地 lùyíngdì | campsite

词汇 cíhuì • vocabulary

露营
lùyíng
camp (v)

宿营地
sùyíngdì
pitch

野餐长椅
yěcān chángyǐ
picnic bench

木炭
mùtàn
charcoal

营地管理处
yíngdì guǎnlǐchù
site manager's office

支帐篷
zhīzhàngpéng
pitch a tent (v)

吊床
diàochuáng
hammock

引火物
yǐnhuǒwù
firelighter

自由宿营地
zìyóu sùyíngdì
pitches available

帐篷杆
zhàngpénggān
tent pole

野营车
yěyíngchē
camper van

点火
diǎnhuǒ
light a fire (v)

满
mǎn
full

行军床
xíngjūn chuáng
camp bed

拖车
tuōchē
trailer

营火
yínghuǒ
campfire



支架
zhījià
frame

铺地防潮布
pūdi fāngcháo bù
ground sheet

背包
bèibāo
backpack

保温瓶
bǎowēnpíng
vacuum flask

水瓶
shuǐpíng
water bottle

帐篷
zhāngpéng
tent



驱虫剂
qūchóngjì
insect repellent



营地灯
yíngdìdēng
torch

蚊帐
wénzhàng
mosquito net

保暖内衣
bǎowǎn nèiyī
thermals



徒步靴
túbùxuē
walking boots



雨衣
yǔyī
waterproofs



睡袋
shuìdài
sleeping bag



野营炉
yěyínglú
camping stove



烧烤架
shāokǎojià
barbecue

睡垫
shuìdiàn
sleeping mat



充气床垫 chōngqì chuángdiàn | air mattress

家庭娱乐 jiā tíng yú lè • home entertainment



便携式CD播放机
biànxíeshì CD bōfàngjī
personal CD player



MD录放机
MD lùfàngjī
mini disk recorder



MP3播放机
MP3 bōfàngjī
MP3 player

DVD光盘
DVD guāngpán
DVD disk



DVD播放机
DVD bōfàngjī
DVD player

电唱机
diànchàngjī
record player

CD播放机
CD bōfàngjī
CD player

收音机
shōuyīnjī
radio

功率放大器
gōnglǜ fàngdàqì
amplifier

耳机
ěrjī
headphones

搁架
gējià
stand

音箱
yīnxiāng
(loud) speaker

音箱架
yīnxiāngjià
speaker stand

高保真音响系统 gāobǎozhēn yīnxiǎng
xìtǒng | hi-fi system



录像带
lùxiàngdài
video tape

录像机
lùxiàngjī
video recorder



显示屏
xiǎnshìpíng
screen

便携式摄像机
biànxíeshì shèxiàngjī
camcorder



接目杯
jiēmùbēi
eyecup

卫星电视天线
wèixīng diànshì tiānxiàn
satellite dish

宽屏电视
kuānpíng diànshì
widescreen television



操纵手柄
cāozòng shǒubǐng
controller

视频游戏 shìpín yóuxì | video game

控制台
kòngzhìtái
console



快进
kuàijìn
fast forward

暂停
zàntíng
pause

录制
lùzhì
record

音量
yīnliàng
volume

倒带
dǎodài
rewind

播放
bōfàng
play

停止
tíngzhǐ
stop



遥控器 yáokòngqì | remote control

词汇 cíhuì • vocabulary

激光唱盘
jīguāng chàngpán
compact disc

故事片
gùshìpiàn
feature film

节目
jiémù
programme

收费频道
shōufèi píndào
pay per view channel

看电视
kàndiànshì
watch television (v)

盒式录音带
héshì lùyīndài
cassette tape

广告
guǎnggào
advertisement

立体声
lìtǐshēng
stereo

换频道
huàn píndào
change channel (v)

关电视
guāndiànshì
turn the television off (v)

盒式磁带录音机
héshì cídài lùyīnjī
cassette player

数字式
shùzìshì
digital

有线电视
yǒuxiàn diànshì
cable television

开电视
kāidiànshì
turn the television
on (v)

调收音机
diàoshōuyīnjī
tune the radio (v)

摄影 shèyǐng • photography

曝光记数器
bàoguāngjì shùqì
frame counter

闪光灯
shǎnguāngdēng
flash

光圈调节环
guāngquān tiáojiéhuán
aperture dial

快门键
kuàimén jiàn
shutter release



滤镜
lǜjìng
filter



镜头盖
jìngtóugài
lens caps

快门速度调节钮
kuàimén sùdù tiáojiéniǔ
shutter-speed dial

镜头
jìngtóu
lens

单镜头反光照相机 dānjìngtóu fǎnguāngzhàoxiàngjī | SLR camera



三脚架
sānjiǎojià
tripod



闪光灯
shǎnguāngdēng
flash gun



曝光表
bàoguāngbiǎo
lightmeter



变焦镜头
biànjiāo jìngtóu
zoom lens

相机种类 xiàngjī zhǒnglèi • types of camera



数码相机
shùmǎ xiàngjī
digital camera



一次成像全自动相机
yīcìchéngxiàng quánzìdòng
xiàngjī
APS camera



立拍立现相机
lìpāi lìxiàn xiàngjī
instant camera



一次性相机
yīcìxìng xiàngjī
disposable camera

照相 zhàoxiàng • photograph (v)



胶卷
jiāojiǎn
film spool

胶片
jiāopiàn
film



调焦
tiáojiāo
focus (v)



冲洗
chōngxǐ
develop (v)



底片
dǐpiān
negative

全景照
quánjǐngzhào
landscape

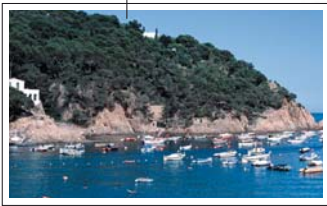

相片 xiàngpiān | photograph

人像照
rénxiàngzhào
portrait

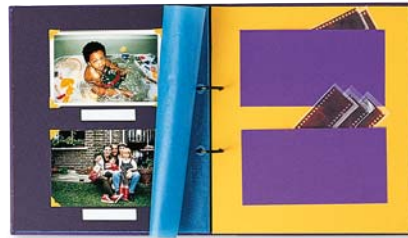

相册
xiàngcè
photo album



相框
xiāngkuàng
photo frame

问题 wèntí • problems



曝光不足
pùguāng bùzú
underexposed



曝光过度
pùguāng guòdù
overexposed



调焦不准
tiáojiāo bùzhǔn
out of focus



红眼
hóngyǎn
red eye

词汇 cíhuì • vocabulary

取景器
qǔjǐngqì
viewfinder

相机盒
xiàngjīhé
camera case

曝光
pùguāng
exposure

暗室
ànshì
darkroom

样片
yàngpiàn
print

无光泽
wúguāngzé
mat

有光泽
yǒuguāngzé
gloss

放大
fàngdà
enlargement

请冲洗这个胶卷。
qǐng chōngxǐ zhège jiāojiǎn.
I'd like this film processed

游戏 yóuxì • games

棋盘
qípán
chessboard

黑格
hēigé
black

白格
báigé
white

后
hòu
queen

王
wáng
king

兵
bīng
pawn

马
mǎ
knight

象
xiàng
bishop

车
chē
rook

方格
fānggé
square

国际象棋
guójìxiàngqí
chess

字牌
zìpái
tile

棋子
qízǐ
piece

拼字游戏 pīnzì yóuxì | scrabble

国际跳棋
guójìtiàiqí
draughts

骰子
tóuzǐ
dice

筹码
chóumǎ
counter

强手棋
qiángshǒuqí
monopoly

西洋双陆棋 xīyáng shuānglùqí | backgammon

棋盘游戏 qípán yóuxì | board games



集邮 jíyóu | stamp collecting



拼图 pīntú | jigsaw puzzle



多米诺骨牌 duōmīnuò de gǔpái dominoes

靶盘 bǎpán dartboard

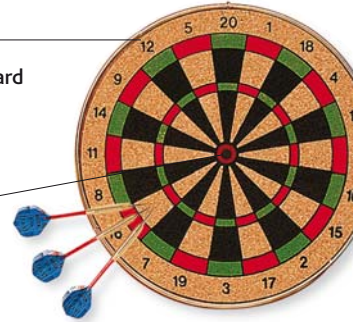

靶心 bǎxīn bullseye

飞镖 fēibiāo | darts

王牌 wángpái joker

J zhei jack

Q kiu queen

K kei king

A ei ace

纸牌 zhǐpái | cards



方块 fāngkuài diamond

黑桃 hēitáo spade

红心 hóngxīn heart

梅花 méihuā club



洗牌 xǐpái | shuffle (v)



发牌 fāpái | deal (v)

词汇 cíhuì • vocabulary

走棋 zǒuqí move

赢 yíng win (v)

输家 shūjiā loser

点 diǎn point

桥牌 qiáopái bridge

掷骰子 zhītóuzi. Roll the dice.

玩 wán play (v)

赢家 yíngjiā winner

游戏 yóuxì game

得分 défēn score

一副牌 yīfùpái pack of cards

该谁了? gāishuile? Whose turn is it?

玩家 wánjiā player

输 shū lose (v)

赌注 dǔzhù bet

扑克牌 pūkèpái poker

同花 tonghuā suit

该你了。gāinǐle. It's your move.

工艺美术 1 gōngyīměishù yī • arts and crafts 1



(用颜料等)绘画 (yòng yánliào děng) huìhuà | painting

颜料 yánliào • paints



油画颜料 yóuhuà yánliào
oil paints



水彩画颜料 shuǐcǎi huàyánliào
watercolour paint



彩色蜡笔 cǎisèlàbǐ
pastels



丙烯颜料 bǐngxī yánliào
acrylic paint



广告颜料 guǎnggào yánliào | poster paint

颜色 yánsè • colours



红色 hóngsè | red



蓝色 lánsè | blue



黄色 huángsè
yellow



绿色 lǜsè | green



橘色 júse | orange



紫色 zǐsè | purple



白色 báisè | white



黑色 hēisè | black



灰色 huīsè | grey



粉红色 fēnhóngsè
pink



褐色 hèsè | brown



靛青色 diànqīngsè
indigo

其他工艺 qítā gōngyì • other crafts

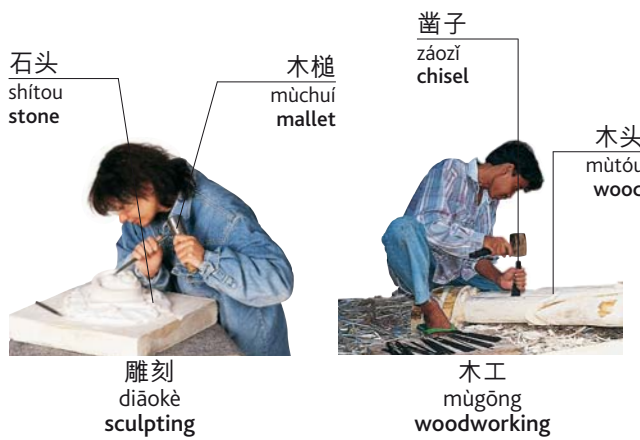
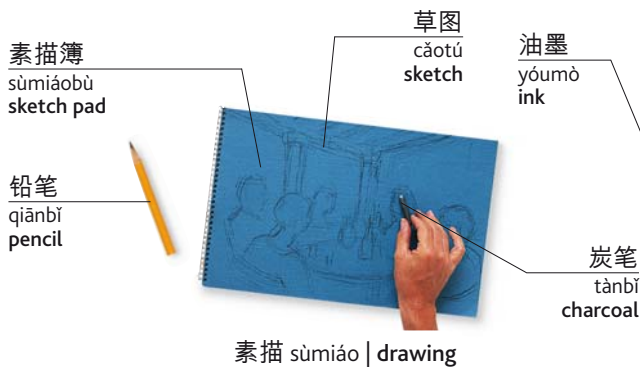

工艺美术 2 gōngyīměishùèr • arts and crafts 2



缝纫机 féngrènjī | sewing machine



剪刀 jiǎndāo scissors



纸样 zhǐyàng pattern



针线筐 zhēnxiānkuāng | sewing basket



卷尺 juǎnchǐ tape measure



布料 bùliào material

针垫 zhēndiàn pincushion

大头针 dàtóuzhēn pin



线轴 xiànzhóu bobbin



线 xiàn thread



领钩 lǐnggōu hook

领钩环 lǐnggōuhuán eye



顶针 dǐngzhēn thimble



划粉 huáfěn tailor's chalk



人体模型 réntǐ móxíng tailor's dummy

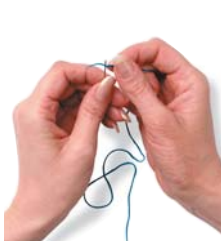

穿针
chuānzhēn
thread (v)



缝
féng
sew (v)

针脚
zhēnjiǎo
stitch



织补
zhībǔ
darn (v)



粗缝
cūféng
tack (v)



剪裁
jiǎncái
cut (v)



绒绣
róngxiù
needlepoint



刺绣
cìxiù
embroidery

钩针
gōuzhēn
crochet hook



钩织
gōuzhī
crochet



流苏花边
liúsū huābiān
macramé



拼缝
pīnféng
patchwork



绗缝
hángféng
quilting



织边
zhībiān
lace-making

线轴
xiànzhóu
lace bobbin

织布机
zhībùjī
loom



纺织
fǎngzhī
weaving

词汇 cíhuì • vocabulary

拆开
chāikāi
unpick (v)

尼龙
nílóng
nylon

布匹
bùpǐ
fabric

丝绸
sīchóu
silk

棉布
miánbù
cotton

设计师
shèjìshī
designer

亚麻布
yàmábù
linen

时尚
shíshàng
fashion

聚酯
jùzhǐ
polyester

拉链
lāliàn
zip



编织针
biānzhīzhēn
knitting needle

编织 biānzhī | knitting



毛线
máoxiàn
wool

线束 xiànshù | skein





环境 huánjìng
environment

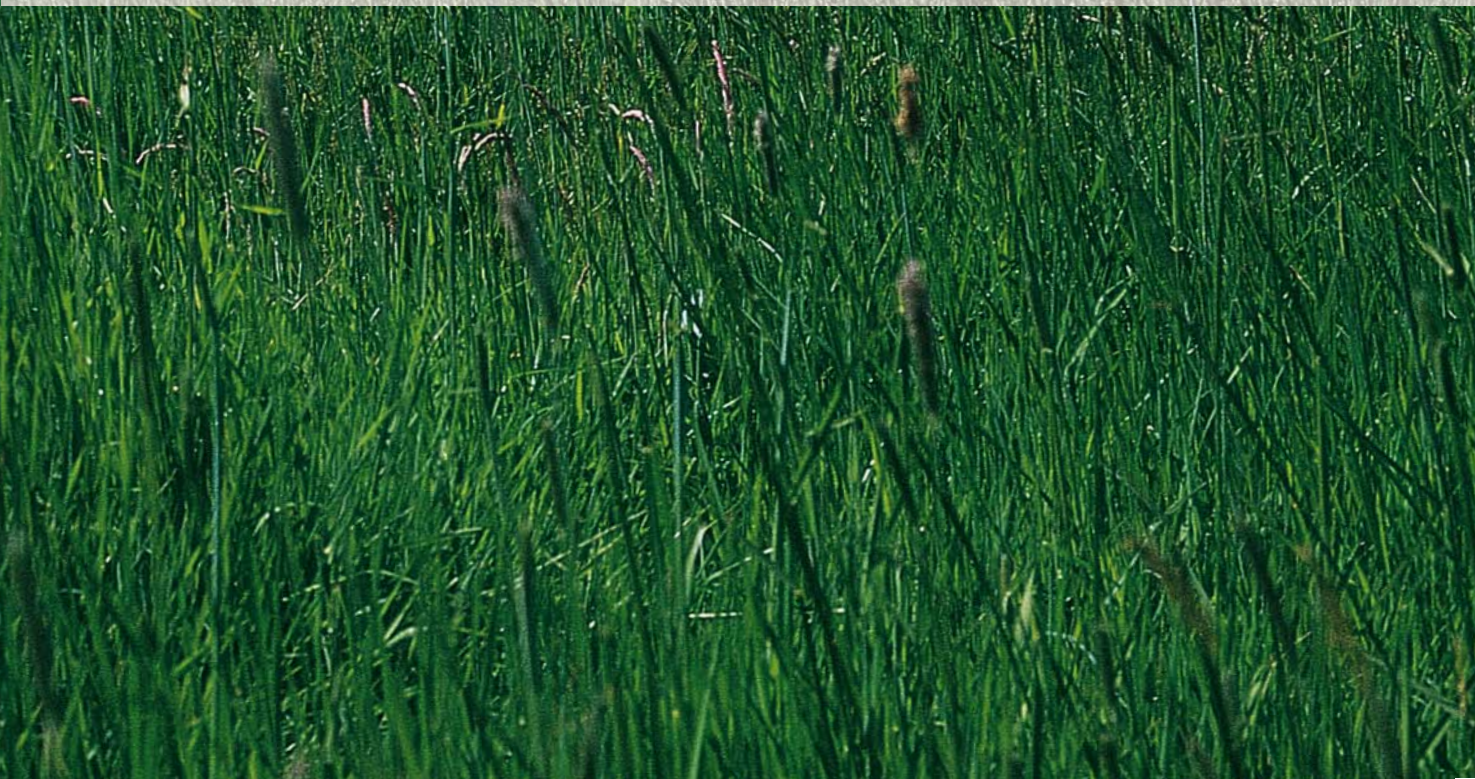

宇宙空间 yǔzhòukōngjiān • space

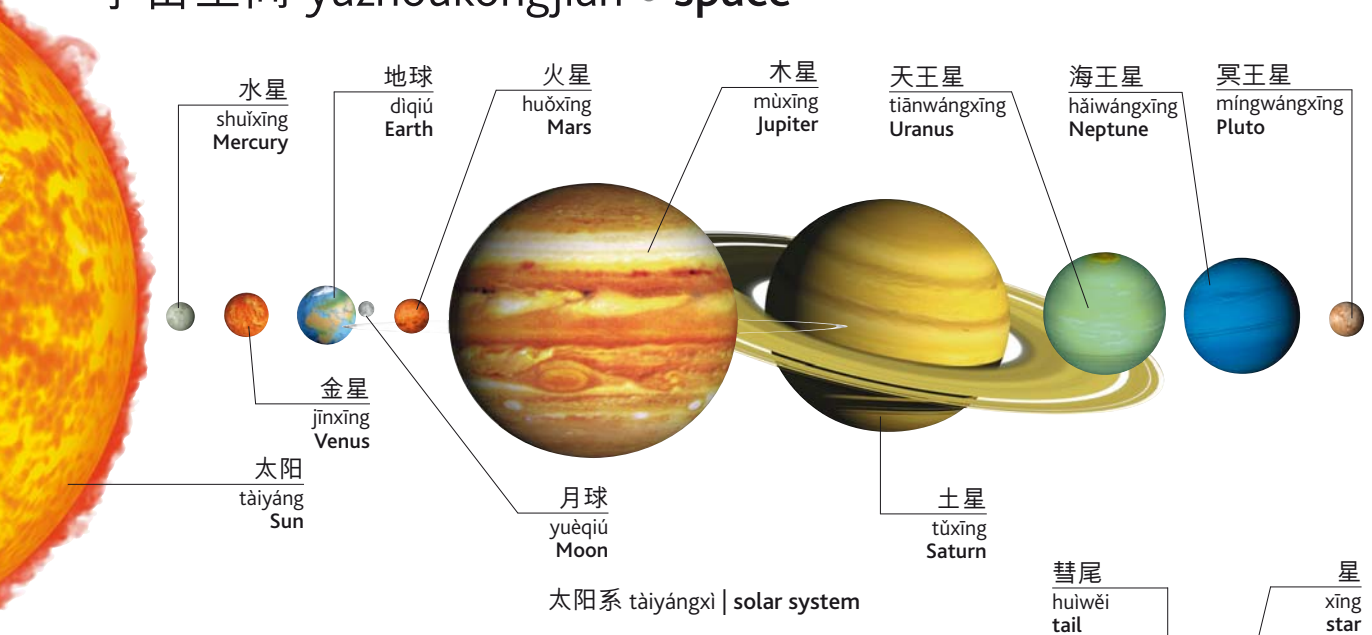

星系 xīngxì galaxy



星云 xīngyún nebula



小行星 xiǎoxīngxīng asteroid



彗星 huìxīng comet

词汇 cíhuì • vocabulary

宇宙 yǔzhòu universe	黑洞 hēidòng black hole	满月 mǎnyuè full moon
轨道 guǐdào orbit	行星 xíngxīng planet	新月 xīnyuè new moon
重力 zhònglì gravity	流星 liúxīng meteor	弦月 xiányuè crescent moon

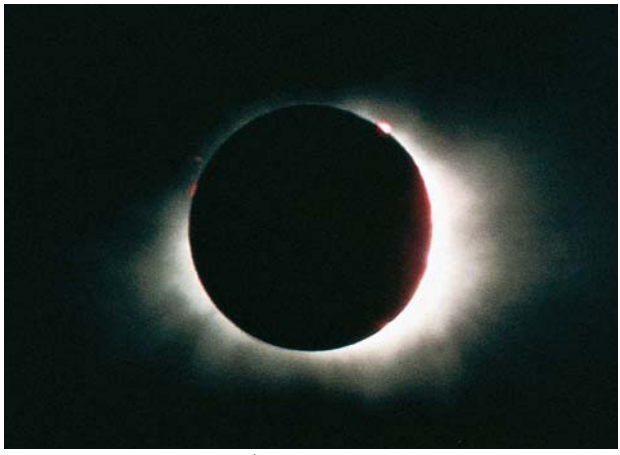

(日、月)食 (rì, yuè) shí | eclipse

太空探索 tàikōngfú • space exploration



航天飞机
hángtiān fēijī
space shuttle

推进器
tuījìnqì
booster

太空服
tàikōngfú
space suit



宇航员 yǔhángyuán
astronaut

发射架
fāshèjià
launch pad



人造卫星
rénzàowèixīng
satellite

发射
fāshè
launch

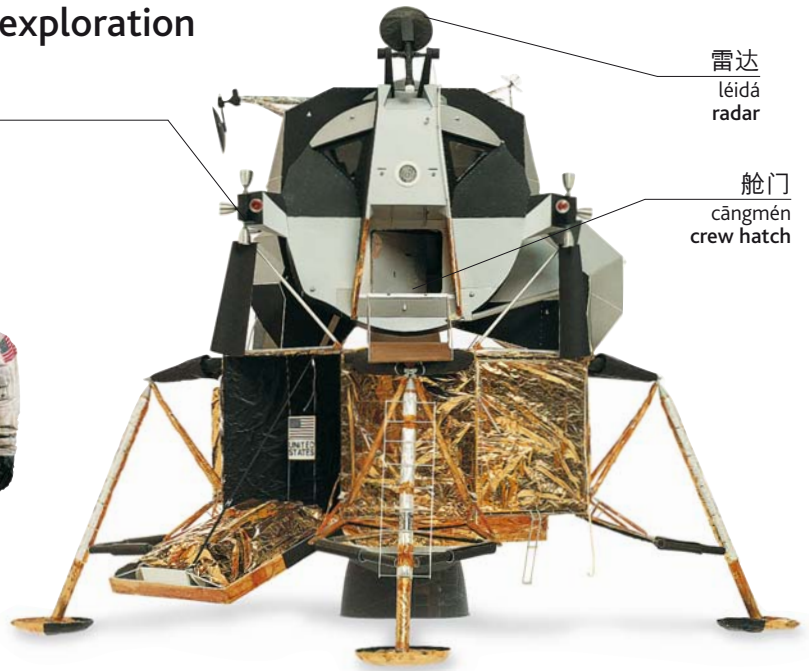

雷达
léidá
radar

舱门
cāngmén
crew hatch

登月舱 dēngyuècāng | lunar module



空间站
kōngjiān zhàn
space station

天文学 tiānwénxué • astronomy



星座
xīngzuò
constellation



双筒望远镜
shuāngtǒng wàngyuǎnjìng
binoculars



天文望远镜
tiānwén
wàngyuǎnjìng
telescope

三脚架
sānjiǎojià
tripod

地球 dìqiú • Earth

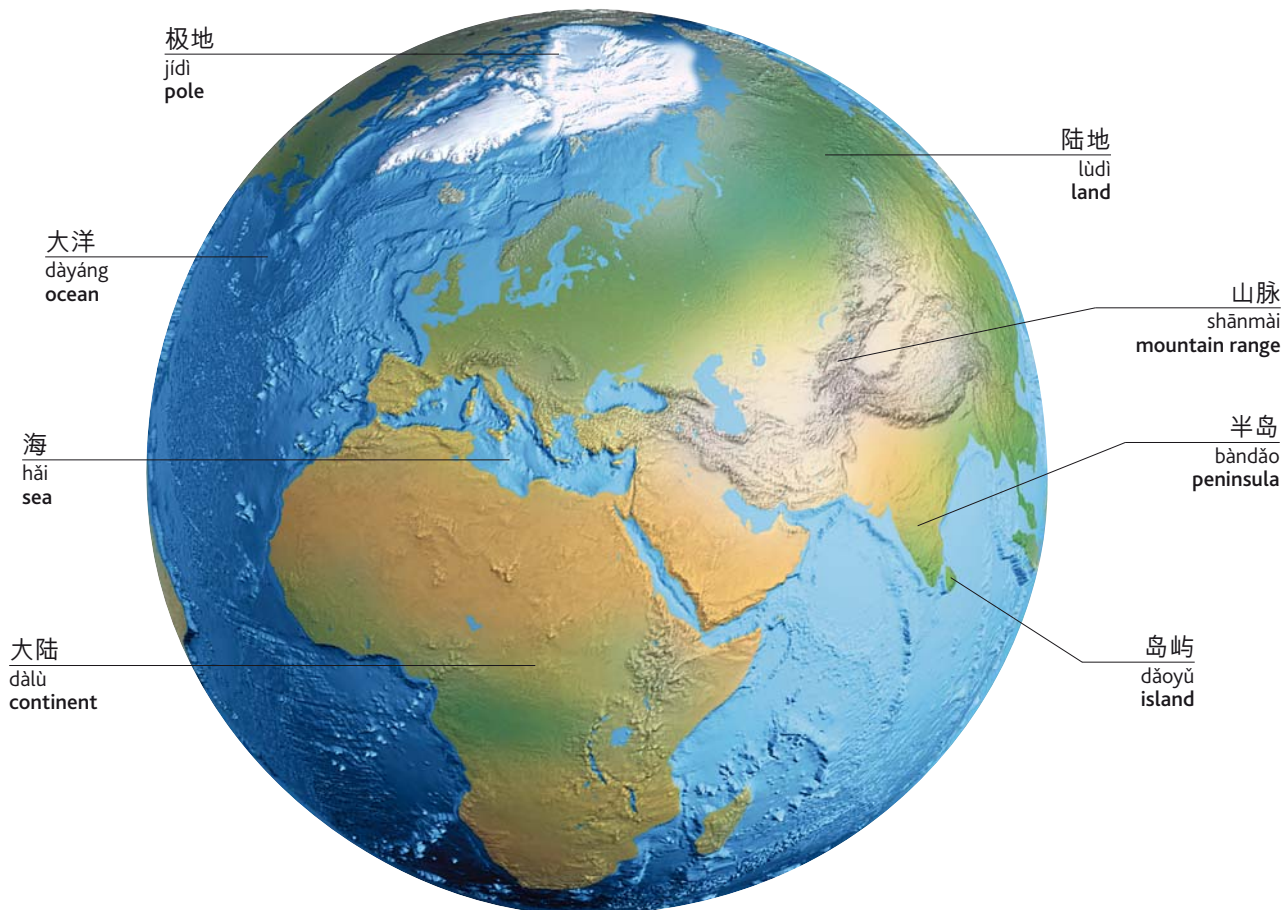

行星 xíngxīng | planet

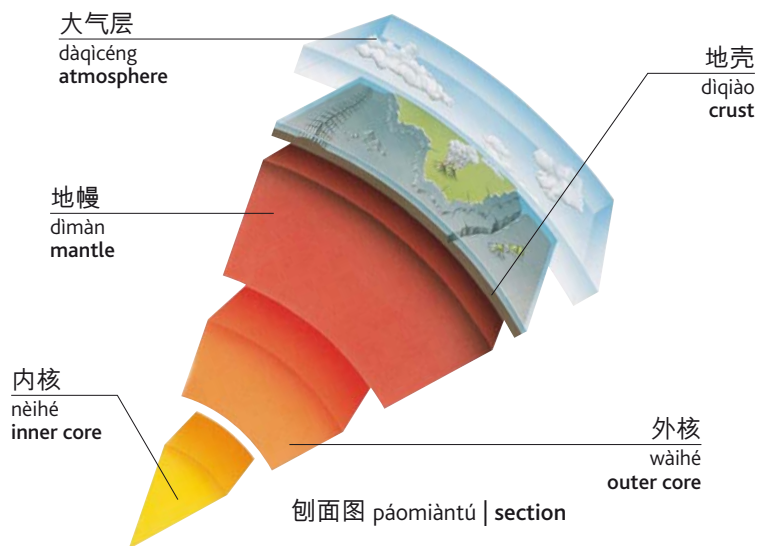

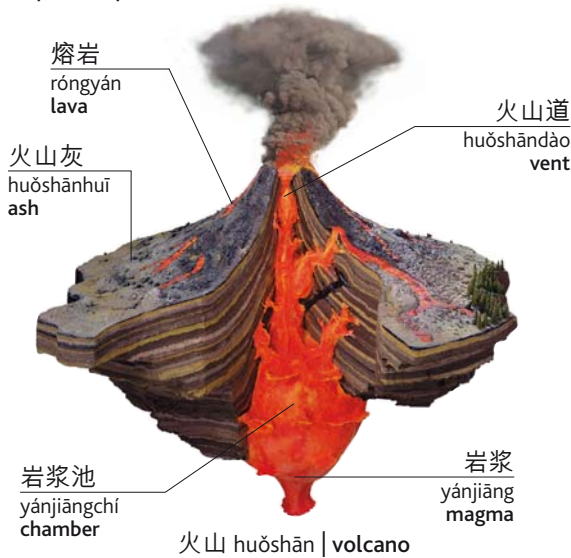
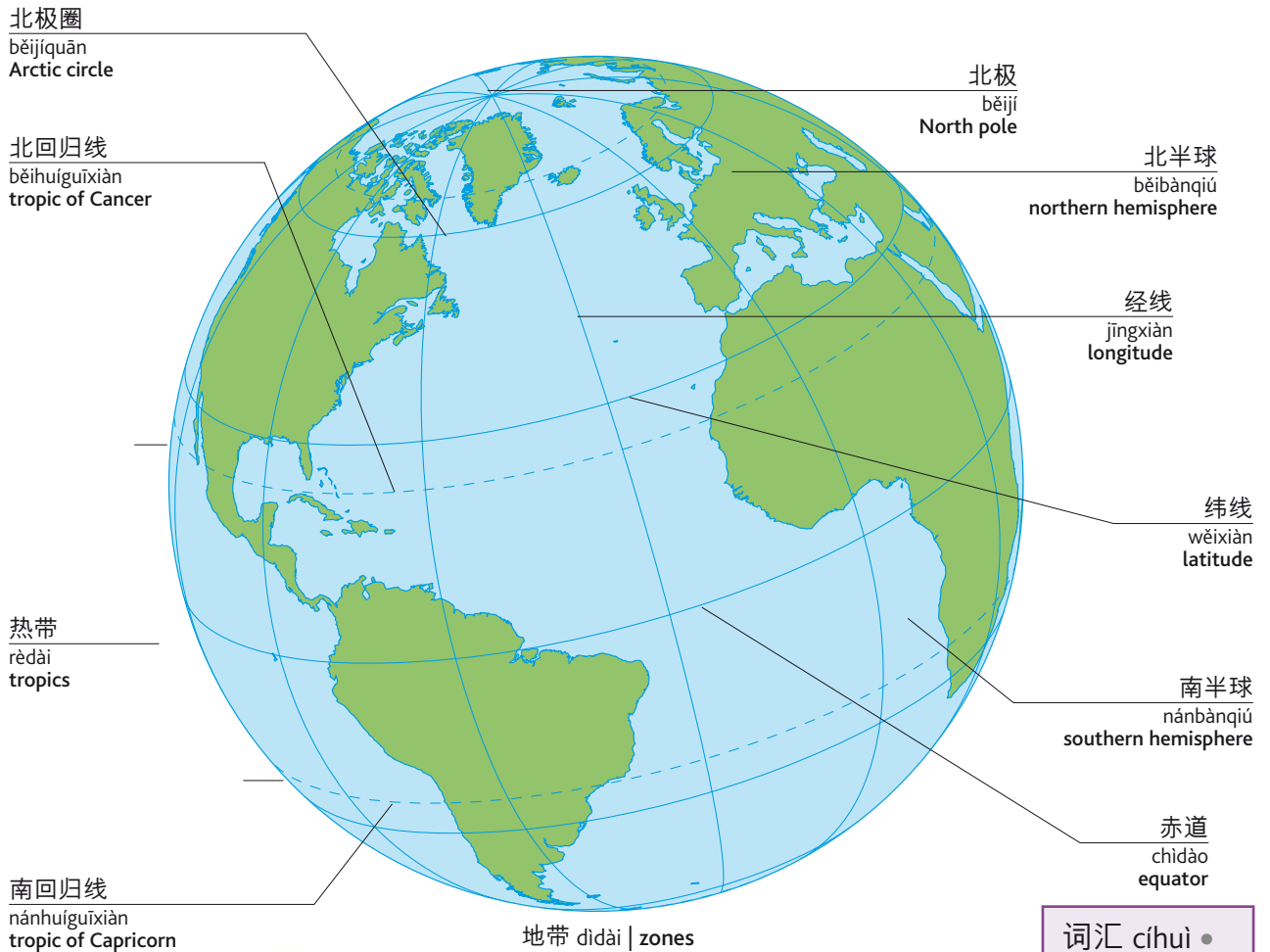

火山口 huǒshānkǒu | crater

词汇 cíhuì •
vocabulary

地震
dìzhèn
earthquake

板块
bǎnkuài
plate

喷发
pēnfā
erupt (v)

震动
zhèndòng
tremor

地貌 dìmào • landscape

山
shān
mountain

山坡
shānpō
slope

河岸
hé'àn
bank

河流
héliú
river

急流
jīliú
rapids

岩石
yánshí
rocks

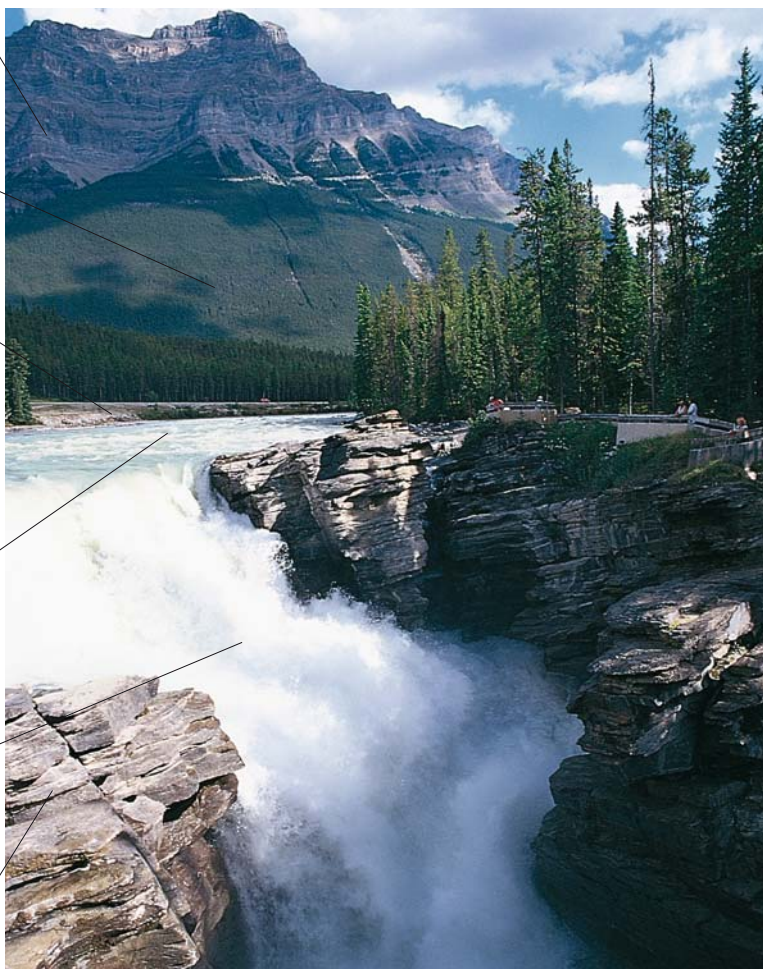

冰河
bīnghé
glacier



山谷 shāngǔ | valley

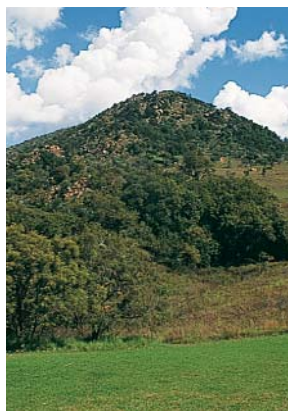

丘陵
qiūlíng
hill



高原
gāoyuán
plateau



峡谷
xiágǔ
gorge

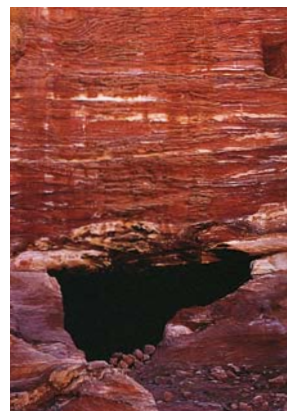

岩洞
yándòng
cave



平原 píngyuán | plain



沙漠 shāmò | desert



森林 sēnlín | forest



树林 shùlín | wood



雨林
yǔlín
rainforest



沼泽
zhāozé
swamp



草场
cǎochǎng
meadow



草原
cǎoyuán
grassland



瀑布
pùbù
waterfall



溪流
xīliú
stream



湖
hú
lake



间歇喷泉
jiànxiē pēnquán
geyser



海岸
hǎi'àn
coast



悬崖
xuányá
cliff



珊瑚礁
shānhújiāo
coral reef



河口
hékǒu
estuary

天气 tiānqì • weather

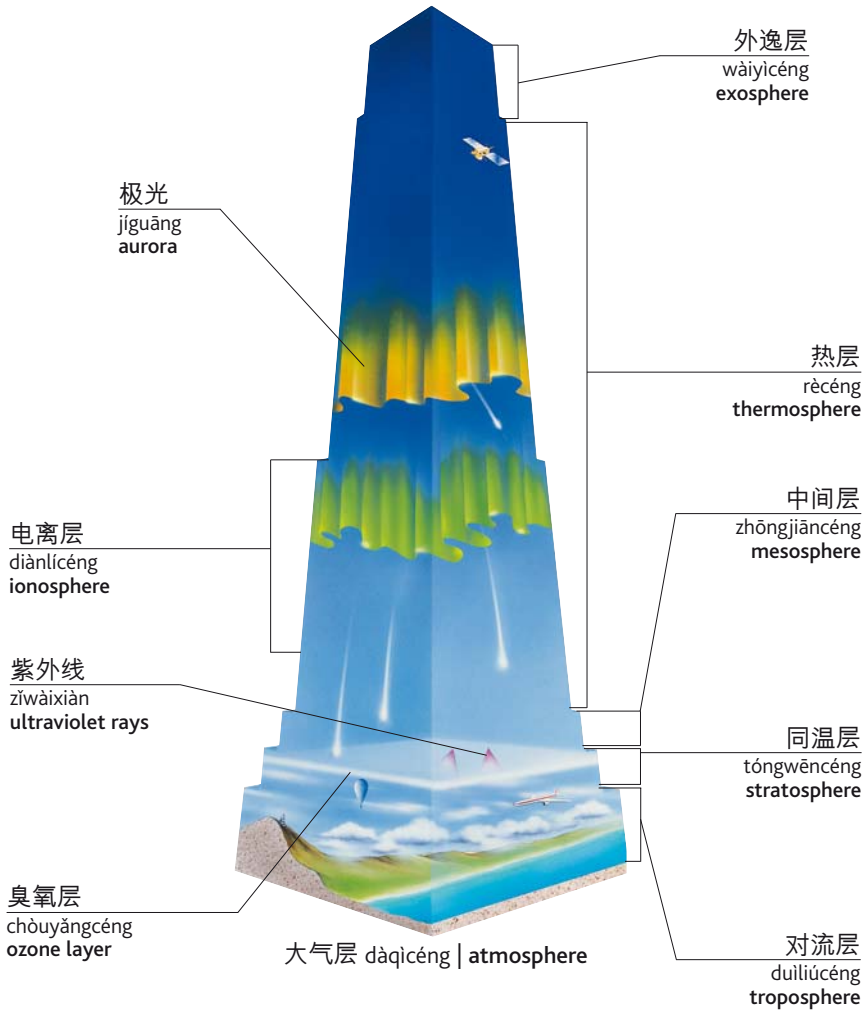

阳光 yángguāng | sunshine



风 fēng | wind

词汇 cíhuì • vocabulary

雨夹雪
yǔjiāxuě
sleet

阵雨
zhènyǔ
shower

热
rè
hot

干燥
gānzào
dry

多风
duōfēng
windy

我热/冷。
wǒ rè/lěng.
I'm hot/cold.

冰雹
bīngbào
hail

阳光明媚
yángguāng míngmèi
sunny

冷
lěng
cold

潮
cháo
wet

狂风
kuángfēng
gale

正在下雨。
zhèngzài xiàyǔ.
It's raining.

雷
léi
thunder

多云
duōyún
cloudy

温暖
wēnuǎn
warm

湿润
shīrùn
humid

温度
wēndù
temperature

度...
dù...
It's ... degrees.



云 yún | cloud



雨 yǔ | rain

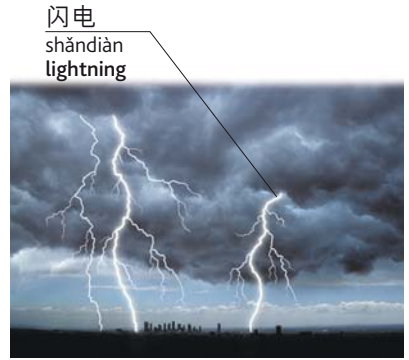

闪电
shǎndiàn
lightning

暴风雨 bàofēngyǔ | storm



雾 wù | mist



雾 wù | fog



彩虹 cǎihóng | rainbow

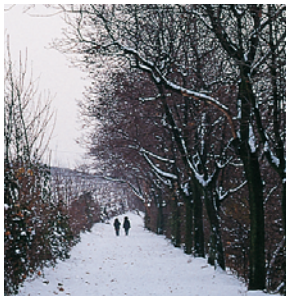

雪 xuě | snow



霜 shuāng | frost



冰 bīng | ice



冰柱
bīngzhù
icicle

结冰 jiébīng | freeze



飓风 jùfēng | hurricane



龙卷风 lóngjuǎnfēng
tornado



季风 jìfēng | monsoon



洪水 hóngshuǐ | flood

岩石 yánshí • rocks

火成岩 huǒchéngyán • igneous



花岗岩
huāgāngyán
granite



黑曜岩
hēiyàoyán
obsidian



玄武岩
xuánwǔyán
basalt



浮石
fúshí
pumice

沉积岩 chénjīyán • sedimentary



砂岩
shāyán
sandstone



石灰岩
shíhuīyán
limestone



白垩
bái'è
chalk



燧石
suǐshí
flint



砾岩
lìyán
conglomerate



煤
méi
coal

变质岩 biànzhìyán • metamorphic



板岩
bǎnyán
slate



页岩
yèyán
schist



片麻岩
piànmáyán
gneiss



大理石
dàlǐshí
marble

宝石 bǎoshí • gems

红宝石
hóngbǎoshí
ruby



海蓝宝石
hǎilánbǎoshí
aquamarine



紫水晶
zǐshuǐjīng
amethyst



钻石
zuànshí
diamond



玉石
yùshí
jade



黑玉
hēiyù
jet



绿宝石
lǜbǎoshí
emerald



蛋白石
dànbáishí
opal



蓝宝石
lánbǎoshí
sapphire



月长石
yuèzhǎngshí
moonstone



石榴石
shíliúshí
garnet



黄玉
huángyù
topaz



电气石
diànqìshí
tourmaline



矿物 kuàngwù • minerals



石英
shíyīng
quartz



云母
yúnmǔ
mica



硫磺
liúhuáng
sulphur



赤铁矿
chìtiěkuàng
hematite



方解石
fāngjiěshí
calcite



孔雀石
kǒngquèshí
malachite



绿松石
lǜsōngshí
turquoise



缟玛瑙
gǎomǎnǎo
onyx

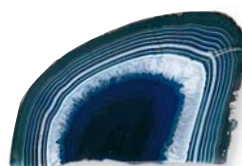

玛瑙
mǎnǎo
agate



石墨
shímò
graphite

金属 jīnshǔ • metals



金属
jīnshǔ
gold



银
yín
silver



铂
bó
platinum



镍
niè
nickel



铁
tiě
iron



铜
tóng
copper



锡
xī
tin



铝
lǚ
aluminium



汞
gǒng
mercury



锌
xīn
zinc

动物 1 dòngwùyī • animals 1

哺乳动物 bǔrǔ dòngwù • mammals



兔子
tùzǐ
rabbit



仓鼠
cāngshǔ
hamster

腮须
sāixū
whiskers



小家鼠
xiǎojiāshǔ
mouse

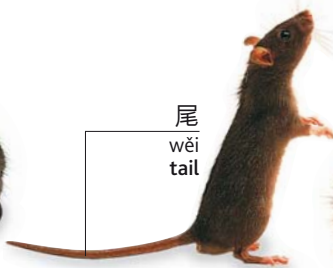

尾
wěi
tail

老鼠
lǎoshǔ
rat



刺猬
cìwēi
hedgehog



松鼠
sōngshǔ
squirrel



蝙蝠
biānfú
bat



浣熊
huànxióng
raccoon



狐狸
húlí
fox



狼
láng
wolf

小狗
xiǎogǒu
puppy



狗
gǒu
dog

小猫
xiǎomāo
kitten



猫
māo
cat

小海豹
xiǎohǎibào
pup



水獭
shuǐtǎ
otter



海豹
hǎibào
seal



海狮
hǎishī
sea lion

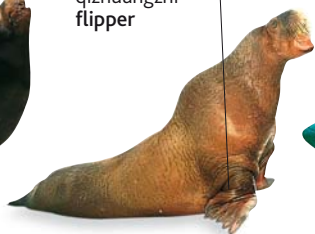

鳍状肢
qízuàngzhī
flipper

海象
hǎixiàng
walrus

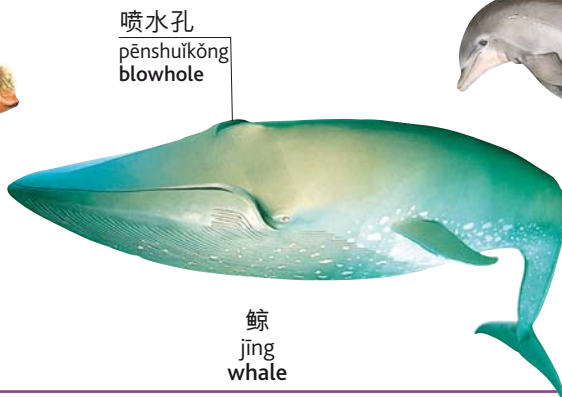

喷水孔
pēnshuǐkǒng
blowhole

鲸
jīng
whale



海豚
hǎitún
dolphin



鹿
lù
deer

鹿角
lùjiǎo
antler

鬃毛
zōngmáo
mane

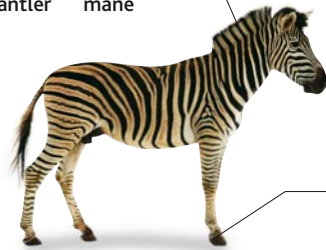

斑马
bānmǎ
zebra

蹄
tí
hoof



长颈鹿
chángjǐnglù
giraffe



驼峰
tuófēng
hump

骆驼
luòtuó
camel



河马
hémǎ
hippopotamus

象鼻
xiàngbí
trunk

长牙
chángyá
tusk

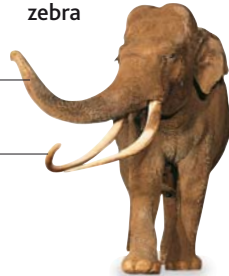

象
xiàng
elephant

角
jiǎo
horn



犀牛
xīniú
rhinoceros



虎
hǔ
tiger



狮子
shīzi
lion

鬃毛
zōngmáo
mane



猴子
hóuzi
monkey



大猩猩
dàxīngxīng
gorilla



树袋熊
shùdài xióng
koala



袋鼠
dàishǔ
kangaroo

育儿袋
yù'ěrdài
pouch



熊
xióng
bear

爪
zhǎo
claw



北极熊
běijí xióng
polar bear

熊猫
xióngmāo
panda



动物 2 dòngwùèr • animals 2

鸟 niǎo • birds



金丝雀
jīnsīquè
canary



麻雀
máquè
sparrow



蜂鸟
fēngniǎo
hummingbird



燕子
yànzi
swallow



乌鸦
wūyā
crow



鸽子
gēzi
pigeon



啄木鸟
zhuómùniǎo
woodpecker



隼
sǔn
falcon



猫头鹰
māotóuyīng
owl



海鸥
hǎi'ōu
gull

鹰
yīng
eagle



鹈鹕
tíhú
pelican



火烈鸟
huǒlièniǎo
flamingo



鹤
guàn
stork



鹤
hè
crane



企鹅
qīe
penguin



鸵鸟
tuóniǎo
ostrich



鹅 é | goose



天鹅 tiān é swan



孔雀 kǒng què peacock



雉 zhì pheasant



火鸡 huǒ jī turkey



美冠鸚鵡 měi guān yīng wǔ cockatoo

喙 huì bill



羽毛 yǔ máo feather

翅膀 chī bǎng wing

爪 zhǎo claw

鸚鵡 yīng wǔ parrot

爬行动物 pá xíng dòng wù • reptiles

鳞 lín scales



短吻鳄 duǎn wěn è alligator



蜥蜴 xī yì lizard

鬣蜥 liè xī iguana

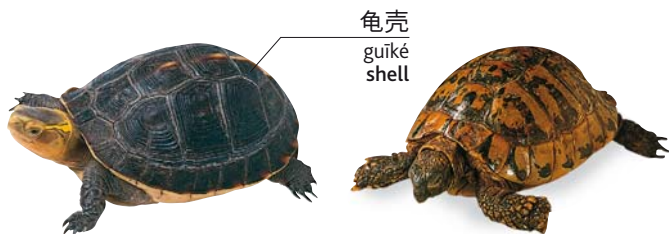

龟壳 guī ké shell

海龟 hǎi guī turtle

龟 guī tortoise

蛇 shé snake



吻 wěn snout



鳄鱼 è yú crocodile

动物 3 dòngwùsān • animals 3

两栖动物 liǎngqī dòngwù • amphibians



蛙
wā
frog



蟾蜍
chánchú
toad



蝌蚪
kēdǒu
tadpole



蝾螈
róngyuán
salamander

鱼类 yúlei • fish



鳗鱼
mányú
eel

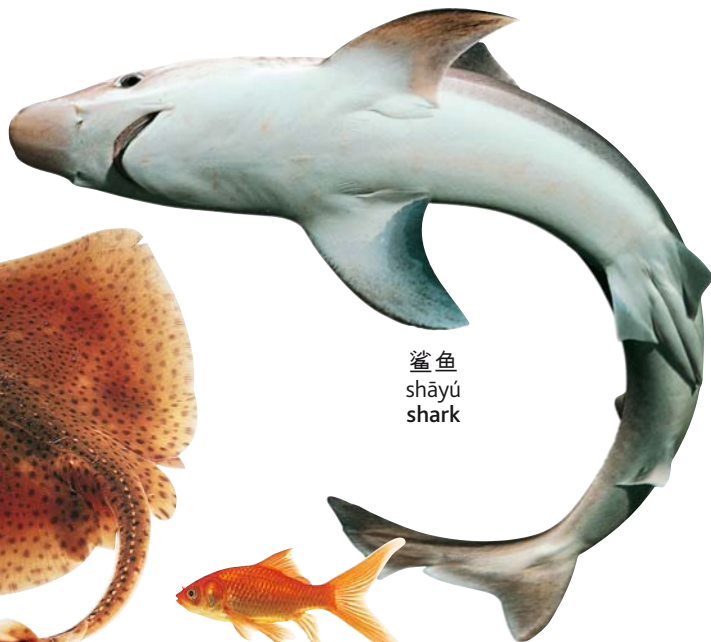

鲨鱼
shāyú
shark



海马
hǎimǎ
sea horse



鳐鱼
yáoyú
skate

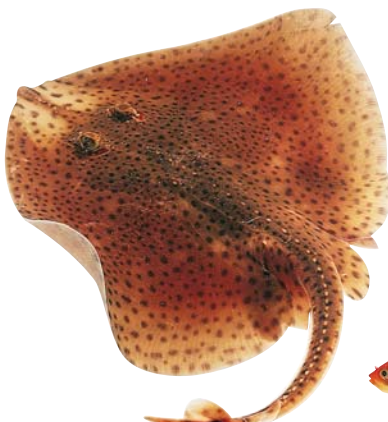

魟鱼
hóngyú
ray



金鱼
jīnyú
goldfish



剑鱼 jiànyú | swordfish

背鳍
bèiqí
dorsal fin

胸鳍
xiōngqí
pectoral fin

尾
wěi
tail

鳃
sāi
gill

鳞
lín
scale

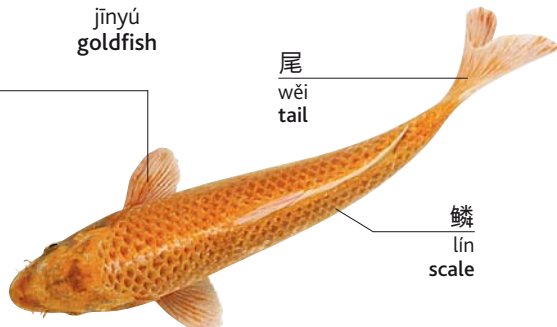

鲤鱼 lǐyú | koi carp

无脊椎动物 wújǐzhūi dòngwù • invertebrates



蚂蚁
mǎyǐ
ant



白蚁
báiyǐ
termite



蜜蜂
mífēng
bee



黄蜂
huángfēng
wasp



甲壳虫
jiǎqiào chóng
beetle



蟑螂
zhāngláng
cockroach



蛾
é
moth



蝴蝶
húdié
butterfly

触角
chùjiǎo
antenna



茧
jiǎn
cocoon



毛虫
máo chóng
caterpillar



蟋蟀 xīshuài | cricket



蚱蜢
zhà mǐng
grasshopper



螳螂
tángláng
praying mantis



蜇针
zhēzhēn
sting

蝎子
xiēzi
scorpion



蜈蚣
wúgōng
centipede



蜻蜓
qīngtīng
dragonfly



蒼蝇
cāngyīng
fly



蚊子
wénzi
mosquito



瓢虫
piāo chóng
ladybird



蜘蛛
zhīzhū
spider



蛞蝓
kuòyú
slug



蜗牛
wōniú
snail



蚯蚓 qiūyǐn | worm



海星
hǎixīng
starfish



贻贝
yíbei
mussel



螃蟹 pángxiè | crab



龙虾 lóngxiā | lobster



章鱼 zhāngyú | octopus



鱿鱼 yóuyú | squid



水母 shuǐmǔ | jellyfish

植物 zhíwù • plants

树 shù • tree

树枝
shùzhī
branch

根
gēn
root

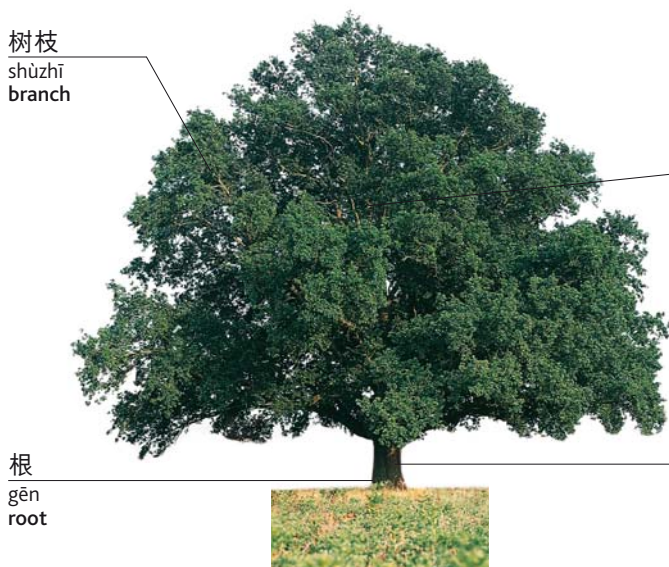

橡树 xiàngshù | oak



落叶松
luòyèsōng
larch



山毛榉
shānmáojǔ
beech



桦树
huàshù
birch



松树
sōngshù
pine



雪松
xuěsōng
cedar



枫树
fēngshù
maple



榆树
yúshù
elm



椴树
duànshù
lime



冬青树
dōngqīngshù
holly



浆果
jiāngguǒ
berry

棕榈树
zōnglǔshù
palm



叶
yè
leaf

细枝
xìzhī
twig

树皮
shùpí
bark

树干
shùgàn
trunk



白杨
báiyáng
poplar



柳树
liǔshù
willow



桉树
ānshù
eucalyptus

显花植物 xiǎnhuā zhíwù • flowering plant

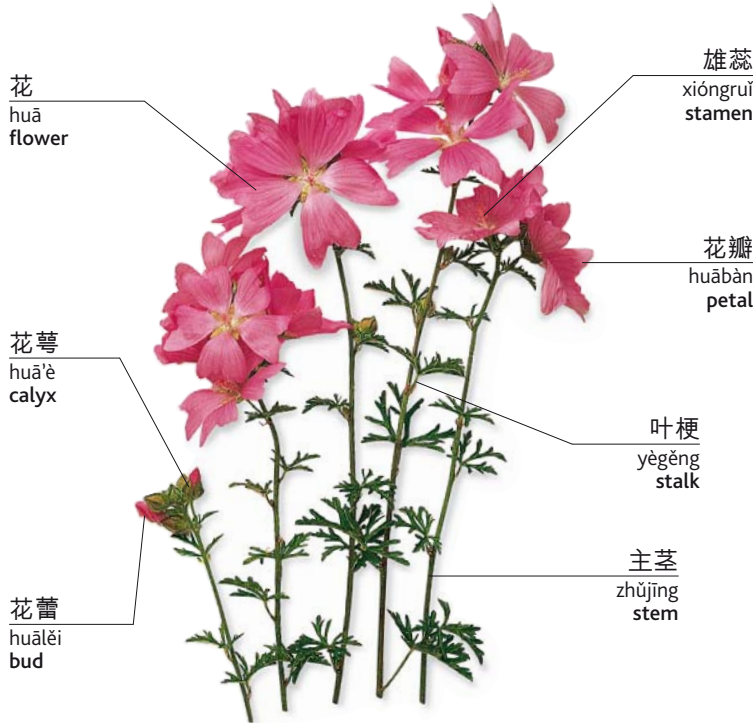

毛茛 máogèn buttercup

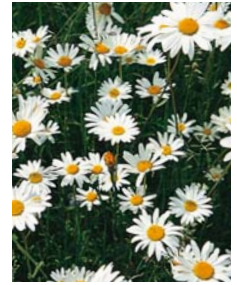

雏菊 chújú daisy



蓟 jì thistle



蒲公英 púgōngyīng dandelion



石南花 shínánhuā heather



罂粟 yīngsù poppy



毛地黄 máodihuáng foxglove



忍冬 rěndōng honeysuckle



向日葵 xiàngrikuí sunflower



苜蓿 mùxu clover



野风信子 yěfēngxinzi bluebells



樱草 yīngcǎo primrose



羽扇豆 yǔshàndòu lupins



荨麻 qiánmá nettle

城镇 chéngzhèn • town



建筑物 jiànzhùwù • buildings



市政厅
shìzhèngtīng
town hall



图书馆
túshūguǎn
library



电影院
diànyǐngyuàn
cinema



剧院
jùyuàn
theatre



大学
dàxué
university



摩天大楼
mótiān dàlóu
skyscraper



学校
xuéxiào
school

区域 qūyù • areas



工业区
gōngyèqū
industrial estate



市区
shìqū
city



郊区
jiāoqū
suburb



村庄
cūnzhuāng
village

词汇 cíhuì • vocabulary

步行区
bùxíngqū
pedestrian zone

小街
xiǎojiē
side street

检修井
jiǎnxiūjǐng
manhole

排水沟
páishuǐgōu
gutter

教堂
jiàotáng
church

林阴道
lín yīng dào
avenue

广场
guǎngchǎng
square

公共汽车站
gōnggòngqìchē zhàn
bus stop

工厂
gōngchǎng
factory

下水道
xiàshuǐdào
drain

建筑 jiànzhù • architecture

建筑与结构 jiànzhù yǔ jiégòu • buildings and structures



摩天大楼
mótiān dàlóu
skyscraper

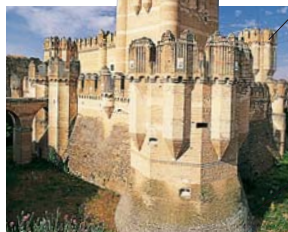

城堡
chéngbǎo
castle



教堂
jiàotáng
church

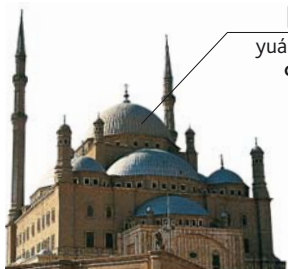

清真寺
qīngzhēnsī
mosque



寺庙
sīmào
temple



犹太教会堂
yóutàijiào huìtáng
synagogue

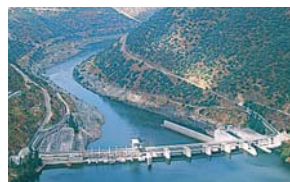

水坝
shuǐbà
dam



桥梁
qiáoliáng
bridge

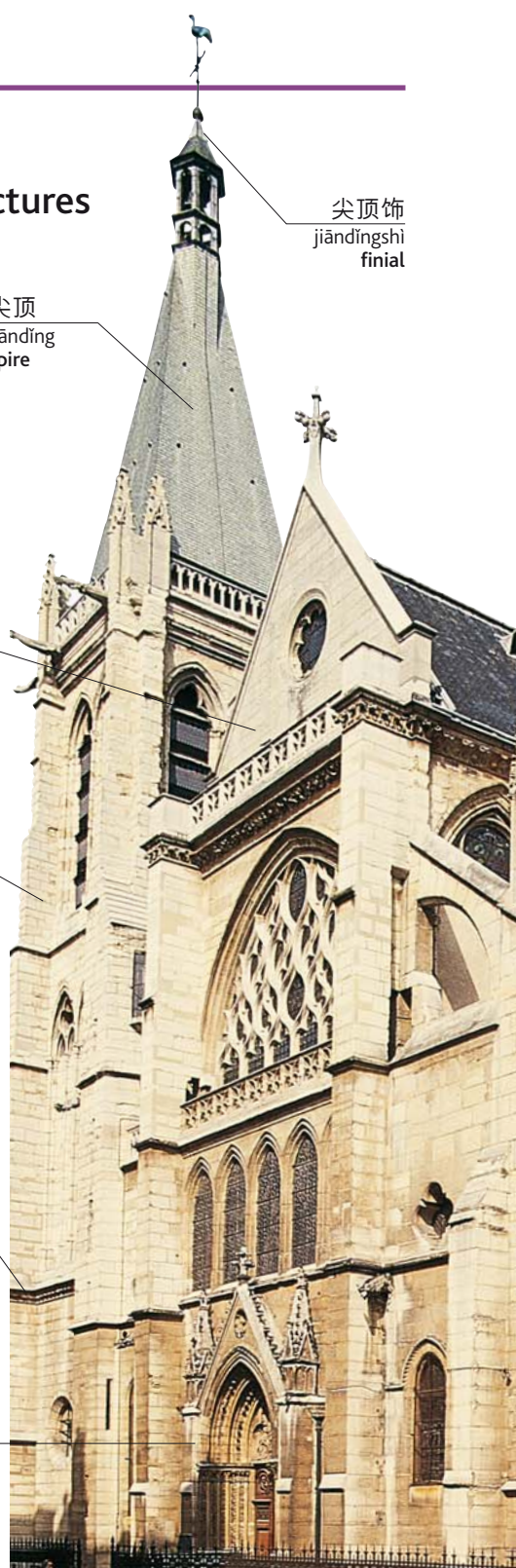

尖顶饰
jiāndǐngshì
finial

角楼 尖顶
jiǎolóu jiāndǐng
turret spire

壕沟
háogōu
moat

三角墙
sānjiǎoqiáng
gable

圆顶
yuándǐng
dome

塔
tǎ
tower

拱型圆顶
gǒngxíng yuándǐng
vault

檐口
yánkǒu
cornice

柱
zhù
pillar

大教堂 dàjiàotáng | cathedral

建筑风格 jiànzhù fēnggé • styles



哥特式 gētèshì | gothic

柱顶楣梁
zhùdǐng méiliáng
architrave



文艺复兴时期风格
wényifùxīng shíqī fēnggé
Renaissance



巴洛克式
bāluòkèshì
baroque

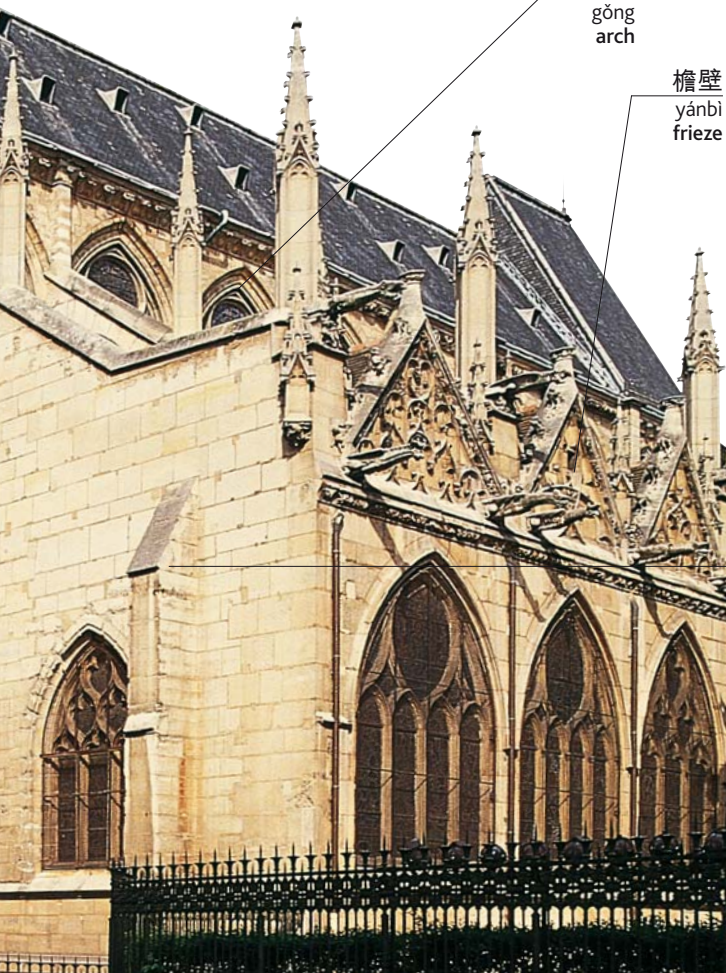

拱
gǒng
arch

檐壁
yánbì
frieze

圣坛
shèngtán
choir

三角楣
sānjiǎoméi
pediment

扶墙
fúqiáng
buttress



洛可可式
luòkěkèshì
rococo



新古典主义风格
xīn gǔdiǎnzhūyì fēnggé
neoclassical

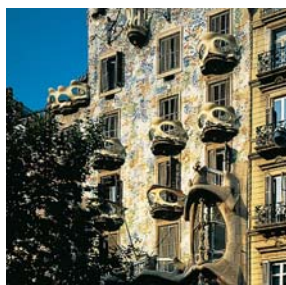

新艺术风格
xīn yìshù fēnggé
art nouveau



装饰艺术风格
zhuāngshìyìshù fēnggé
art deco





日常便览 rìcháng biànlǎn
reference

时间 shíjiān • time

分针
fēnzhēn
minute hand

时针
shízhēn
hour hand



钟表
zhōngbiǎo
clock



一点五分
yīdiǎn wǔ fēn
five past one



一点十分
yīdiǎn shí fēn
ten past one



一点十五分
yīdiǎn shíwǔ fēn
quarter past one



一点二十分
yīdiǎn èrshí fēn
twenty past one



一点二十五分
yīdiǎn èrshíwǔ fēn
twenty five past one

秒针
miǎozhēn
second hand



一点半
yīdiǎnbàn
one thirty



一点三十五分
yīdiǎn sānshíwǔ fēn
twenty five to two



一点四十分
yīdiǎn sìshí fēn
twenty to two



一点四十五分
yīdiǎn sānshíwǔ fēn
quarter to two



一点五十分
yīdiǎn wǔshí fēn
ten to two



一点五十五分
yīdiǎn wǔshíwǔ fēn
five to two



两点钟
liǎngdiǎn zhōng
two o'clock

词汇 cíhuì • vocabulary

秒
miǎo
second

现在
xiànzài
now

一刻钟
yí kèzhōng
a quarter of an hour

分钟
fēnzhōng
minute

以后
yǐhòu
later

二十分钟
èrshí fēnzhōng
twenty minutes

小时
xiǎoshí
hour

半小时
bàn xiǎoshí
half an hour

四十分钟
sìshí fēnzhōng
forty minutes

几点了?
jǐ diǎn le?
What time is it?

三点了。
sāndiǎn le.
It's three o'clock.

昼夜 zhòuyè • night and day



午夜 wǎnyè | midnight



日出 rìchū | sunrise



拂晓 fúxiǎo | dawn



早晨 zǎochén | morning



日落
rìluò
sunset



正午
zhèngwǔ
midday



黄昏 huánghūn | dusk



傍晚 bàngwǎn | evening



下午 xiàwǔ | afternoon

词汇 cíhuì • vocabulary

早
zǎo
early

你来早了。
nǐ lái zǎo le.
You're early.

请准时些。
qǐng zhǔnshí xiē.
Please be on time.

几点结束？
jǐdiǎn jiéshù?
What time does it finish?

准时
zhǔnshí
on time

你迟到了。
nǐ chí dào le.
You're late.

待会儿见。
dài huier jiàn.
I'll see you later.

天晚了。
tiān wǎn le.
It's getting late.

迟
chí
late

我马上就到。
wǒ mǎshàng jiù dào.
I'll be there soon.

几点开始？
jǐdiǎn kāishǐ?
What time does it start?

会持续多久？
huì chíchù duōjiǔ?
How long will it last?

日历 rìlì • calendar

月
yuè
month

年
nián
year

一月
yīyuè
January

2010



日
rì
day

星期一
xīngqīyī
Monday

星期二
xīngqīèr
Tuesday

星期三
xīngqīsān
Wednesday

星期四
xīngqīsì
Thursday

星期五
xīngqīwǔ
Friday

星期六
xīngqīliù
Saturday

星期日
xīngqīrì
Sunday

工作日
gōngzuòrì
work day

1	2	3	4	5	6	7
8	9	10	11	12	13	14
15	16	17	18	19	20	21

星期
xīngqī
week

日期
rìqī
date

昨天
zuótiān
yesterday

今天
jīntiān
today

明天
míngtiān
tomorrow

周末
zhōumò
weekend

词汇 cíhuì • vocabulary

一月
yīyuè
January

三月
sānyuè
March

五月
wǔyuè
May

七月
qīyuè
July

九月
jiǔyuè
September

十一月
shíyīyuè
November

二月
èryuè
February

四月
sìyuè
April

六月
liùyuè
June

八月
bāyuè
August

十月
shíyuè
October

十二月
shíèryuè
December

年 nián • years

1900 一九〇〇年 yījiǔlínglíng nián • nineteen hundred

1901 一九〇一年 yījiǔlíngyī nián • nineteen hundred and one

1910 一九一〇年 yījiǔyīlíng nián • nineteen ten

2000 二〇〇〇年 èrlínglíng nián • two thousand

2001 二〇〇一年 èrlínglíngyī nián • two thousand and one

季节 jìjié • seasons



春天
chūntiān
spring



夏天
xiàtiān
summer



秋天
qiūtiān
autumn



冬天
dōngtiān
winter

词汇 cíhuì • vocabulary

世纪
shìjì
century

本周
běnzhōu
this week

后天
hòutiān
the day after tomorrow

今天几号？
jīntiān jǐhào?
What's the date today?

十年
shínián
decade

上周
shàngzhōu
last week

每周
měizhōu
weekly

今天是二〇〇二年二月七日。
jīntiān shì èrlínglíngèr nián èryuè qīrì.

千年
qiānnián
millennium

下周
xiàzhōu
next week

每月
měiyuè
monthly

It's February seventh, two thousand and two.

两周
liǎngzhōu
fortnight

前天
qiántiān
the day before yesterday

每年
měinián
annual

数字 shùzì • numbers

0 零 líng • zero

1 一 yī • one

2 二 èr • two

3 三 sān • three

4 四 sì • four

5 五 wǔ • five

6 六 liù • six

7 七 qī • seven

8 八 bā • eight

9 九 jiǔ • nine

10 十 shí • ten

11 十一 shíyī • eleven

12 十二 shí'èr • twelve

13 十三 shí sān • thirteen

14 十四 shí sì • fourteen

15 十五 shí wǔ • fifteen

16 十六 shí liù • sixteen

17 十七 shí qī • seventeen

18 十八 shí bā • eighteen

19 十九 shí jiǔ • nineteen

20 二十 èrshí • twenty

21 二十一 èrshíyī • twenty-one

22 二十二 èrshí'èr • twenty-two

30 三十 sānshí • thirty

40 四十 sìshí • forty

50 五十 wǔshí • fifty

60 六十 liùshí • sixty

70 七十 qīshí • seventy

80 八十 bāshí • eighty

90 九十 jiǔshí • ninety

100 一百 yībǎi • one hundred

110 一百一十 yībǎiyíshí • one hundred and ten

200 二百 èrbǎi • two hundred

300 三百 sānbǎi • three hundred

400 四百 sìbǎi • four hundred

500 五百 wǔbǎi • five hundred

600 六百 liùbǎi • six hundred

700 七百 qībǎi • seven hundred

800 八百 bābǎi • eight hundred

900 九百 jiǔbǎi • nine hundred

1000	一千 yīqiān • one thousand
10,000	一万 yīwàn • ten thousand
20,000	两万 liǎngwàn • twenty thousand
50,000	五万 wǔwàn • fifty thousand
55,500	五万五千五百 wǔwàn wǔqiān wǔbǎi • fifty-five thousand five hundred
100,000	十万 shíwàn • one hundred thousand
1,000,000	一百万 yībǎiwàn • one million
1,000,000,000	十亿 shíyì • one billion

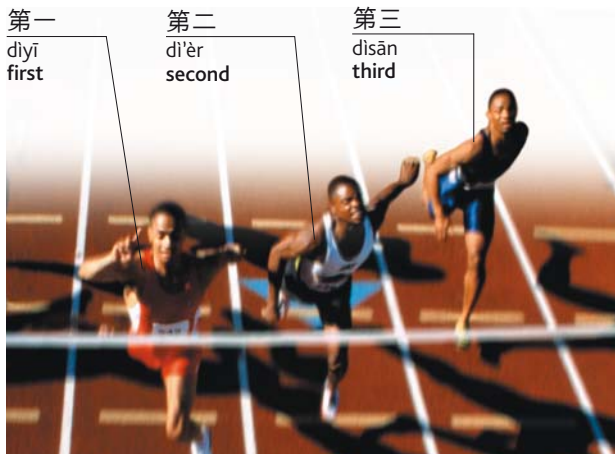

第四 dìsì • fourth

第五 dìwǔ • fifth

第六 dīliù • sixth

第七 dìqī • seventh

第八 dìbā • eighth

第九 dìjiǔ • ninth

第十 dìshí • tenth

第十一 dìshíyī • eleventh

第十二 dìshíèr • twelfth

第十三 dìshísān • thirteenth

第十四 dìshísì • fourteenth

第十五 dìshíwǔ • fifteenth

第十六 dìshíliù •
sixteenth

第十七 dìshíqī •
seventeenth

第十八 dìshíbā •
eighteenth

第十九 dìshíjiǔ •
nineteenth

第二十 dì'èrshí •
twentieth

第二十一 dì'èrshíyī •
twenty-first

第二十二 dì'èrshíèr •
twenty-second

第二十三 dì'èrshísān •
twenty-third

第三十 disānshí • thirtieth

第四十 disìshí • fortieth

第五十 diwǔshí • fiftieth

第六十 dīliùshí • sixtieth

第七十 dìqīshí • seventieth

第八十 dìbāshí • eightieth

第九十 dìjiǔshí • ninetieth

第一百 dìyībǎi • one
hundredth

度量衡 dùliánghéng • weights and measures

面积 miànjī • area

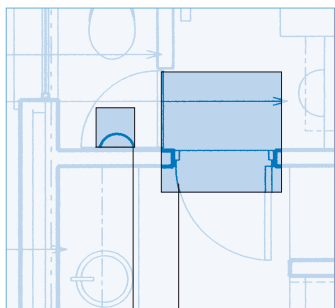

平方英尺
píngfāng yīngchǐ
square foot

平方米
píngfāng mǐ
square metre

距离 jùlí • distance

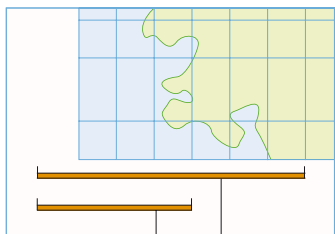

公里
gōnglǐ
kilometre

英里
yīnglǐ
mile

长度 chángdù • length

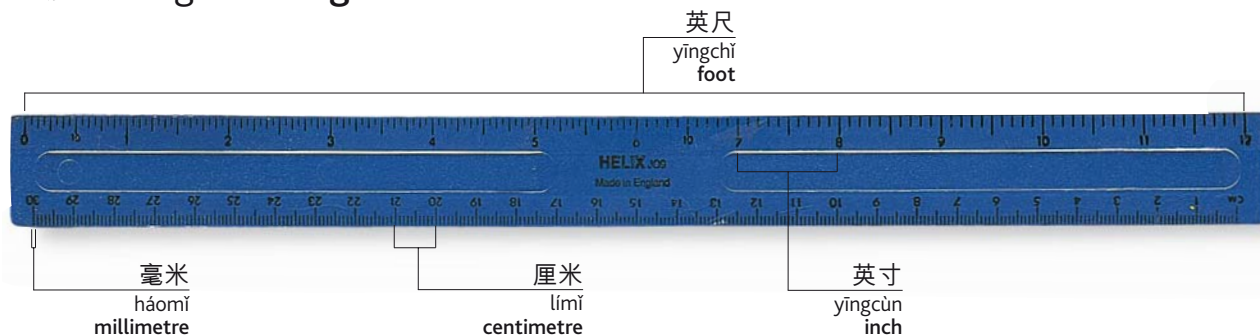

毫米
háomǐ
millimetre

厘米
lí mǐ
centimetre

英寸
yīngcùn
inch

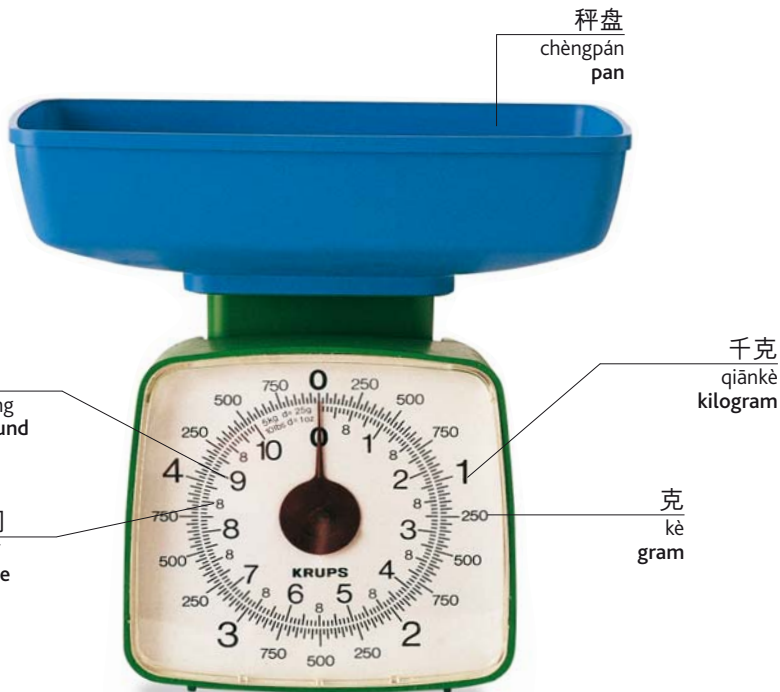

秤盘
chèngpán
pan

磅
bàng
pound

盎司
àngsī
ounce

千克
qiānkè
kilogram

克
kè
gram

磅秤 bàngchèng | scales

词汇 cíhuì • vocabulary

码
mǎ
yard

米
mǐ
metre

吨
dūn
tonne

毫克
háokè
milligram

测量
cèliáng
measure (v)

称重量
chēng zhòngliàng
weigh (v)

容量 róngliàng • capacity

半升
bànshēng
half-litre

品脱
pǐntuō
pint

容积
róngjī
volume

毫升
háoshēng
millilitre



量壶 liànghú | measuring jug



液体量器 yètǐ liàngqì | liquid measure

词汇 cíhuì •
vocabulary

加仑
jiālún
gallon

夸脱
kuātuō
quart

升
shēng
litre

容器 róngqì • container



硬纸盒
yìngzhǐhé
carton



包
bāo
packet



瓶
píng
bottle



袋
dài
bag



塑料盒 sùliàohé | tub



广口瓶 guǎngkǒupíng | jar



罐
guǎn
can

罐头盒 guàntóuhé | tin



喷水器 pēnshuǐqì | liquid dispenser



块
kuài
bar



软管
ruǎnguǎn
tube



卷
juǎn
roll



纸盒
zhǐhé
pack



喷雾罐
pēnwùguǎn
spray can

世界地图 shìjiè dìtú • world map

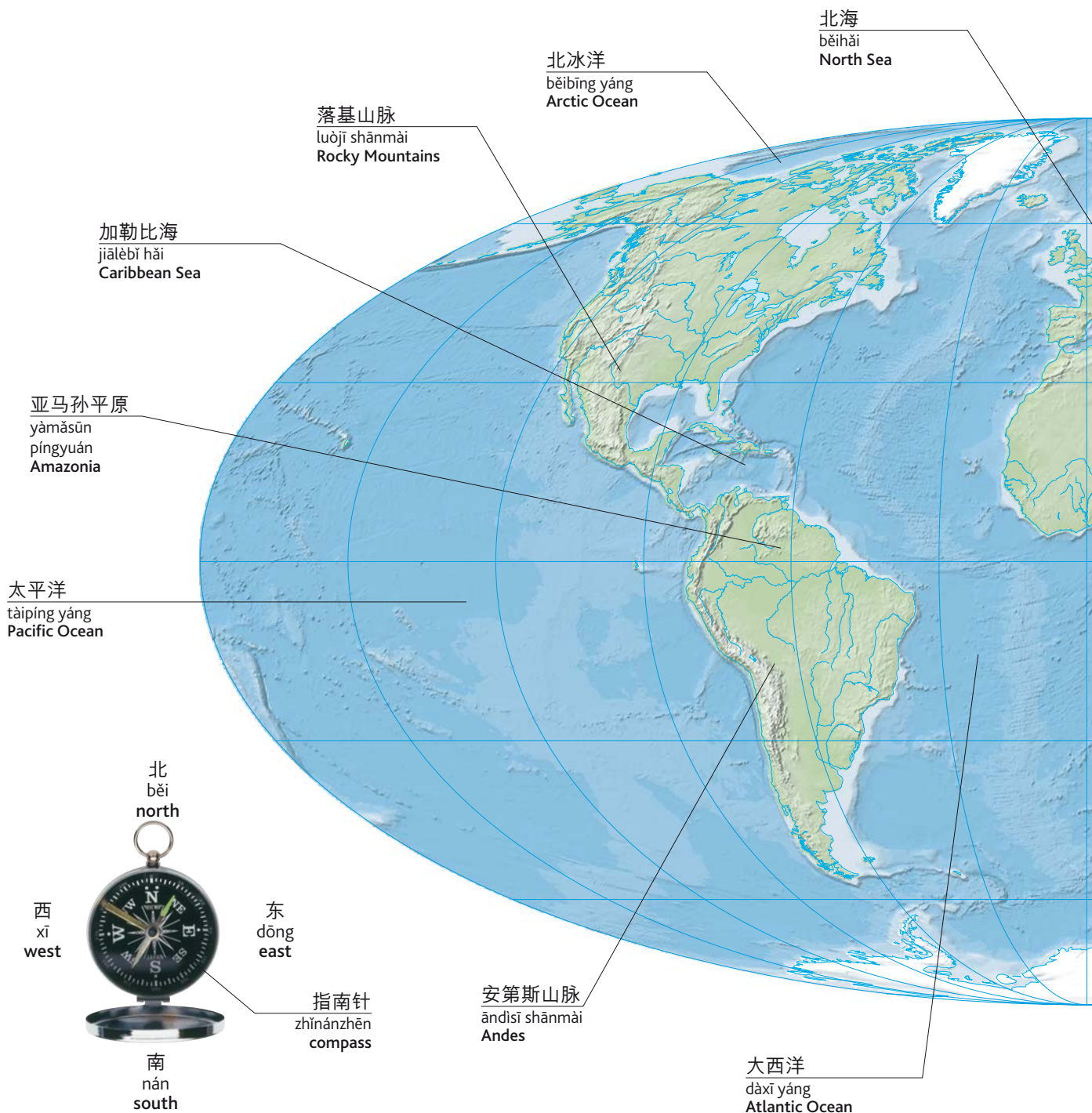

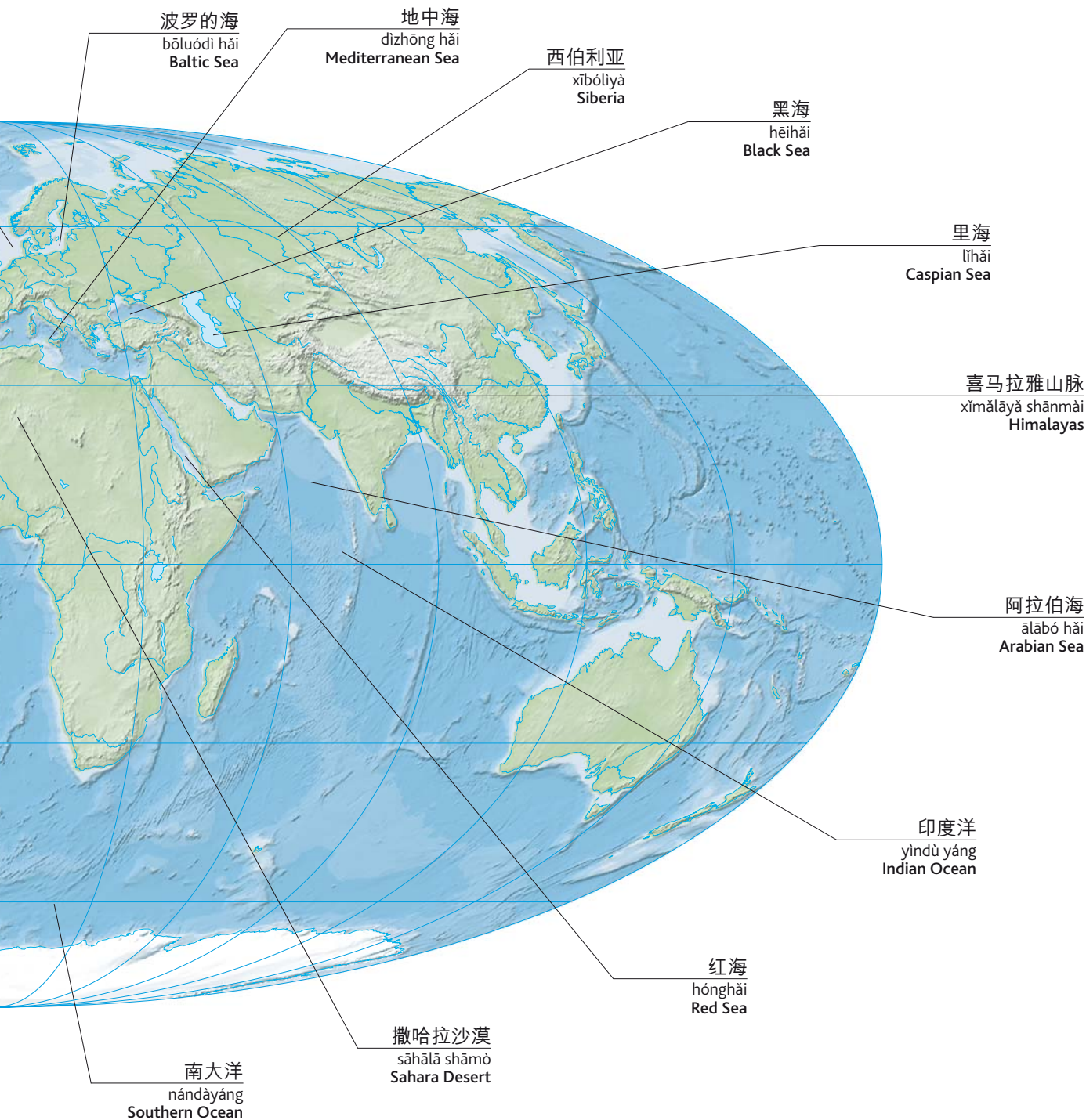

北美洲 běiměizhōu • North and Central America



- 1 阿拉斯加 ālāsījiā • Alaska
- 2 加拿大 jiānádà • Canada
- 3 格陵兰 gélínglǎn • Greenland
- 4 美利坚合众国 měilǐjiānhézhòngguó • United States of America
- 5 墨西哥 mòxīgē • Mexico
- 6 危地马拉 wēidímǎlā • Guatemala
- 7 伯利兹 bólizī • Belize
- 8 萨尔瓦多 sà'ěrwǎduō • El Salvador
- 9 洪都拉斯 hóngdūlāsī • Honduras
- 10 尼加拉瓜 níjiālāguā • Nicaragua
- 11 哥斯达黎加 gēsīdálǐjiā • Costa Rica
- 12 巴拿马 bānámǎ • Panama
- 13 古巴 gǔbā • Cuba
- 14 巴哈马 bāhāmǎ • Bahamas
- 15 牙买加 yámǎijiā • Jamaica
- 16 海地 hǎidi • Haiti
- 17 多米尼加 duōmīnjīā • Dominican Republic
- 18 波多黎各 bōduōlígè • Puerto Rico
- 19 巴巴多斯 bābādūōsī • Barbados
- 20 特立尼达和多巴哥 tèlínídà hé duōbāgē • Trinidad and Tobago
- 21 圣基茨和尼维斯 shèngjīcí hé níwéisi • St. Kitts and Nevis
- 22 安提瓜和巴布达 āntígūā hé bābúdà • Antigua and Barbuda
- 23 多米尼克 duōmīnikè • Dominica
- 24 圣卢西亚 shènglúxīyà • St Lucia
- 25 圣文森特和格林纳丁斯 shèngwénsèntè hé gélínnàdīngsī • St Vincent and The Grenadines
- 26 格林纳达 gélínnàdà • Grenada

南美洲 nánměizhōu • South America



- 1 委内瑞拉 wēinèiruīlā • Venezuela
- 2 哥伦比亚 gēlúnbiyà • Colombia
- 3 厄瓜多尔 èguāduōěr • Ecuador
- 4 秘鲁 bìlǔ • Peru
- 5 加拉帕戈斯群岛 jiālāpàgēsī qúndǎo
• Galapagos Islands
- 6 圭亚那 guīyànà • Guyana
- 7 苏里南 sūlínán • Suriname
- 8 法属圭亚那 fǎshǔ guīyànà •
French Guiana
- 9 巴西 bāxī • Brazil
- 10 玻利维亚 bōlīwéiyà • Bolivia
- 11 智利 zhìlì • Chile
- 12 阿根廷 āgēntíng • Argentina
- 13 巴拉圭 bālāguī • Paraguay
- 14 乌拉圭 wūlāguī • Uruguay
- 15 福克兰群岛 (马尔维纳斯群岛) fúkèlán
qúndǎo (mǎěrwéinàsī qúndǎo) • Falkland Islands

词汇 cíhuì • vocabulary

国家 guójiā country	省 shěng province	地域 dìyù zone
民族 mínzú nation	领土 lǐngtǔ territory	行政区 xíngzhèngqū district
大陆 dàlù continent	殖民地 zhīmíndì colony	地区 dìqū region
主权国家 zhǔquán guójiā state	公国 gōngguó principality	首都 shǒudū capital

欧洲 ōuzhōu • Europe

- | | | |
|---|-----------------------------------|---|
| 1 爱尔兰 ài'ěrlán • Ireland | 30 梵蒂冈 fàndìgāng • Vatican City | 41 塞尔维亚 sài'ěrweiyà • Serbia |
| 2 英国 yīngguó • United Kingdom | 31 西西里岛 xīxīlǐdǎo • Sicily | 42 波斯尼亚和黑塞哥维那(波黑) bōsīniyà hé hēisàigēwéinà(bōhēi) • Bosnia and Herzegovina |
| 3 葡萄牙 pútáoyá • Portugal | 32 马耳他 mǎ'ěrtā • Malta | 43 阿尔巴尼亚 ā'ěrbāniyà • Albania |
| 4 西班牙 xībānyá • Spain | 33 斯洛文尼亚 sīluòwénni yà • Slovenia | 44 马其顿 mǎqí dùn • Macedonia |
| 5 巴利阿里群岛 bālǎlǐ qúndǎo • Balearic Islands | 34 克罗地亚 kèluódi yà • Croatia | 45 保加利亚 bǎojiāli yà • Bulgaria |
| 6 安道尔 āndào'ěr • Andorra | 35 匈牙利 xiōngyá lì • Hungary | 46 希腊 xīlà • Greece |
| 7 法国 fǎguó • France | 36 斯洛伐克 sīluòfákè • Slovakia | 47 土耳其 tǔ'ěr qí • Turkey |
| 8 比利时 bīlìshí • Belgium | 37 乌克兰 wūkèlán • Ukraine | 48 塞浦路斯 sàipǔlùsī • Cyprus |
| 9 荷兰 hélán • Netherlands | 38 白俄罗斯 bái'élúosī • Belarus | 49 黑山 hēishān • Montenegro |
| 10 卢森堡 lúsēnbǎo • Luxembourg | 39 摩尔多瓦 mó'ěrduōwǎ • Moldova | |
| 11 德国 déguó • Germany | 40 罗马尼亚 luómǎni yà • Romania | |
| 12 丹麦 dānmài • Denmark | | |
| 13 挪威 nuówēi • Norway | | |
| 14 瑞典 ruidiǎn • Sweden | | |
| 15 芬兰 fēnlán • Finland | | |
| 16 爱沙尼亚 àishā'ni yà • Estonia | | |
| 17 拉脱维亚 lātuōwéiyà • Latvia | | |
| 18 立陶宛 lìtáowǎn • Lithuania | | |
| 19 加里宁格勒 jiālǐnínggèlè • Kaliningrad | | |
| 20 波兰 bōlán • Poland | | |
| 21 捷克 jiékè • Czech Republic | | |
| 22 奥地利 àodìlì • Austria | | |
| 23 列支敦士登 lièzhīdūnshìdēng • Liechtenstein | | |
| 24 瑞士 ruìshì • Switzerland | | |
| 25 意大利 yìdàlì • Italy | | |
| 26 摩纳哥 mónàgē • Monaco | | |
| 27 科西嘉岛 kēxījiādǎo • Corsica | | |
| 28 撒丁岛 sādīngdǎo • Sardinia | | |
| 29 圣马力诺 shèngmǎlǐnuò • San Marino | | |

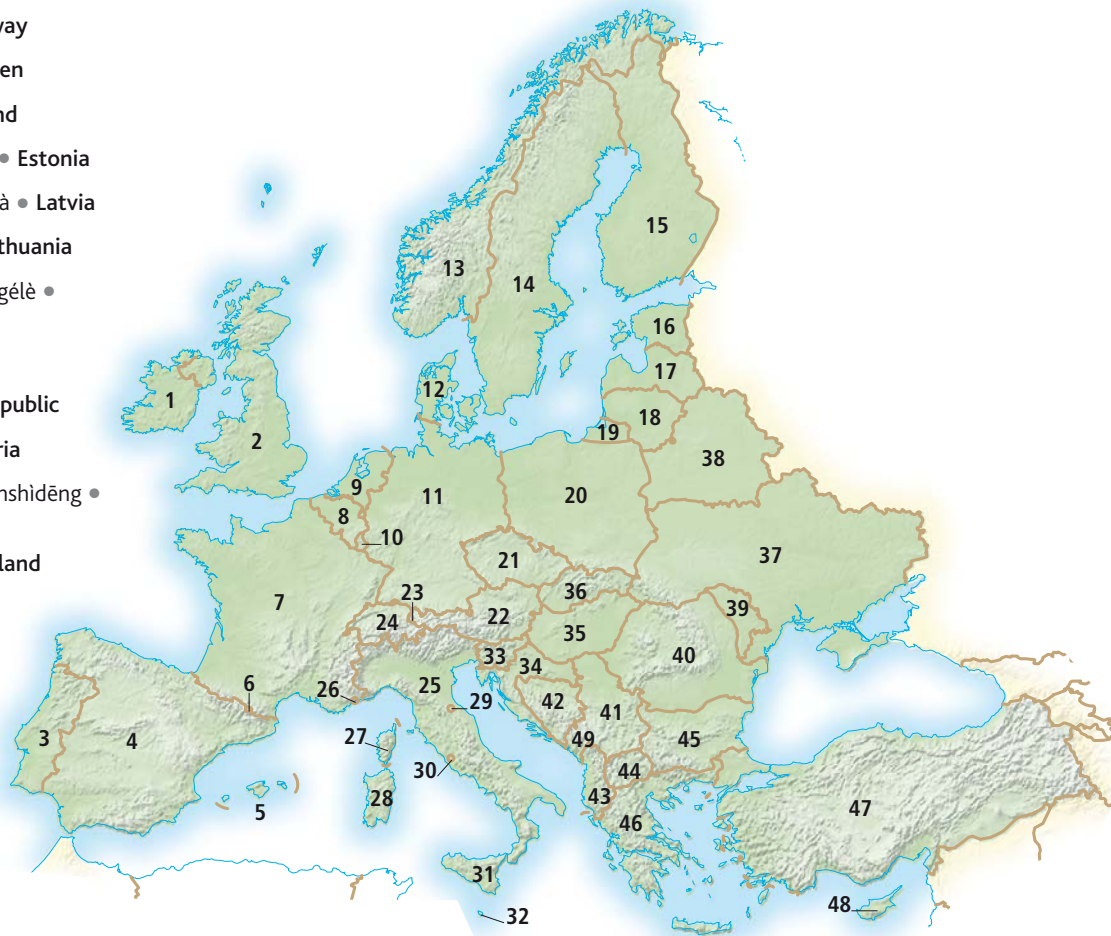

非洲 fēizhōu • Africa

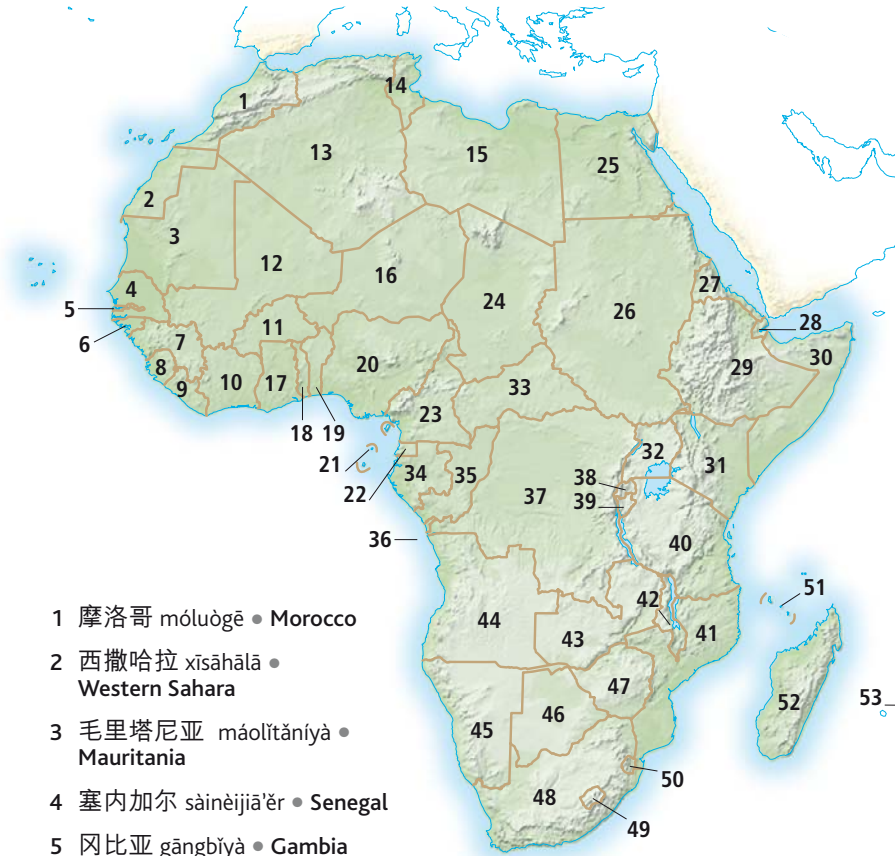

- 1 摩洛哥 móluògē • Morocco
- 2 西撒哈拉 xīsāhālā • Western Sahara
- 3 毛里塔尼亚 máolìtǎniyà • Mauritania
- 4 塞内加尔 sàinèijǐā'ěr • Senegal
- 5 冈比亚 gāngbǐyà • Gambia
- 6 几内亚比绍 jǐ'nèiyà bǐshào • Guinea-Bissau
- 7 几内亚 jǐ'nèiyà • Guinea
- 8 塞拉利昂 sàilālǎng • Sierra Leone
- 9 利比里亚 libǐlǐyà • Liberia
- 10 科特迪瓦 kētédíwǎ • Ivory Coast
- 11 布基纳法索 bùjīnà fǎsuǒ • Burkina Faso
- 12 马里 mǎlǐ • Mali
- 13 阿尔及利亚 ā'ěrjǐlǐyà • Algeria
- 14 突尼斯 túnísì • Tunisia
- 15 利比亚 libǐyà • Libya
- 16 尼日尔 nírì'ěr • Niger
- 17 加纳 jiānà • Ghana
- 18 多哥 duōgē • Togo
- 19 贝宁 bèining • Benin

- 20 尼日利亚 nírìlǐyà • Nigeria
- 21 圣多美和普林西比 shèngduōmèi hé pǔlǐnxībǐ • São Tomé and Príncipe
- 22 赤道几内亚 chìdàojǐnèiyà • Equatorial Guinea
- 23 喀麦隆 kāmàilóng • Cameroon
- 24 乍得 zhàdé • Chad
- 25 埃及 āiji • Egypt
- 26 苏丹 sūdān • Sudan
- 27 厄立特里亚 èlìtèlǐyà • Eritrea
- 28 吉布提 jíbútí • Djibouti
- 29 埃塞俄比亚 āisà'èbǐyà • Ethiopia
- 30 索马里 suǒmǎlǐ • Somalia
- 31 肯尼亚 kěnni'yà • Kenya

- 32 乌干达 wūgāndá • Uganda
- 33 中非共和国 zhōngfēi gònghéguó • Central African Republic
- 34 加蓬 jiāpéng • Gabon
- 35 刚果 gāngguǒ • Congo
- 36 卡奔达(安哥拉) kābēndá(āngēlā) • Cabinda
- 37 刚果民主共和国 gāngguǒ mǐnzhǔ gònghéguó • Democratic Republic of the Congo
- 38 卢旺达 lúwàngdá • Rwanda
- 39 布隆迪 bùlóngdí • Burundi
- 40 坦桑尼亚 tǎnsāngniyà • Tanzania
- 41 莫桑比克 mòsāngbìkè • Mozambique
- 42 马拉维 mǎlāwéi • Malawi
- 43 赞比亚 zànbǐyà • Zambia
- 44 安哥拉 āngēlā • Angola
- 45 纳米比亚 nànmǐbǐyà • Namibia
- 46 博茨瓦纳 bócíwǎnà • Botswana
- 47 津巴布韦 jīnbābùwéi • Zimbabwe
- 48 南非 nánfēi • South Africa
- 49 莱索托 láisuǒtuō • Lesotho
- 50 斯威士兰 sīwēishìlán • Swaziland
- 51 科摩罗群岛 kēmóluóqúndǎo • Comoros
- 52 马达加斯加 mǎdǎjiāsījiā • Madagascar
- 53 毛里求斯 máolǐqiú'sī • Mauritius

亚洲 yàzhōu • Asia

- 1 俄罗斯联邦 éluósīliánbāng • Russian Federation
- 2 格鲁吉亚 gēlǔjǐyà • Georgia
- 3 亚美尼亚 yàměiniyà • Armenia
- 4 阿塞拜疆 ā'sàibàijiāng • Azerbaijan
- 5 伊朗 yīlǎng • Iran
- 6 伊拉克 yīlākè • Iraq
- 7 叙利亚 xùliyà • Syria
- 8 黎巴嫩 líbānèn • Lebanon
- 9 以色列 yǐsèliè • Israel
- 10 约旦 yuēdàn • Jordan
- 11 沙特阿拉伯 shàtè'ālábó • Saudi Arabia
- 12 科威特 kēwēitè • Kuwait
- 13 卡塔尔 kätā'ěr • Qatar
- 14 阿拉伯联合酋长国 ālábó liánhé qiúzhǎngguó • United Arab Emirates
- 15 阿曼 āmàn • Oman
- 16 也门 yěmén • Yemen
- 17 哈萨克斯坦 hāsàkèsītǎn • Kazakhstan
- 18 乌兹别克斯坦 wūzǐbiékèsītǎn • Uzbekistan
- 19 土库曼斯坦 tǔkùmànsītǎn • Turkmenistan
- 20 阿富汗 āfùhàn • Afghanistan
- 21 塔吉克斯坦 tājǐkèsītǎn • Tajikistan
- 22 吉尔吉斯斯坦 jǐěrgǐsītǎn • Kyrgyzstan
- 23 巴基斯坦 bājǐsītǎn • Pakistan
- 24 印度 yīndù • India
- 25 马尔代夫 mǎ'ěrdàifū • Maldives
- 26 斯里兰卡 sīlǐlánkǎ • Sri Lanka
- 27 中国 zhōngguó • China
- 28 蒙古 měnggǔ • Mongolia
- 29 朝鲜 cháoxiǎn • North Korea
- 30 韩国 hángguó • South Korea
- 31 日本 rìběn • Japan
- 32 尼泊尔 níbó'ěr • Nepal
- 33 不丹 bùdān • Bhutan
- 34 孟加拉国 mèngjiālǎguó • Bangladesh



- 35 缅甸 miǎndiàn • Burma (Myanmar)
- 36 泰国 tàiguó • Thailand
- 37 老挝 lǎowō • Laos
- 38 越南 yuènnán • Viet Nam
- 39 柬埔寨 jiǎnpǔzhài • Cambodia
- 40 马来西亚 mǎlǎixīyà • Malaysia
- 41 新加坡 xīnjiāpō • Singapore

大洋洲 dàiyángzhōu • Australasia



- 1 澳大利亚 àodàliyà • Australia
- 2 塔斯马尼亚(岛) tāsīmǎniyà(dǎo) • Tasmania
- 3 新西兰 xīnxīlán • New Zealand

42 印度尼西亚 yīndùnìxīyà • Indonesia

43 文莱 wénlái • Brunei

44 菲律宾 fēilǚbīn • Philippines

45 东帝汶 dōngdìwèn • East Timor

46 巴布亚新几内亚 bābùyà xīnjīnèiyà • Papua New Guinea

47 所罗门群岛 suǒluómén qúndǎo • Solomon Islands

48 瓦努阿图 wǎnūātú • Vanuatu

49 斐济 fěiji • Fiji

小品词与反义词 xiǎopǐncí yǔ fǎnyìcí • particles and antonyms

到...去 dào...qù to	从...来 cóng...lái from	为 wèi for	向...方向 xiàng...fāngxiàng towards
在...上方 zài...shàngfāng over	在...下方 zài...xiàfāng under	沿着... yánzhe... along	越过 yuèguò across
在...前面 zài...qiánmian in front of	在...后面 zài...hòumian behind	连同 liántóng with	没有... méiyǒu... without
在...上 zài...shàng onto	到...里 dào...lǐ into	在...之前 zài...zhīqián before	在...之后 zài...zhīhòu after
在...里 zài...lǐ in	在...外 zài...wài out	不迟于... bùchíyú... by	直到... zhídào... until
在...上面 zài...shàngmian above	在...下面 zài...xiàmian below	早 zǎo early	迟 chí late
在...里面 zài...lǐmian inside	在...外面 zài...wàimiàn outside	现在 xiànzài now	以后 yǐhòu later
向上 xiàngshàng up	向下 xiàngxià down	一直 yìzhí always	从不 cóngbù never
在 zài at	超出 chāochū beyond	经常 jīngcháng often	很少 hěnshǎo rarely
穿越 chuānyuè through	在...周围 zài...zhōuwéi around	昨天 zuótiān yesterday	明天 míngtiān tomorrow
在...之上 zài...zhīshàng on top of	在...旁边 zài...pángbiān beside	第一 dìyī first	最后 zuìhòu last
在...之间 zài...zhījiān between	在...对面 zài...duìmian opposite	每... měi... every	一些 yìxiē some
在...附近 zài...fùjìn near	离...远 lí...yuǎn far	关于 guānyú about	准确地 zhǔnquèdì exactly
这里 zhèlǐ here	那里 nàlǐ there	一点儿 yìdiǎn'er a little	很多 hěnduō a lot

大 dà large	小 xiǎo small	热 rè hot	冷 lěng cold
宽 kuān wide	窄 zhǎi narrow	开 kāi open	关 guān closed
高大 gāodà tall	矮小 ǎixiǎo short	满 mǎn full	空 kōng empty
高 gāo high	低 dī low	新 xīn new	旧 jiù old
厚 hòu thick	瘦 shòu thin	轻 qīng light	黑暗 hēiàn dark
轻 qīng light	重 zhòng heavy	容易 róngyì easy	困难 kùnnán difficult
硬 yìng hard	软 ruǎn soft	空闲 kòngxián free	忙碌 mánglù occupied
潮湿 cháoshī wet	干燥 gānzào dry	强壮 qiángzhuàng strong	虚弱 xūruò weak
好 hǎo good	坏 huài bad	胖 pàng fat	瘦 shòu thin
快 kuài fast	慢 màn slow	年轻 niánqīng young	年老 niánlǎo old
正确 zhèngquè correct	错误 cuòwù wrong	更好 gènghǎo better	更差 gèngchà worse
干净 gānjìng clean	脏 zāng dirty	黑色 hēisè black	白色 báisè white
好看 hǎokàn beautiful	丑 chǒu ugly	有趣 yǒuqù interesting	厌恶 yànwù boring
贵 guì expensive	便宜 piányi cheap	生病的 shēngbìngde sick	健康的 jiànkāngde well
安静 ānjìng quiet	吵闹 chǎonào noisy	开始 kāishǐ beginning	结束 jiéshù end

常用语 cháng yòngyǔ • useful phrases

基本用语 jīběn yòngyǔ • essential phrases

是
shì
Yes

不
bù
No

也许
yěxǔ
Maybe

请
qǐng
Please

谢谢
xièxiè
Thank you

不用谢
bùyòngxiè
You're welcome

抱歉；打扰一下
bàoqiàn, dǎrǎoyíxià
Excuse me

对不起
duìbuqǐ
I'm sorry

不要
búyào
Don't

好
hǎo
OK

很好
hěnhǎo
That's fine

正确
zhèngquè
That's correct

不对
búduì
That's wrong

问候 wèn hòu •
greetings

你好
nǐ hǎo
Hello

再见
zàijiàn
Goodbye

早上好
zǎoshang hǎo
Good morning

下午好
xiàwǔ hǎo
Good afternoon

晚上好
wǎnshang hǎo
Good evening

晚安
wǎn'ān
Good night

你好吗？
nǐ hǎo ma?
How are you?

我叫...
wǒ jiào...
My name is...

您怎么称呼？
nín zěnmē chēnghū?
What is your name?

他/她叫什么名字？
tā/tā jiào shénme míngzì?
What is his/her name?

我介绍一下...
wǒ jièshào yíxià...
May I introduce...

这是...
zhèshì...
This is...

很高兴见到你
hènggāoxìng jiàndào nǐ
Pleased to meet you

待会儿见
dài huì'er jiàn
See you later

标志 biāozhì • signs

游客问询处
yóukè wèn xún chù
Tourist information

入口
rùkǒu
Entrance

出口
chūkǒu
Exit

紧急出口
jǐnjí chūkǒu
Emergency exit

推
tuī
Push

危险
wēixiǎn
Danger

禁止吸烟
jìnzhǐ xī yān
No smoking

故障
gùzhàng
Out of order

开放时间
kāifàng shíjiān
Opening times

免费入场
miǎnfèi rùchǎng
Free admission

全天开放
quántiān kāifàng
Open all day

减价
jiǎnjià
Reduced price

打折
dǎshé
Sale

进前敲门
jìnqiánqiāomén
Knock before entering

禁止践踏草坪
jìnzhǐ jiàntàcǎopíng
Keep off the grass

求助 qiúzhù • help

你能帮帮我吗？
nǐ néng bāngbāng wǒ ma?
Can you help me?

我不懂
wǒ bù dǒng
I don't understand

我不知道
wǒ bù zhīdào
I don't know

你说英语吗？
nǐ shuō yīngyǔ ma?
Do you speak English?

你说中文吗？
nǐ shuō zhōngwén ma?
Do you speak Chinese?

我会说英语
wǒ huì shuō yīngyǔ
I speak English

我会说西班牙语
wǒ huì shuō xībānyáyǔ
I speak Spanish

请说得再慢些
qǐng shuōdé zài màn xiē
Please speak more slowly

请帮我写下来
qǐng bāng wǒ xiě xiàlá
Please write it down for me

我丢了...
wǒ diūle...
I have lost...

方向 fāngxiàng •
directions

我迷路了
wǒ mílùle
I am lost

...在哪里?
zàinǎli
Where is the...?

最近的...在哪里?
zuijinde...zàinǎli?
Where is the nearest...?

洗手间在哪儿?
xǐshǒujiān zàinǎer?
Where are the toilets?

我怎么去...?
wǒ zěnmē qù...?
How do I get to...?

右转
yòuzhuǎn
To the right

左转
zuǒzhuǎn
To the left

向前直行
xiàngqián zhíháng
Straight ahead

到...有多远?
wǒ zěnmē qù...?
How far is...?

交通标志 jiāotōng
biāozhì • road signs

各方通行
gēfāng tōngxíng
All directions

谨慎驾驶
jǐnshèn jiàshǐ
Caution

禁入
jìnrù
No entry

减速
jiǎnsù
Slow down

绕行
ràoxíng
Diversion

靠右行驶
kào yòucè xíngshǐ
Keep to the right

高速公路
gāosùgōnglù
Motorway

禁止停车
jìnzhǐ tíngchē
No parking

禁止通行
jìnzhǐ tōngxíng
No through road

单行道
dānxíngdào
One-way street

其他方向通行
qítāfāngxiàng tōngxíng
Other directions

只限本区居民(停车)
zhǐxiànběnrūjūmín (tíngchē)
Residents only

道路管制
dàolùguǎnzhì
Roadworks

危险弯道
wēixiǎnwāndào
Dangerous bend

住宿 zhùsù •
accommodation

我订了房间
wǒ dīng le fángjiān
I have a reservation

餐厅在哪儿?
cāntīng zàinǎ'er
Where is the dining room?

我的房间号是...
wǒ de fángjiān hào shì...
My room number is ...

几点吃早餐?
jǐdiǎn chī zǎocān?
What time is breakfast?

我将在...点回来
wǒ jiāng zài...diǎn huílái
I'll be back at ... o'clock

我明天离开
wǒ míngtiān líkāi
I'm leaving tomorrow

饮食 yǐnshí • eating
and drinking

干杯!
gānbēi
Cheers!

好吃极了
hàochíjǐle
It's delicious

难吃死了
nánchīsǐle
It's awful

我不喝酒
wǒ bù hējiǔ
I don't drink

我不抽烟
wǒ bù chōuyān
I don't smoke

我不吃肉
wǒ bù chīròu
I don't eat meat

够了, 谢谢
gòule, xièxiè
No more for me,
thank you

请再来点儿
qǐng zàilái diǎn'er
May I have some more?

我们要结账
wǒmen yào jiézhàng
May we have the
bill?

请开张收据
qǐng kāi zhāng shōujù
Can I have a receipt?

禁烟区
jìnyānqū
No-smoking area

健康 jiànkāng • health

我不舒服
wǒ bù shūfu
I don't feel well

我难受
wǒ nánshòu
I feel sick

离这儿最近的医生
电话是多少?
lí zhè'er zuìjìn de yīshēng
diànhuà shì duōshǎo?
What is the telephone
number of the nearest
doctor?

我这儿疼
wǒ zhè'er téng
It hurts here

我发烧了
wǒ fāshāole
I have a temperature

我怀孕...个月了
wǒ huáiyùn...gè yuèle
I'm ... months pregnant

我需要...处方
wǒ xūyào...chǔfāng
I need a prescription for ...

我通常服用...
wǒ tōngcháng fúyòng...
I normally take ...

我对...过敏
wǒ duì...guòmǐn
I'm allergic to ...

他好吗?
tā hǎoma?
Will he be all right?

她好吗?
tā hǎoma?
Will she be all right?

中文索引 zhōngwén suǒyǐn • Chinese index

A

ā'erbānyà 316
 ā'ěrjǐliǎ 317
 ā'sàibàijiāng 318
 āfùhàn 318
 āgēntíng 315
 ài 287
 ài'ěrǎn 316
 àiji 317
 àiqíngpiān 255
 àisàil'ébìyà 317
 àishā'nìyà 316
 àixiǎo 321
 ālābó hái 313
 ālābó liánhé qiúzhàngguó 318
 ālāsījī 314
 àmàn 318
 àn càidán diǎncài 152
 ànbǎn 68
 ànbǐānlánzhuāng 214
 ānchún 119
 ānchúndǎn 137
 āndào'ěr 316
 āndǎsī shānmài 312
 āngēlā 317
 àngsī 310
 ànjiànnqū 97, 99
 ānjīng 321
 ānkāngyú 120
 ànmǎ 235
 ànmiányào 109
 ànmó 54
 ànpéi 60
 ānquán 75, 212
 ānquán biézhen 47
 ānquán dàohúlán 298
 ānquán zuàntóu 80
 ānquándài 198, 211
 ānquánhúlán 246
 ānquánmào 186
 ānquánqínáng 201
 ānquánshànglèi 228
 ànshì 271
 ānshù 296
 āntígú hé bābúdà 174
 ānzhuāng 177
 ānzuó 242
 àodàliǎyà 319
 àodìlì 316
 àozhōujiānguó 129

B

B chāo 52
 bà 249
 bā 308
 bǎ...zhòng yú pénnèi 91
 bābāduōsī 314
 bābǎi 308
 bābiānxíng 164
 bābúyà xīnjīnèiyà 319
 bāhāmǎ 314
 bái(pútáojiù) 145
 bái'è 288

bái'élúosī 316
 báicùlì 127
 bāifēnbí 165
 báigānlǎo 136
 báigé 272
 bāihé 110
 bǎihuò shāngdiàn 105
 bǎijǐbǐng 139
 bǎikēquánshù 163
 bǎilándì 145
 bǎilìxiāng 133
 bǎimǐ 130
 bǎimiànbào 139
 bǎinèizhàng 51
 bǎiqiǎokèlì 113
 bǎiróu 118
 bǎisè 39, 274, 321
 bǎiyáng 296
 bǎiyēchuāng 58, 63
 bǎiyí 295
 bǎiyóulùmiàn 187
 bǎizhuōzǐ 64
 bǎijiǎo 133
 bǎijǐsītān 318
 bǎlāgū 315
 bǎlèiwú 255
 bǎlèiwúqún 191
 bǎllǎlǎ qúndǎo 316
 bǎluòkèshì 301
 bǎn xiāoshí 304
 bǎnāmǎ 314
 bǎnbiān 246
 bǎnchǎng 223
 bǎnchē 197
 bǎndǎo 282
 bǎndòu 131
 bǎndúlìshì 58
 bàng 310
 bàngbàngtáng 113
 bàngchèng 310
 bànggēgū 257
 bàngōngtóu 298
 bàngōngshèbèi 172
 bàngōngshì 24, 172, 174
 bàngōngyòngpǐn 173
 bàngōngzhuó 172
 bàngqiú 228
 bàngqiú shòutào 228
 bàngwǎn 305
 bàngxíng niúkòu 31
 bǎnhuà 275
 bǎnjī 210, 212
 bǎnjiān 246
 bǎnjīng 164
 bǎnkuài 283
 bǎnlǐ dēngjī shǒuxù 212
 bǎnlǐ dēngjī shǒuxùchù 213
 bǎnlídòu 131
 bǎnmǎ 291
 bǎnqián 81
 bǎnqiú 225
 bǎnqiú qiúyuán 225
 bǎnrúnnǎilào 136

bànsǎng 311
 bànsǎshù 101
 bànsǎshou 80
 bàntuōzhǐ niúnnǎi 136
 bànyán 288
 bànyīngnǎilào 136
 bǎnyúngōng 100
 báo 321
 báo 37, 311
 báo 64
 báoōn 189
 báoōngjuǎn 155
 báoōucuibīnggān 139, 156
 báoōcún 177
 báoōfēngyú 287
 báoōgāncuibīng 139
 báoōgào 174
 báoōguāngbiào 270
 báoōguāngjī shùqǐ 270
 báoōguó 99
 báoōhuā 78
 báoōhuābǎn 79
 báoōjiǎliǎyà 316
 báoōjiānbǐng 157
 báoōjiāojiāng 83
 báoōkǎntíng 112
 báoōlíngqiú 249
 báoōlíngqiú píng 249
 báoōlíngqiú yùndòng 249
 báoōmíhuà 255
 báoōnuǎn nèiyī 267
 báoōpǐ 21
 báoōpiàn 119
 báoōpiqiǎn 81
 báoōshí 36, 288
 báoōshìjīn 181
 báoōshìshuāng 41
 báoōtāi 203, 207
 báoōwēnpíng 267
 báoōxián 203
 báoōxiāng 254
 báoōxiāngàng 198
 báoōxiānhé 60, 203
 báoōxiǎnsī 60
 báoōzǎ 47
 báoōzhǐ 112
 báoōzhuāngzhǐ 111
 báoōzi 81
 báoōzīgǎnlán 123
 bǎpán 273
 básāizhuàn 150
 bāshí 308
 bāshou 88
 bāsōngguǎn 257
 bātái 150
 bāxi 315
 bāxiuguó 129
 bāxīn 273
 báyá 50
 bāyue 306
 bèi 13, 165
 bèi 312
 bèibànqiú 283

bèibào 31, 37, 267
 bèibīng yáng 312
 bèidài 37
 bèidiàn 150
 bèidiyinguān 257
 bèigāo 180
 bèigàorén 181
 bèihǎi 312
 bèihuīgūxiàn 283
 bèiji 283
 bèiji xióng 291
 bèijīngmùbù 254
 bèijiquān 283
 bèikè 265
 bèikuòjǐ 16
 bèimèizhōu 314
 bèining 317
 bèiqi 294
 bèirù 74
 bèishāng 25
 bèishuā 73
 bèiwànglù 173
 bèixin 30, 33, 35, 250
 bèiyòng lúntāi 203
 bèncǎo liáofá 55
 bèngdài 47
 bèngjí 248
 běnléi 228
 běnshēngdēng 166
 běnwèihào 256
 běnzhōu 307
 biāncái 220, 223, 230
 biānfú 290
 biānjí 191
 biānjiān 173
 biànjiào jīngtóu 270
 biànsù 207
 biànsùgǎn 201, 207
 biànsùxiāng 202, 204
 biānxiàn 220, 221, 225, 226, 229, 230
 biānxiéshì CD bōfàngjī 268
 biānxiéshì shèxiàngjī 260, 269
 biànyāqǐ 60
 biānzhi 277
 biānzhiyán 288
 biānzhizhèn 277
 biānzhuāng 33, 34
 biāocéngtǔ 85
 biāohújiàng 82
 biāohúshuā 82
 biāohútái 82
 biāoqiān 172, 173
 biāoqiāng 234
 biāoshí 31
 biāoxiōngdì 22
 biāoxūn gǎnshù 233
 biāozhūnjiān 100
 bídǎi 163
 biǎdēng 62
 bídòu 19
 bǐji 242
 bǐji 175, 191

bǐjià 238
 bǐjiān 163
 bǐjiběn 163, 172
 bǐjiběn diànnǎo 175, 176
 bǐjīnyīngzhuāng 264
 bǐkōng 14
 bǐlìshì 316
 bilù 63
 bilù 315
 bilútái 63
 bǐng 36, 187
 bǐng 120, 151, 272, 287
 bǐngbào 286
 bǐngchá 149
 bǐngdú 44
 bǐngfáng 48
 bǐnggān 113, 141
 bǐnghé 284
 bǐngjǐlǐng 137, 149
 bǐngkāfēi 148
 bǐngkuài 151
 bǐngliè zhēngqiú 221
 bǐnglǐkē 49
 bǐngqiú 224
 bǐngqiú chǎng 224
 bǐngqiú qiúyuán 224
 bǐngshàng liúshí 247
 bǐngtóng 150
 bǐngǔ 17
 bǐngxī yánliào 274
 bǐngxiāng 67
 bǐngxié 224, 247
 bǐngzhù 287
 bǐpiāo 238
 bǐqǐ 124
 bǐqiú 231
 bǐsǎbǐng 154, 155
 bǐsǎbǐngdiàn 154
 bǐsǎi 229, 230
 bǐtóng 172
 bǐxié 44
 biyè 26
 biyèdiǎnlǐ 169
 biyèshēng 169
 biyóu 24
 biyún 21
 biyúntào 21
 biyúnyào 21
 bizhǐ 82
 bizhǐ niánhéjī 82
 bízǐ 14
 bó 257, 289
 bōcài 123
 bōcháng 179
 bōciwǎn 31
 bōdúōlǐgè 314
 bōěrtǔpútáojiù 145
 bōfāng 178, 269
 bōhào 99
 bōhe 133
 bōhechá 149
 bōhēi 316
 bōhetáng 113

- bóji 77
bójīcāo 250
bōlán 316
bōlàng 241
bōlànggǔ 74
bōlí 69
bōlí qimín 65
bōlibàng 167
bōlibēi 150, 152
bōlipíng 166
bōliwéiyà 315
bóliǎzi 314
bōluó 128
bōluódi hǎi 313
bōluózhi 149
bóshixuèwéi 169
bōshìniyà hé héisàigēwéinà 316
bówùguǎn 261
bōzhōng 90, 183
bùchíyú... 320
búdǎn 318
bùdīngmǐ 130
bùhán fúwùfèi 152
bùhánzhifāngde 137
bùjīnà fāsuo 317
bùjīng 178, 254
bùlǐ gānlǎo 142
bùliào 276
bùlóngdǐ 317
bùpǐ 277
bǔrú 53
bǔrú dòngwù 290
bǔrú xiōngzhào 53
bùtāipiàn 207
bùxíng rénsì 47
bùxíngqū 299
bùxíngxuē 37
bùxiàngāng 79
bùyú 20
bùzhāngwǔ 69
bùzhuō 245
- C
cā 77
cǎchuáng 68
càidān 148, 153, 154
càidānlán 177
càidì 182
càidòu 131
cǎifāngjìzhè 179
cáifēng 191
cáifengdiàn 115
càigēng 122
cǎihóng 287
cǎihuā 124
càijyuàn 155
cáiliào 79
cáipàn 225, 226, 227, 229, 230
cáipiào 112
càipǔ 85
cǎisèlàbì 274
cǎisèqiānbǐ 163
cǎishuǐ 239
càiyáo 153
cǎizhāi 91
càiziyóu 135
cānchá 65, 153
cānchē 209
- cānchǐ 65
cāndào 65
cándòu 122, 131
cāngkǔ 216
cāngmén 210, 281
cāngshǔ 290
cāngsuān 152
cāngyíng 295
cānhòutiāndiǎn 153
cānjiā 174
cānjīn 65, 152
cānjīn tàohuán 65
cānjīnzhǐ 154
cānjīnrén tíngchēchù 195
cānjù 64, 65
cānjù bǎifāng 65, 152
cānjù lishìjiā 67
cānjùdiàn 64
cāntíng 64, 101
cánzhā chūlǐqì 61
cānzhuō 64
cǎo 87
cǎochǎng 285
cǎodài 88
cǎodi 90
cǎoméi 127
cǎoméi nǎixi 149
cǎomǐ 130
cǎopáo 78
cǎopíng 85, 262
cǎotǔ 275
cǎoyào 108
cǎoyàochá 149
cǎoyuán 285
cǎozòng shǒubíng 269
cǎozuò zhuāngzhì 201, 204
cǎozuótái 66
cǎshāng 46
cǎshì 77
cǎshǒujīn 73
cāsù 67
CD bōfāngjī 268
cèliáng 310
céngyābān 79
cètí 237
cèxián 240
chá 144, 149, 156, 184
chá 88
chábāo 144
chábēi 65
chāchē 186, 216
cháchì 65
chàdiǎn 233
cháhú 65
chāhuā 111
chāikāi 277
cháyóu 199
cháyóujūchē 208
chājī 62
chājī 91
chākǎkǒu 97
chǎn 88
chǎnchú 294
chǎndiào 82
chǎng 32, 165
chǎng qūgūnqǔ 249
chǎngbǐng sàozhōu 77
chǎngbǐng shēn píngdīguō 69
- chǎngbǐng xiūlǐjiàn 88
chǎngbǐngsháo 68
chǎngbō 179
chǎngcǎoqū 232
chǎngdì 257
chǎngdù 310
chǎngfāngxíng 164
chǎnghào 257
chǎngjībǎn 179
chǎngjīnglù 291
chǎnglǐ 130
chǎnglù (zhìwù) 86
chǎngmáorón gwǎnjù 75
chǎngmáoróng wǎnjùxióng 75
chǎngpéng 260
chǎngpéngchē 199
chǎngqiāo huáxuē 247
chǎngtiào nǎiyóu jiānxīn diǎnxīn 140
chǎngtóng xiàngjiāoxuē 31
chǎngtóngwǎ 35
chǎngtǔ lúxíng 243
chǎngtúqìchē 196
chǎngyá 291
chǎngyí 250, 262
chǎnkē 49
chǎnkē bǐngfáng 48
chǎnkē yǐshēng 52
chǎnqián 53
chǎnqió 223
chǎnyīnqín 257
chǎnzi 265
cháo 286
chào 67
chāocǎi 158
chāochē 195
chāochū 320
chǎoguō 69
chāoji shìchǎng 106
chāojiàn 157
chǎonào 321
chāoshēngbō (jiǎnchá) 52
cháoshì 321
chāowǎng 244
cháoxiǎn 318
cháoxiǎnjì 124
chāoyīnsù fēiji 211
chǎozhǐ 159
chǎozhōng xínglǐ 212
chāpiàn 60
chātào 91
chātóu 60
cháyè 144
chāzuò 60
chē 272
chēbǎ 207
chēchuāng 209
chēdēng 207
chēdēng kāiguān 201
chēdǐng 203
chēdǐng xínglǐjià 198
chēfēi 197, 209
chēhuò 203
chējià 206
chēkǒu 58
chēkuāng 207
chēlián 206
chēlún 198, 207
- chēmén 196, 198
chēmén bǎshou 200
chéncǐ 180
chéng 165
chéng 69, 98, 118
chéng zhòngliàng 310
chéngbào 300
chénggǎntiào 234
chéngjī lièchē 209
chéngkè 216
chéngniánrén 23
chéngpán 310
chéngqiāo huáxíng 247
chéngshúde 129
chéngwèi 23
chéngxù 176
chéngzhèn 298
chéngzhuānpibǎn 186
chéngzi 121
chéngjiàn 288
chènli 32
chènqún 35
chènshān 32
chényí 32
chènzhǐ 83
chēpái 198
chēpiào 209
chēshēn 202
chēsùbiào 201, 204
chēsuo 207
chēxiānggējiàn 209
chēxiào 79
chēzhá 207
chēzhāndǎng 209
chēzuò 206
chí 305, 320
chī 64
chībǎng 119, 293
chícún 165
chídào 283
chídào jīnèiyà 317
chídòu 131
chīgǔ 17
chíguān 50
chílún 206
chíqiú chùdìdēfēn 221
chíshuǐ 238
chíshuǐxiàn 214
chítáng 85
chítiekuàng 289
chizi 163
chōngdiànshì diànzhuàn 78
chōnglǎng 241
chōnglǎng yùndòngyuán 241
chōnglǎngbǎn 241
chōngqì chuāngdiàn 267
chōngqì xiūdài 45
chōngqìshì xiāngpítǐng 215
chōngwù siliào 107
chōngwùshāngdiàn 115
chōngxī 38, 271
chōngxīn jiārè 154
chǒu 321
chǒujīn 239
chóumǎ 272
chōushuǐ mǎtǒng 61, 72
chōuti 66, 70, 172
chòuyǎngcéng 286
- chóuyóuyānjī 66
chú 165
chuāizi 81
chuān 214
chuānchǎng 217
chuāndòng zhuāngzhì 202
chuāng 70
chuāngdān 71, 74
chuāngdiàn 70, 74
chuānghù 58, 186, 197, 210
chuāngjiàobǎn 71
chuāngkètīe 47
chuāngkǒu 96, 98
chuānglián 63
chuāngmǎn 63
chuāngshāng 46
chuāngshāng yòngpǐn 71
chuāngtóubǎn 70
chuāngtóudēng 70
chuāngtóuguī 70
chuāngwéi 71
chuāngzhào 70
chuānpào 180
chuānqiú 220, 221, 223, 226
chuānrǎn 44
chuānròuqiān 68
chuānshàng chūfáng 214
chuānshǒu 214
chuānsòngdài 106
chuāntǐ 214, 240
chuántóu 240
chuánwéi 240
chuánwù 214, 216
chuānxún 180
chuānyuè 320
chuānzǎng 214
chuānzhen 98, 172
chuānzhen 277
chuānzhenjī 172
chuānzǐ 186
chúcǎoji 91, 183
chúchén 71
chúchòuji 73, 108
chúdào 68
chúdidēfēn 220
chúfā 213
chúfā tiàoshuǐ 239
chúfáng 66, 152
chúfáng 45
chúfáng diànjī 66
chúfáng yòngpǐn 105
chúfātái 238
chúguī 66
chuidiào zhōnglèi 245
chuífēngjī 38
chuǐgǎn 38
chuíxi 141
chuǐzhǐ 165
chuǐzhǐwéiyì 210
chuizi 80
chújiào 295
chújiè 226
chújú 110, 297
chúju 68
chúju 225, 228
chūkǒu 194
chūlǐgān jīngde 121
chūlǐqì 176

- chún 14
 chúnayuan 96
 chúncai 40
 chúnniú 136
 chúnshuà 40
 chūntiān 307
 chúnxiànbī 40
 chūqikǒu 61
 chūquán 237
 chūrúgǎng tóngdào 216
 chūshā 229
 chūshēng 26, 52
 chūshēng zhèngmíng 26
 chūshēngqián 52
 chūshēngshí tizhōng 53
 chūshī 190
 chūshīmào 190
 chūtou 88
 chūwǎng 230
 chūwūguī 62
 chūxù 96
 chūxù zhànghù 96
 chūyí 165
 chūyuàn 48
 chūzūchē sījī 190
 chūzūchēzhàn 213
 cīkādìnhuà 99
 cīqī 105
 cīshāng 46
 cītīē 167
 cīwěi 290
 cīxiù 277
 cōng 125
 cōng...lái 320
 cōngbù 320
 cōngtóu 125
 CT sāomiáo 48
 cù 135, 142
 cūféng 277
 cuī 127
 cuīmíán liáofǎ 55
 cùlì 127
 cūlìxiàomǎifēn 130
 cúnchūqī 176
 cūnī wàitào 31
 cūnjījiàkè 33
 cúnkuāndān 96
 cúnǔ 96
 cúnzhuāng 299
 cuōdāo 81
 cuòwù 321
 cùxiāo hǎibào 106
 cùzì 159
 cùzide 143
- D**
 dà 321
 dàán 163
 dàbīmùyùpián 120
 dàcháng 18
 dàchuí 187
 dàchūxué 46
 dǎdànqī 68
 dàdòu 131
 dàduìxià 121
 dàhān 71
 dàhào 257
 dàhāqian 25
- dàhuìhuǎn 247
 dàhuǒjī 112
 dài 311
 dài zhǐjiàde bǐjǐbǎn 173
 dàibīngshuǐhù 65
 dàibù 94
 dàibǔlǐng 180
 dàichānde 52
 dài huáng 127
 dài kuān 96
 dài qiú 222
 dàishù 291
 dài jiào táng 300
 dài jī yuè qī 257
 dài kōng qī 173
 dà liáng 186
 dài liào 133
 dài lǐ shí 288
 dài lù 282, 315
 dài lù jī 99
 dài mài 130, 184
 dài mēn 182
 dài mó jī 78
 dàn 137
 dàn bái 137
 dàn bái shí 288
 dàn bái tiān bīng 140
 dàn bǎn huà xué 247
 dàn běi 65, 137
 dàn dǎ 230
 dàn fēn 151
 dàn g 237
 dàn gǎng 235
 dàn gāo 140
 dàn gāo biāo huà dài 69
 dàn gāo kǎo mǔ 69
 dàn gāo zhī zuò 69
 dàn gǎng bǎi qīng xī jī róng qī 202
 dàn gǎng yuǎn bǎn 63
 dàn gǎn bǎn 205
 dàn guān liè chē 208
 dàn háng dào 298
 dàn huáng 137, 157
 dàn huáng guān 257
 dàn huáng jiàng 135
 dàn jià 94
 dàn jīng tóu fǎng guāng zhào xiàng jī 270
 dàn kē 137
 dàn mài 316
 dàn nǎi gāo 140
 dàn nǎi sù 158
 dàn piàn sān míng zhì 155
 dàn rén bīng fāng 48
 dàn rén láo fāng 94
 dàn rén chuāng 71
 dàn rén jiàn 100
 dàn rén láo fāng 181
 dàn shuǐ chuí diào 245
 dàn xiāng shuǐ 41
 dàn xíng 194
 dào...lǐ 320
 dào...qù 320
 dào cǎo rén 184
 dào chē 195
 dào chéng hù zhàng 159
 dào dài 269
 dào dàn 211
- dàogōu 244
 dàoguǎn 53
 dào lù 194
 dào lù jiāo chā chū de huán xīng lù 195
 dào lù shí gōng 187, 195
 dào ni qī 68
 dào piàn 66
 dào lù shí gōng 187, 195
 dào ni qī 68
 dào yān 254
 dào yǒu 260
 dào yù 282
 dǎ pò jī lù 234
 dà qī céng 282, 286
 dà qī xiàn 233
 dǎ shuǐ 239
 dà suàn 125, 132
 dà tǐng 100, 104, 255
 dà tǐ qín 256
 dà tóu zhēn 276
 dà tū 12, 119
 dà xī yang 312
 dà xíng gāo jī jiào chē 199
 dà xíng xīng 291
 dà xué 299
 dà xué shēng 169
 dà yáng 282
 dà yáng zhōu 319
 dà yīn 172
 dà yīn jī 172, 176
 dà zhī 15
 dé fēn 228, 273
 dé fēn qū 221
 dé guó 316
 déng 62
 déng jī bù 100
 déng jī mēn hāo 213
 déng jī pǎi 213
 déng jī tóng dào 212
 déng jī 105
 déng long guǒ 128
 déng lù 177
 déng pào 60
 déng pào jiē kǒu 60
 déng shì 165
 déng sī 60
 déng tà 207
 déng tǎ 217
 déng tuī 250
 déng xīn cǎo 86
 déng yú 165
 déng yuè cāng 281
 dī 164
 dī 321
 dī'èr 309
 dī'èr shí 309
 diǎn 273
 diàn 60
 diàn báo 98
 diàn báo 60
 diàn cǎi 153
 diàn chāng jī 268
 diàn chí 167, 202, 260
 diàn chí hé 78
 diàn dòng tī xù dāo 73
 diàn dòng 79
 diàn gōng 188
 diàn huà 99, 172
- diàn huà háo má chā xùntái 99
 diàn huà tǐng 99
 diàn huò 200, 266
 diàn huò dǐng shí 203
 diǎn jī 46
 diǎn jiān 35
 diǎn jī tā 258
 diǎn lǎn 79
 diǎn lì 60
 diǎn lí céng 286
 diǎn lǐ chē 208
 diǎn nēi yòng cān 154
 diǎn nuǎn qī 60
 diǎn qīng sè 274
 diǎn qī shí 288
 diǎn qiú 227
 diǎn quān 61, 80
 diǎn rǎn 71
 diǎn shì lián xù jī 178
 diǎn shì yǎn bō shì 178
 diǎn shuǐ hù 66
 diǎn tí 59, 100, 104
 diǎn xiàn 60
 diǎn xiàn 44
 diǎn yá 60
 diǎn yǐng fǎng yǐng tǐng 255
 diǎn yǐng bù jǐng 179
 diǎn yǐng yuán 255, 299
 diǎn yuán xiàn 176
 diǎn yuán xiāng yán cháng xiàn 78
 diǎn zī 54, 235
 diǎn zī chān pǐn 105
 diǎn zī qín 258
 diǎn zī yóu jiàn 177
 diǎn zī yóu jiàn dì zhǐ 177
 diǎn zī yóu jiàn zhàng hù 177
 diǎn zuàn 78
 diào chá 94
 diào chuāng 266
 diào gāo qí 231
 diào gōu 187
 diào huán 235
 diào jū 245
 diào jū xiāng 244
 diào kē 79, 275
 diào lán 84, 95
 diào róng gōu 118
 diào shòu yīn jī 269
 diào sù jiā 191
 diào wǎ dài 35
 diào yù 244
 diào yù 120
 diào yù xū kè zhèng 245
 diào yù zhē 244
 dì bā 309
 dì bǎn 62, 71
 dì bā shí 309
 dì bèi zhī wù 87
 dì biān yīng yuán de 41
 dī céng 141
 dī dá 213
 dī dài 283
 dī dīng 266
 dī yǒng 239
 dī guān 109, 167
 dī jī 109
 dī jiào 183
- dì jū 309
 dì jū shí 309
 dì lǐ 162
 dì liù 309
 dì lù shí 309
 dì lù 72
 dì mǎn 282
 dì mào 284
 dìng 79, 90
 dìng céng 141
 dìng diǎn 164
 dìng jī piào 212
 dìng grén 227
 dìng shū dīng 173
 dìng shū jī 173
 dìng xiāng 133
 dìng xíng 38
 dìng xíng shuǐ 38
 dìng yīng 257
 dìng zhēn 276
 dìng zī 80
 dìng zī gāo 187
 dìng zī tóu 80
 dī pán 203
 dī piān 271
 dī qī 309
 dī qī 83
 diào 282
 dī qī shí 309
 dī qiú 280, 282
 dī qū 315
 dī sān 309
 dī sān shí 309
 dī shí 309
 dī shì bā 309
 dī shì èr 309
 dī shì jū 309
 dī shì liù 309
 dī shì qī 309
 dī shì sān 309
 dī shì sì 309
 dī shì wù 309
 dī shì yī 309
 dī sī 309
 dī sī shí 309
 dī sòng 98
 dī tǎn 63, 71
 dī tiē 208
 dī tiē xiàn lù tū 209
 dī tū 195, 261
 dī tū 91
 dī wú 309
 dī wú shí 309
 dī xiān 226, 230
 dī xiā shí 58
 dī yá dài kuān 96
 dī yī 309, 320
 dī yī bāi 309
 dī yīn dàn huáng guān 257
 dī yīn jī tā 258
 dī yīn jī tā shòu 258
 dī yīn pū hào 256
 dī yīn tǐ qín 256
 dī yù 315
 dī yù biāo zhǔn gān shù 233
 dī zhèn 283
 dī zhī 98
 dī zhōng hǎi 313

- dōng 312
dōngdiwēn 319
dōnghuàpiān 178, 255
dōngjī liǎngxiàng 247
dōngjī yúndòng 247
dònglì huáxiàngjī 211
dòngmài 19
dōngnánguā 125
dōngqingshù 296
dōngsuānnái 137
dōngtiān 31, 307
dōngwù 290, 292, 294
dōngwúxué 169
dōngwúyuán 262
dōngzuo 227, 229, 233, 237
dòubàncài 123
dòujiá 122
dòulèi 131
dòuyá 122
dú 162
duǎn 32
duǎnbīng sàozhou 77
duǎnbō 179
duǎnchènku 33
duǎndài 27, 111, 141
duǎndí 257
duǎnfā 39
duǎnkǒu 176
duǎnkù 30, 33
duǎnliàn 250
duǎnpāibìqiú 231
duǎnpào xuānshǒu 234
duǎnshù 296
duǎntú xiàochē 232
duǎnwēn'è 293
duǎnxiàn 99
dǔchǎng 261
dùchuán 215, 216
dùchuán mǎtóu 216
dùdài 242
dúdòngzhùzhái 58
duifāng fúfèi diànhuà 99
duiféi 88
duijiāngqī 59
duijiāoxiàn 164
duiliúcéng 286
duiliúshì diànnuǎnqì 60
duishǒu 236
duixiàn 97
duiyuánxí 229
dùliàng 165
dùliánghéng 310
dùlìshì 58
dùlún shòutuíchē 88
dúmùzhōu 214, 241
dūn 310
dùncài 158
dūnqì 250
duò 241
duòbǐng 240
duòfēng 286
duògē 317
duòmínjījià 314
duòmínikè 314
duòmínuò gǔpái 273
duòniánshēng (zhìwù) 86
duòxiāngguó 132
duóyún 286
- duōzhī 127
duōzhōng wéishēngsù zhìjī 109
dùqì 12
dùsōngzìjū 145
dùzhù 273
DVD bōfāngjī 268
DVD guāngpán 268
- E**
é 119, 293, 295
è 64
édàn 137
èguāduōèr 315
èi 273
éjī 16
èlǐ 128
èlìtēiyá 317
éluósīliánbāng 318
ènkòu 30
èr 308
ěr 244
ěrbǎi 308
ěrbīhòukè 49
èrcéng 104
ěrduò 14
ěrhuán 36
ěrjī 268
èrkē 49
èrlóu tīngzuò 254
èrmiánshēng (zhìwù) 86
èrshí 308
èrshí fēngzhōng 304
értóng 23, 31
értóng ānquánsuǒ 75
értóng bàonuǎnkù 31
értóng bìngfāng 48
értóng fāngxuēzhuāng 30
értóng shuǐyī 31
értóng tàocǎn 153
értóng xīshuǐchí 263
értóng yòngpǐnbù 104
értóngzuyǐ 198, 207
èrtóujī 16
èrtóujī xùnlìan 250
èrxí 22
èryuè 306
érzǐ 22
èxin 44
èyú 293
èyújiá 167
- F**
fáchūchǎngwài 223
fādài 39
fādiànqì 60, 207
fādiànqìu 223
fādòngjī 202
fāgēn 39
fāgū 38
fāguān 180
fāguó 316
fājī 39
fājìanlǎn 172
fājīao 38
fājīao 139
fālù 169, 180
fālùshìwùbù 175
fālùzìxún 180
- fāmǎ 166
fān 241
fānbǎn 241
fānbǎn yúndòng 241
fānbǎn yúndòngyuán 241
fāncài 64
fānchuán 215, 240
fānchuán yúndòng 240
fāndìgāng 316
fāndòukǎchē 187
fāngbiàn shípín 107
fāngbōdì 217
fāngchénbù 83
fāngdà 172, 271
fāngdào jǐngbào 58
fāngdìchǎnshāng 115, 189
fāngdōng 58
fāngdōngyè 199
fāngfēng shéng 266
fāngfēngjiákè 33
fāngfēngjīng 265
fāngfújī 83
fānggé 272
fānghùmiànqū 225, 228, 236
fānghùpán 88
fāngjiān 58, 100
fāngjiàn dǎngbǎn 66
fāngjiān hàomǎ 100
fāngjiān sòngcǎn fúwù 101
fāngjiān yàoshì 100
fāngjiēshì 289
fāngkè 58
fāngkuài 273
fāngshàishuāng 108
fāngshìyè 108, 265
fāngshìyóu 265
fāngshèkè 49
fāngshēng 245
fāngshù 220
fāngshòuduiyuán 223
fāngshòuqū 224
fāngshuikǒu 244
fāngsōng 55
fāngsuǎng jiāndài 205
fāngsuǎngbǎn 204
fāngsuǎngjīng 207
fānguí 223, 226
fāngwǔ 58
fāngxiāng liáofǎ 55
fāngxiàngduò 210
fāngxiàngpán 201
fāngyǎngde 118
fāngyǔzhào 266
fāngzhī 277
fāngzhuànguǎnhúlán 195
fāngzú 58
fānhéng 240
fānjiāosuǒ 241
fānjīndǒu 235
fānlǎn 215, 240
fānlǐng 32
fānmùguā 128
fānqié 125, 157
fānqiéjiāng 135, 154
fānqiézhi 144, 149
fānshèjīng 167
fānshìliú 128
fānshǒu 231
- fánzào 25
fánzujīlù 181
fāpái 273
fāqī 139
fāqià 38
fāqiú 231
fāqiúdèfēn 230
fāqiúfāng zhànxiān 230
fāqiúqū 223
fāqiúqū 232
fāqiúshìwù 230
fāqiúxiàn 226
fāqiúxiàn 230
fāsè 39
fāshào 44
fāshāo fēnchà 39
fāshè 281
fāshèjià 281
fāshì huayuán 84, 262
fāshì jièmojiàng 135
fāshì pántóu 39
fāshìtúsi 157
fāshù 38
fāshù guiyànà 315
fāshuà 38
fāsòng 177
fātīng 180
fāxing 39
fèi 18
fèibiāo 273
féichángjī 16
féigú 17
fèiji 319
fèiji 210
fèilào 91
féiliàoduī 85
féilǔbin 319
féiròu 119
féishuǐzhǔ 67
fèitānsuān 144
féixíng 211
féixíngyuán 190, 211
féiyuēguò 128
féizào 73
féizàohé 73
féizàojiù 178
féizhīlǒu 172
féizhōu 317
féizhōujú 110
fēnbǐ 162
fēnbǐng 40
fēnbù 175
fēncānchí 68
fēndào 234
fēndí 40
féng 277
féng 241, 286
féngdǎng 198, 205
féngyè 173
fénggān 159
fénggānde 143
fénghé 52
fénghéxiàn 34
féngmào 31
féngniào 292
féngōngsī 175
féngren yòngpǐn 105
féngrenjī 276
- fēngshàn 60, 202
fēngshànpidài 203
fēngshù 296
fēngshuǐ 55
fēngtángjiāng 134
fēngtángjīnpào 159
fēngzuàn 187
fēnhé 40
fēnhóngsè 274
fēnlán 316
fēnlèijià 100
fēnlèixiāng 61
fēnmiàn 52, 53
fēnmù 165
fēnnù 25
fēnpǔ 40
fēnshù 165, 220
fēnshuà 82
fēnzhèn 304
fēnzhōng 304
fēnzǐ 165
fù 12, 165
fúbǎn 238
fúbiāo 217, 244
fúdiào jiàoshì 54
fúgǔgōu 12
fúhuójié 27
fúji 167
fúji 16
fújiàn 177
fújiāshìyuán 211
fúkè 49
fúkè yishēng 52
fúkèlǎn qúndào 315
fukuān 96
fùmǔ 23
fùnǚ bǎojiàn 108
fúpénzǐ 127
fúpénzǐjiàng 134
fúpimìanbào 139
fúqiáng 301
fúqīn 22
fúqiú 61
fūsè 41
fúsè jiàoshēn 41
fúshǐ 73, 288
fúshì chēdào 195
fúshǒu 59, 196, 200, 210
fúshōuyí 63
fúshǔ jiànzhùwù 182
fúshuǐqíqiú 265
fúsùshù 47
fútèijiājiù 145
fútiáo 207
fúwòchéng 250
fúwú 94
fúwúchē 212
fúwúqì 176
fúwúshāng 177
fúxiào 305
fúxié 44, 109
fúyì 210
fúyìn 172
fúzhàng 153
fúzhōng yàodài 239
fúzhuāng 205
fúzuòyòng 109

- G
 gài 109
 gàizi 61, 66
 gǎi 158
 gǎilífēn 132
 gǎn 67
 gǎn 245
 gǎn'ēnjiē 27
 gāncǎo 184
 gāncǎotáng 113
 gānchūanwù 217
 gāngà 25
 gāngbǐ 163
 gāngbiyà 317
 gāngguó 317
 gāngguó mínzhǔ gònghéguó 317
 gāngjū 81
 gāngkǒu 214, 216, 217
 gangling hénggān 250
 gāngqín 256
 gāngsīqián 80
 gāngsīróng 81
 gāngsuǒ 129, 156
 gāngsuǒ 166
 gāngwù júzhǎng 217
 gānhuā 111
 gānjīng 321
 gānjing yīwù 76
 gānjú 126
 gānjúlèishuǐguó 126
 gǎnlǎn 151
 gǎnlǎnqíu 220
 gǎnlǎnqíu qiúyí 221
 gǎnlǎnyóu 134
 gǎnlào dàngāomú 69
 gǎnmào 44
 gǎnmiànzhàng 69
 gǎnxidiàn 115
 gǎnxing (pífū) 41
 gǎnzàng 18, 118
 gǎnzào 130, 286, 321
 gǎnzhè 184
 gāo 165, 321
 gāo'ěrfū qiúchǎng 232
 gāo'ěrfū qiúchē 233
 gāo'ěrfū qiúdài 233
 gāo'ěrfū qiúgān 233
 gāo'ěrfū qiúxié 233
 gāo'ěrfū qiúyuán 232
 gāo'ěrfūqiú 232, 233
 gāobāozhēn yīnxiǎng xitǒng 268
 gāodà 321
 gāodēngyuànxiào 168
 gāodēngzhuānkē xuéxiào 169
 gāodiàn 140
 gāodiàndiàn 114
 gāodīgàng 235
 gāodù 211
 gāogēnxié 37
 gāojià qiáoxià tóngdào 194
 gāojiǎoyí 75
 gāojīnmiànfēn 139
 gāomǎnào 289
 gāoshān huàxuē 247
 gāoshān sùjiàng 247
 gāoshān zhīwù 87
 gāosùgōnglù 194
 gāosùlièchē 208
 gāotái tiàoshuǐ 239
 gāowán 21
 gāoyángrou 118
 gāoyīn pūhào 256
 gāoyū biāozhǔn gānshù 233
 gāoyuán 284
 gāozhīfángnǎiyóu 137
 gēbān 67, 210
 gēcǎo 90
 gēcǎoji 90
 gēcǐ 259
 gédóuyùndòng 236
 gējia 66, 268
 gējū 255
 géli 121
 gélidài 194
 gélinglǎn 314
 gélinnàdà 314
 gélóu 58
 gélǔjīyà 318
 gélúnbiyà 315
 gélúzǐ 131
 gēmi 258
 gēn 124, 296
 gēngchà 321
 gēnghào 321
 gēnghuàn lǔntái 203
 gēngyīshi 104
 gēnjiàn 16
 gēqū 259
 gērécéng 61
 gēshāng 46
 gēshi wénjiànjiā 173
 gēshǒu 191
 gēsīdǎlǐjiā 314
 gētèshi 301
 gēzi 292
 gōng 289, 301
 gōng 249
 gōngchǎng 299
 gōngchéngxué 169
 gōngdiàn xitǒng 60
 gōnggāolán 173
 gōnggōngqīchē 196
 gōnggōngqīchē sījī 190
 gōnggōngqīchē zǒngzhàn 197
 gōnggōngqīchēpiào 197
 gōnggōngqīchēzhàn 197, 299
 gōnggū 17
 gōngguó 315
 gōngjī 94, 185
 gōngjiàn bù yātū 250
 gōngjiàoxiànlùhào 196
 gōngjiù 187
 gōngjùdào 80
 gōngjùjià 78
 gōngjùlǎn 177
 gōngjùxiāng 80
 gōngjùyàodài 186
 gōnglǐ 310
 gōnglǐ fàngdàqì 268
 gōnglǐchē 206
 gōngmén 85
 gōngnèibiyúnqì 21
 gōngniú 185
 gōngqīchē hòuchēting 197
 gōngshuǐguǎn 61
 gōngsī 175
 gōngsù 180
 gōngsuǒ 52
 gōngwénbào 37
 gōngxing yuánding 300
 gōngyèqū 299
 gōngyidào 82
 gōngyīmèishù 274, 276
 gōngying sāncǎn 101
 gōngyù 59
 gōngyuán 262
 gōngyùlǒu 59, 298
 gōngzhuāngkù 30, 83
 gōngzīdān 175
 gōngzuò 175
 gōngzuòjiàn 78
 gōngzuòrì 306
 gōngzuòtái 78
 gōngzuòwūcān 175
 gōu 290
 gōulǎ xuéqiāo 247
 gōuwú 104
 gōuwù zhīnán 104
 gōuwùchē 106
 gōuwùdài 106
 gōuwùlǎn 106
 gōuwùzhōngxīn 104
 gōuyàn 244
 gōuzhēn 277
 gōuzhī 277
 gǔ 17, 258
 guāchǎn 68
 guāchū 77
 guādao 82, 167, 275
 guāhào yóujiàn 98
 guān 145, 292, 311
 guān 321
 guāndào zhuāngzhì 61
 guāndiànshì 269
 guàngài 183
 guāngbō 179
 guāngbōdiàntái 179
 guāngchǎng 299
 guānggào 269
 guānggào yánliào 274
 guānggòuping 134, 311
 guāngguān tiáojiéhuàn 270
 guāngguāng 260
 guāngguāngbāshì 260
 guānjié 17
 guànlán 227
 guānmén 260
 guānmù xiūjiàn 87
 guānniányóu 137
 guānniào 263
 guānshāng (zhīwù) 87
 guàntóuhé 311
 guānyú 320
 guānzhòng 233, 254
 guànzhuāng shípín 107
 guànzhuāng shuǐguó 135
 guànzhuāng yīnliào 154
 guāpí 127
 guāràng 127
 guàtújià 174
 guāzǐ 127
 gūbā 314
 gūcāng 182
 gūdiǎn yīnyuè 255, 259
 gūdingluómù 203
 gūdòngdiàn 114
 gūfēn 97
 gūfēn 88
 gūfu 22
 gūgé 17
 gūgù 17
 guì 321
 guī 293
 guǐdào 209, 280
 guīkē 293
 guīpí 133
 guítai 96, 98, 100, 142
 guīyànà 315
 guīyú 120
 gūji 261
 gūkè 38, 104, 106
 gūlèishípín 130, 156
 gūli 130
 gūmā 22
 gūmǐ 130
 gūndòngtiáo 177
 gūntǒngshì hōnggānjī 76
 gūnzhou liúbīng 263
 gūnzimianbào 138
 guòdao 106, 254
 guōgài 69
 guōjī hángxian 212
 guōjiā 315
 guōjiāgōngyuán 261
 guōjiàng 156
 guōjiàngbing 142
 guōjitiàoqì 272
 guōjixiàngqì 272
 guōlán 126
 guōliáng 186
 guōling 232
 guōlù 61
 guōlùshì kāfēi 148
 guōmín 44
 guōnèi hángxian 212
 guōrén 122, 129
 guōrén qiàokèlì cuǐbing 141
 guōròu 124, 127, 129
 guōshānchē 262
 guōwèisuānnǎi 157
 guōwèixiàngpitāng 113
 guōyuán 183
 guōzhī 149, 156
 guōzhī bīnggāo 141
 gūpén 17
 gūpiào jiàgè 97
 gūpiào jīngjirén 97
 gūquán 97
 gūshìpiàn 269
 gūshǒu 258
 gūtǐfēngmǐ 134
 gūtou 119, 121
 gūwèn 55
 gūwù 130
 gūxī 97
 gūyuán 24
 gūzhāng 203
 gūzhānghècǎi 255
 gūzhé 46
 gūzhìhuán 89
 gūzhǔ 24

- H
 hái 264, 282
 hái'an 285
 hái'an jīngwèidui 187
 hái'ou 292
 hàibào 255, 290
 hàibīn bùdào 265
 hàibīn yóuyōngdài 264
 háidi 314
 hái'guān 212, 216
 hái'guī 293
 hái'lánbāoshì 288
 hái'làng 264
 hái'lù 120
 hǎimǎ 294
 hǎimián 73, 74, 83
 hǎimiáncéng 126
 hǎishǐ 290
 hǎitān 264
 hǎitān xiǎowù 264
 hǎitān yǔjīn 265
 hǎitūn 290
 hǎiwángxīng 280
 hǎixiàn 121
 hǎixiàng 290
 hǎixīng 295
 hǎiyáng bǔlǎo 245
 háizi 23
 hán jiūjīng yīnliào 145
 hánbǎobào 154, 155
 hánbǎotàocǎn 154
 hángbǎnhào 212
 hángfēng 277
 hángkōng mùjiàn 215
 hángkōng yóujiàn 98
 hángtiān fēiji 281
 hángwù 318
 hángxíng 240
 hánjiē 79
 hánqiān 199
 hánxī 79, 81
 hánzhàn 44
 hào 321
 háogōu 300
 hàokàn 321
 hàokè 310
 háomí 310
 hàoqiú 228
 háoshēng 311
 hasàkēsītān 318
 hé 127
 hé 292
 hé'àn 284
 hé'ěrméng 20
 héchéngde 31
 hégū 17
 hégūxiàn 89
 hèiàn 321
 hèibǎn 162
 hèicùlì 127
 hèidài 237
 hèidòng 280
 hèifúshuāng 41
 hèigǎnlǎn 143
 hèigé 272
 hèihǎi 313
 hèikāfēi 148
 hèimàimiànfēn 138

- hēiméi 127
 hēimiànbào 138, 139, 149
 hēiqiāokèlì 113
 hēisāigēwéinà 316
 hēisè 39, 274, 321
 hēishān 316
 hēitáo 273
 hēixiànxuě 120
 hēiyāndòu 131
 hēiyàoyán 288
 hēiyù 288
 hēkā 27
 hékǒu 285
 hélán 316
 héliú 284
 hémǎ 291
 hēnduó 320
 hénggān 235
 hénggāng 250
 hénggémó 19
 héngliáng 207
 héngzuò'ān 242
 hēnshāo 320
 héqidào 236
 hèsè 274
 hèsèxiāobiāndòu 131
 hēshì cidàiluyīnjī 269
 hēshì lùyīndāi 269
 hēshì wénjiānjiā 173
 hétāo 129
 hétaoyóu 134
 hóng(pútáojiǔ) 145
 hóngbāoshì 288
 hóngchá 149
 hóngcūlì 127
 hóngdòu 131
 hóngdūlāsī 314
 hóngghǎi 313
 hóngghèsè 39
 hóngghuācǎidòu 122
 hóngkǎo càyáopán 199
 hóngkǎo shípín 107
 hóngkǎode 129
 hóngmó 51
 hóngpái 223
 hóngqiújiǔjù 123
 hóngròu 118
 hóngsè 274
 hóngshǔ 125
 hóngshuǐ 287
 hóngxīn 273
 hóngyán 271
 hóngyù 294
 hóngyúndòu 131
 hóngzhāji 211
 hóngzhì 67, 138, 159
 hóngzōngsè 39
 hóngzūnyù 120
 hòu 272, 321
 hòudìxié 37
 hòujiābǎn 214
 hòujìdàtīng 213
 hòujié 19
 hòujīlòu 212
 hòujīng 13
 hòulún 197
 hòutiān 307
 hòutóu 19
 hòutūròu 119
 hòuzhēnshì 45
 hóuzi 291
 hòuzuò 200, 204
 hú 164, 285
 hǔ 291
 huà 62, 162, 274
 huā 110, 297
 huā'è 297
 huábǎn 249, 263
 huábàn 297
 huábàn yúndòng 249
 huābào 111
 huàbì 274
 huābiān 35
 huàbù 274
 huáchuán 241
 huáchuánji 250
 huádián 110
 huáfēn 276
 huáfúbǐng 157
 huāgāngyán 288
 huāgépíng 84
 huāguān 111
 huáhánbǐng 249
 huāhuán 111
 huài 321
 huàiyùn 20, 52
 huàiyúnde 52
 huàiyúnsāngēyuè 52
 huàjī 99
 huàjià 274
 huàjiā 191, 274
 huàjiān 249
 huàjiāngchuán 214
 huàkuàng 62
 huàlěi 229
 huālěi 297
 huàn píndào 269
 huànchéng 209
 huàndēngjī 163, 174
 huàngfēng 295
 huàngǎidíe 120
 huànguā 125
 huànghūn 305
 huàngpái 223
 huàngsè 274
 huàngshuixiān 111
 huàngyóu 137, 156
 huàngyù 288
 huánjīng 280
 huànrén 223
 huànshūriqi 168
 huànxióng 290
 huànyidiàn 74
 huànzhè 45
 huāpén 89
 huāpíng 63, 111
 huāshāng 188
 huāshèng 129, 151
 huāshèngjiàng 135
 huāshèngyóu 135
 huāshiqìshù 243
 huàshù 296
 huāshù 35, 111
 huāshuǐ 239, 241
 huāshuǐqiāo 241
 huāshuǐzhè 241
 huātán 85, 90
 huátí 263
 huàtóng 179
 huáxiáng 248
 huáxiángjī 211, 248
 huáxiángsǎn 248
 huáxing 224
 huáxuě 246
 huàxuē 162
 huàxuē pódào 246
 huàxuēbǎn 246
 huàxuēfú 246
 huàxuējǐng 247
 huàxuěshān 31, 33
 huàxuēxuē 246
 huàxuězhàng 246
 huàxuězhè 246
 huāyàng 83
 huāyàng huábīng 247
 huāyàng yóuyóng 239
 huāyēcài 124
 huāyuan 84
 huāyuán zhuāngshì 84
 huāyuánfēnggē 84
 huāyuánzhìwù 86
 huàzhuāng 40
 huàzhuāngjīng 40
 huàzhuāngpǐn 107
 huàzhuāngshuā 40
 hùchǐ 237
 hùdié 295
 hùfāsù 38
 huì 293
 huìdà 163
 huìgān 232
 huìhé 230, 237
 huìhuà 261, 274
 huìjiāng 187
 huìlǚ 97
 huìpiào 98
 huìqiú 231
 huìsè 39, 274
 huìshòuzhàn 177
 huìsù 232
 huìwéi 280
 huìxiāng 122, 133
 huìxiāngzǐ 133
 huìxing 280
 huìyān 19
 huìyì 174
 huìyìjìlǚ 174
 huìyìshì 174
 huìzhāng 189
 hùjiān 224
 hùjiào ànniù 48
 hùjiāofēn 64, 152
 hùjiāoli 132
 hùkūi 236
 húlì 290
 hùlǐ 91
 hùliánwǎng 177
 hùlǔbà 132
 hùlúobo 124
 hùmǎjīng 81, 167
 hūnjúé 44
 hūnlǐ 26, 35
 hūnlǐ dāngāo 141
 hūnnǐngtǔkuài 187
 hūnyàn 26
 hūnyǐntái 179
 huòbì 97
 huòbì miànè 97
 huòcāng 215
 huòchá 112
 huòchē 208
 huòchéngyán 288
 huòchētóu 208
 huòchēzhàn 208
 huòchuán 215
 huòdòng 245, 263
 huòdòng wánjù 74
 huòdòngguàtú 174
 huòhuāsāi 203
 huòjī 119, 185, 293
 huòjià 106
 huòlièniào 292
 huòlǚ 67
 huómian 138
 huòpángjiàn 16
 huòqíncúkuǎn zhànghù 96
 huòqíng 95
 huòshān 283
 huòshāndào 283
 huòshānhuī 283
 huòshānkǒu 283
 huòtuī 119, 143, 156
 huòtuīpiàn 119
 huòwù 216
 huòxiàn 280
 huòxīng 60
 huòyúlóng 244
 huòzāi jīngbàoqi 95
 hùshì 45, 48, 52, 189
 hùtuī 225
 hùwàihuòdòng 262
 hùwàn 230
 hùwéi 74
 hùxī 205, 220, 227
 hùxī 47
 hùxìtiàoqié qì 239
 hùxìxitóng 19
 hùzhào 213
 hùzhào jiāncháchù 213
 jiàkèlè lǎngmǔjū 151
 jiàlāpàgēsī qúndào 315
 jiàlèbì hǎi 312
 jiālǐninggélè 316
 jiālún 311
 jiànbùbiào 154
 jiàn 176, 249
 jiàn 38, 165, 295
 jiān 13, 36, 67, 122
 jiàn 17
 jiānà 317
 jiānàdà 314
 jiāncái 277
 jiāncái kǎojiu 35
 jiāncǎoji 88
 jiāncǎoqi 88
 jiānchá 49, 50
 jiàndài 35, 249
 jiāndàn 157
 jiāndanbǐng 158
 jiàndào 236
 jiàndào 38, 47, 82, 188, 276
 jiāndīng 300
 jiāndīngshì 300
 jiàng 143, 155
 jiāng 241
 jiāng 125, 133
 jiāngguó 127, 296
 jiānghào 256
 jiānghuāngēn 132
 jiāngjiēren 174
 jiāngluòsǎn 248
 jiāngpái 235
 jiāngquán 112
 jiāngshéng 242
 jiāngshì 169
 jiāngshǒu 241
 jiāngsuǒ 129, 151
 jiāngsuǒ 69
 jiāngxuējīn 169
 jiānhuìyì 53
 jiānjiǔgū 17
 jiànkāng 44
 jiànkāngde 321
 jiànkāngzhōngxīn 168
 jiànlán 110
 jiànpán 172, 176
 jiānpàokou 209
 jiānpiaoyuán 209
 jiānpúzài 318
 jiànshēn 250
 jiànshēn qixiè 250
 jiànshēnchē 250
 jiànshēnfáng 101, 250
 jiànxiè pēnquán 285
 jiànxiūjīng 299
 jiànyù 120, 294
 jiānyù 181
 jiānyùchǎn 68
 jiànzhào 186
 jiànzhèngqì 205
 jiànzhì 159
 jiànzhù 186, 300
 jiànzhù cáilìào 187
 jiànzhù fēnggē 301
 jiànzhùgōngdì 186
 jiànzhùgōngrén 186, 188
 jiànzhùshì 190

- jiànzhùwù 299
 jiānzūqián 80
 jiào 12, 15, 164, 291
 jiāo 275
 jiāobàn 67, 138
 jiāobànbàng 150
 jiāobānqì 66
 jiāobànróngqì 66
 jiāobānwǎn 69
 jiāobèi 15
 jiāochā xunliànqì 250
 jiāodà 67
 jiāodàijià 173
 jiāodēng 206
 jiāodōng 67
 jiāoguàn 89
 jiāohán 25
 jiāohébān 79
 jiāohùgēn 13, 15
 jiāohuái 13, 15
 jiāohuichū 194
 jiāojuàn 271
 jiàokēshù 163
 jiāoliúdiàn 60
 jiāoliúfadiànqì 203
 jiāolóu 300
 jiāomó 51
 jiāomǔ 138
 jiāonáng 109
 jiāonàicè 15
 jiāopiàn 260, 271
 jiāopǔ 239
 jiāoqí 223
 jiāoqiāng 78
 jiāoqiú 223
 jiāoqū 299
 jiàoshì 162
 jiāoshǒujià 186
 jiāoshuǐ 90
 jiàotáng 299, 300
 jiāotáng 113, 139
 jiàotáng dànnǎi 141
 jiàotōng 194
 jiàotōng biāozhì 195
 jiàotōng jīngchá 195
 jiàotōng xīnhàodēng 194
 jiàotōng yúnshū 194
 jiàotōngdúsè 195
 jiāoxiāngyuè 256
 jiāoxīngwàikē 49
 jiāoyōu 26
 jiāozhàng 15
 jiāozhǐ 15
 jiāozhǐ 159
 jiāopéng 317
 jiáqián 78, 150, 166
 jiáqiánzuò 166
 jiáqiáochóng 295
 jiārè yuánjiàn 61
 jiàri 212
 jiàri zhínán 212
 jiàshàngpǐ 15
 jiàshǐ 195
 jiàshǐ 181
 jiàshǐ 223
 jiàshǐcāng 210
 jiàshǐshì 95, 208
 jiàshǐtái 214
 jiàshǐxí 196
 jiàshǐzuò 204
 jiàshuǐ wèishìjì 151
 jiàsùqì 200
 jiàtīng 22
 jiàtīng jiàochē 199
 jiàtīng rìyǒngpīn 107
 jiàtīngyúlè 268
 jiàxiān 140
 jiàxiānsù 140
 jiàyà 50
 jiàying 244
 jiàying chuidiào 245
 jiàyǒng diànqì 107
 jiàyǒng fāngzhīpīn 105
 jiàyǒng yàoxiāng 72
 jiàyóuchū 199
 jiàyóuzhàn 199
 jiàzhuàngxiàn 18
 jiàzigǔ 258
 jībǐjì 163
 jībīng 44
 jībùtí 317
 jīcāng 210
 jīchàng 212
 jīchí 243
 jīchí jiàozhèngqì 50
 jīdǎ 237
 jīdàn 137
 jīdào (duìshǒu) 237
 jīdì 282
 jīdòng xuèqiāo 247
 jiēbèishì jiàochē 199
 jiēbēng 287
 jiēcàizì 131
 jiēchū 168
 jiēchūguǐ 209
 jiēdài zǒngtái 100
 jiēdàiyuán 100, 190
 jiēdào 298
 jiēdi 60
 jiēdiàn zhuāngzhì 266
 jiēdòng 67
 jiégǔ 49
 jiéhùn 26
 jiéhùn lífú 35
 jiējǎo 298
 jiékè 316
 jieli 235
 jièlibàng 235
 jiémáo 14
 jiémáogāo 40
 jiémén 61
 jiémànshuǐ 41
 jièmo 155
 jiémù 254, 269
 jiémùbēi 269
 jiémùbiānpái 178
 jiémùzhūchírén 178
 jiépài 259
 jiēpǎodào 167
 jiéqing 27
 jiéqiú 220, 225, 227, 229
 jiéqíushǒu 229
 jiérì 27
 jiérìsītān 318
 jièrù 168
 jièshào 174
 jiēshǒu 177
 jiēshù 321
 jiēshūchū 168
 jiēshūzhèng 168
 jiētījiāoshì 169
 jiētīng diànhuà 99
 jièwàiqì 228
 jièxiànyuán 99
 jièzhì 36
 jièzhòng 45
 jīfēng 287
 jīfēnpái 225
 jīfù 23
 jīguāng 286
 jīguāng chángpán 269
 jīhè 165
 jījīàn 249
 jījǎohuái cháng 34
 jījīé 307
 jījū 47, 94
 jījū rényuán 94
 jījūxiāng 47
 jīkuài 155
 jīlàng tóudiào 245
 jīliàng 109
 jīliú 241, 284
 jīlù 234
 jīlùpiàn 178
 jīmù 23
 jīn 289
 jīn'è 96
 jīnbābùwéi 317
 jīnbīaosài 230
 jīng 12, 111, 290
 jīngbāmìniǎnfēn 138
 jīngchá 94, 189
 jīngchájù 94
 jīngcháng 320
 jīngchē 94
 jīngdēng 94
 jīngdì 94
 jīnggǔ 17
 jīngguān 94
 jīnggūn 94
 jīnghuī 94
 jīngjià 51
 jīngjìcāng 211
 jīngjìchāng 243
 jīngjìxué 169
 jīngkǒng 25
 jīnglí 24, 174
 jīngluán 44
 jīngmài 19
 jīngnáng 21
 jīngōng 220
 jīngōngqū 224
 jīngpiàn 51
 jīngshén liáofǎ 55
 jīngshēnkè 49
 jīngshēnpén 72
 jīngshìdēng 201
 jīngtóu 270
 jīngtougài 270
 jīngtuō 46
 jīngxián 283
 jīngxiānpīn 255
 jīngyà 25
 jīngyóu 55
 jīngzhuàngtǐ 51
 jīngzhuī 17
 jīngzì 63, 71
 jīngzì 20
 jīniànbēi 261
 jīniànpīn 260
 jīnjī chūkǒu 210
 jīnjī qíngkuàng 46
 jīnjī shāchēzhà 209
 jīnjú 126
 jīnpái 235
 jīnpào 130
 jīnqiāngyú 120
 jīnqǐkǒu 61
 jīnqǐdùfēn 223
 jīnróng 97
 jīnrúchǎnwù 217
 jīnsè 39
 jīnshēn nèiyī 35
 jīnshēnyī 250
 jīnshì 51
 jīnshù 79, 289
 jīnshù zuàntóu 80
 jīnshùxiàn 79
 jīnsīquē 292
 jīntiān 306
 jīnù 23
 jīnwǎng duànqì 230
 jīnxíng 280
 jīnyānqū 152
 jīnyú 294
 jīnzhāng 25
 jīpiào 213
 jīpǔfǎ 256
 jīqiāng 189
 jīqiú 224, 225, 229, 233
 jīqiúdòngzuò 231
 jīqiújú 228
 jīqiúshǒu 225, 228
 jīqiúxiàn 225
 jīqiúzìshì 232
 jīròu 16
 jīròu hànbaò 155
 jīshè 185
 jīshēn 210
 jīshíqì 166
 jīshù 165
 jīsuānjī 172, 176
 jīsuānqì 165
 jītāshǒu 258
 jīti zhǐliáo 55
 jītóu 210
 jìu 321
 jìu 308
 jìubā 150, 152
 jìubā xiāochī 151
 jìubāi 308
 jìubǎo 150, 191
 jìubāyī 150
 jìubēi 65
 jìuchí 50
 jìucōng 125
 jìucù 135
 jìudān 152
 jìuhùchē 94
 jìuhuò shāngdiàn 115
 jìuqí 223
 jìushēng liáowàngtǎ 265
 jiùshēngfǎ 240
 jiùshēngqǐjù 240
 jiùshēngquān 240
 jiùshēngtǐng 214
 jiùshēngyī 240
 jiùshēngyuán 239, 265
 jùshí 308
 jùwō 15
 jùyè 26
 jùyuè 306
 jǐwèijū 151
 jǐwèijū tiáozhìqì 150
 jǐxí cháng 34
 jǐxiè 187
 jǐxiègǔzào 202
 jǐxièshì 188, 203
 jǐxinrén dìzhì 98
 jǐyī 79
 jǐyī 210
 jǐyóu 273
 jǐyóuxiāng 204
 jǐzhè 179
 jǐzhèngshì 48
 jǐzhù ànmǒfǎ 54
 jǐzhuāngxiāng 216
 jǐzhuāngxiāng chuán 215
 jǐzhuāngxiāng gǎngkǒu 216
 jǐzhū 17
 jǐzì 23
 jǐzuò 99
 jú 230
 jú 79
 juǎn 311
 juǎnchǐ 80, 276
 juǎnfǎ 39
 juǎnfǎjiāzì 38
 juǎnfǎqián 38
 juǎnlián 63
 juǎnxīncài 123
 juǎnyángjī 214
 júbānér 126
 júbānér 126
 júbēn 254
 juélei zhīwù 86
 juésè fēnpèi 254
 juéshìyuè 259
 juéyuán jiàodài 81
 jùfēng 287
 jùfēngdēng 259
 júhuā 110
 júhuāchá 149
 jújù 122
 júlí 310
 jūnzhì 137
 júsè 274
 júyú 125
 jùyuán 254, 299
 jūzhǐ 277
 jūzì 126
 jūzì shuǐ 144
 jūzìjiàng 134, 156
 jūzìzhì 149
 K
 kābēndá(āngēlā) 817
 kābōwèilèwù 237
 kābūqīnuò kāfēi 148
 kāchē sījī 190

- kāfēi 144, 148, 153, 156, 184
kāfēi nàixī 149
kāfēibēi 65
kāfēichí 153
kāfēidǒu 144
kāfēiguǎn 148, 262
kāfēihù 65
kāfēiji 148, 150
kāfēimò 144
kāi 321
kāidiànshì 269
kāiguān 60
kāiguānqǐ 68
kāihuà guànmù 87
kāimén 260
kāipíngqǐ 68, 150
kāiqiú 233
kāiqiúqū 224
kāishǐ 321
kāisūnjiǔ 81
kāitingri 180
kāiwéide 155
kāiwèijiǔ 153
kāixíngwù 129
kāimǎilóng 317
kāiménbèi gānlào 142
kāndiànshì 269
kāngbiàn 180
kāngnàixīn 110
kāngzhòu 41
kānpéillǐjiǔ 145
kāodiàn 62
kāojiàpán 69
kāomiànāo 157
kāomiànāobōji 66
kāopán 69
kāoròu 158
kāoròuchuàn 155, 158
kāosānmíngzhǐ 149
kāoshì 163
kāoxiāng 66
kāoxiāng shóutào 69
kāozhǐ 67, 159
kātā'ěr 318
ké 129
kè 163, 310
kēcāng 214
kéchēxiāng 208
kēdiào bānshou 80
kēdóu 294
kèhù 96, 175
kèhù fúwù 104
kèhù fúwùbù 175
kēhuànpiān 255
kèhuò liǎngyòngchē 199
kei 273
kèkèfēn 148
kèlè 144
kèlǐ jièmojiàng 135
kèlǐzhuàng 132
kèlùodíyà 316
kémóluòqúndǎo 317
kěnnià 317
kèrén 64, 100, 152
kèróngjiède 109
kèshì 49
kèshidiànhuà 99
késou 44
- kètèdīwá 317
kèwèitè 318
kèxíjiǎdǎo 316
kèxué 166
kèxuèjiā 190
kèyùn mǎtóu 216
kèzhuō 162
kiu 273
kōng 321
kōngbùpiān 255
kōngchèng rényuán 210
kōngfān 235
kōnggào 94, 180
kōngjiān zhàn 281
kōngqìguòlùqǐ 202, 204
kōngquè 293
kōngquēshì 289
kōngshòuduò 236
kōngtiào 200
kōngxian 321
kōngzhītā 212
kōngzhítái 269
kōngzhōngxiǎojiè 190
kǒudài 32
kǒuhóng 40
kǒuhuán 37
kǒuliànchǐ 207
kǒuqiāng wèishēng 72
kǒuqiāngguāng 50
kǒuqiú 231
kǒuxiāngtáng 113
kǒuyǎn'ér 32
kǒuzhào 189
kú 124
kū 25
kuàbǎo 37
kuài 311, 321
kuàicān 154
kuàicāndiàn 148, 154
kuàigēnqín 124
kuàijībù 175
kuàijīn 269
kuàijīshǐ 97, 190
kuàijūn 125
kuàilè 25
kuàimén jiàn 270
kuàimén sùdù tiáojiéniǔ 270
kuàitǐng 214, 241
kuàizhuàngqiǎokèlǐbǎn 113
kuàilán 235
kuān 12, 165, 321
kuángfēng 286
kuánghuānjié 27
kuàngquán shuǐ 144
kuàngwù 289
kuānpíng diànshì 269
kuātuó 311
kūcǎorè 44
kuihuāzǐyóu 134
kuíning dùsōngzǐjiǔ 151
kuíning shuǐ 144
kuínúyǎlǐ 130
kǔjǔ 123
kǔmíng 132
kǔnbǎng xīsī 89
kǔnbǎo 184
kǔnhuò 25
kǔnnán 321
- kuòxiōng 250
kuòyinqǐ 209, 258
kuòyǔ 295
kuòzhāngshù 52
kúpǐjiǔ 145
kùzǐ 32, 34
- L
là 124
làba 201, 204
làgēncái 125
làisúotōu 317
lāji huǐshòuxiāng 51
lājiao 124, 143
lājiaofēng 132
lājiaomò 132
lājichǔlǐ 61
lājītōng 61, 67
lājixiāng 266
lālādūichāng 220
lālìan 277
làn 127
lǎnbǎn 226
lǎnbānqǐ 226
lǎnbōshì 288
lǎnchē 246
lǎnchē diàoyǐ 246
lǎndiào yīnyuè 259
lǎng 290
lǎngān 74
lǎnghuā 241
lǎngmǔjiǔ 145
lǎnhuā 111
lǎnjīqiú 231
lǎnméi 127
lǎnqiú 226
lǎnqiú qiúyuán 226
lǎnquān 226
lǎnsè 274
lǎnshéng 217
lǎnwǎng 227
lǎnwèi 18
lǎnwénnàilào 136
lào'ou 137
lǎoshì 162, 190
lǎoshìqìchē 199
lǎoshù 290
lǎotie 81
lǎowò 318
lǎtuōwéiyà 316
lǎxiāngcháng 142
lǎzhǐ 39
lǎzhù 63
léi 286
léidá 214, 281
léigài yīnyuè 259
léigū 17
lèijiānji 16
lèipái 119, 155
lèng 286, 321
lèngdòng 67
lèngdòng shípín 107
lèngdòngde 121, 124
lèngdòngshì 67
lèngquèjì róngqǐ 202
lèngquèjià 69
lèngshuǐ lóngtóu 72
lèngzhàoyǔ 135
- léngzhuǐtǐ 164
lí 126, 183
lí...yuán 320
lián'ài 26
liáng 186
liángbēi 150, 151
liángchí 109
liángdiǎn zhōng 304
liánggān 76
liángghú 69, 311
liángjiāoqǐ 165
liángqǐ dòngwù 294
liángwǎn 309
liángxié 31, 37
liàngyúshéng 76
liàngyóuji 202
liángzhōu 307
liánheshòuqǐ 182
liánhuán 36
liánhuánhuà 112
liǎnjiá 14
liǎnjié 177
liǎnkǒu 36
liǎnkùwà 34, 35
liǎnpáishì 58
liǎnpán 206
liǎnrù 136
liánsài 223
liánshānkù 30
liántóng 320
liànxi huīgān 233
liányiqún 31, 34
liányùn 212
liānzi 36
liba 85
libānèn 318
libǐlià 317
libìyà 317
lièchē shíkèbiǎo 209
lièchē zhōnglèi 208
lièxi 293
lièzhīdūnshìdēng 316
lǐfāngtǐ 164
lǐfāshǐ 39, 188
lǐhǎi 313
lǐhéqǐ 200, 204
lǐhūn 26
lǐjiāoqiáo 194
lǐjīròu 119
lǐkǒujiǔ 145
lǐliàng xùnlǎnqǐ 250
lǐliáokē 49
lǐlù 96
lǐmào 36
lǐmí 310
lǐn 293, 294
lǐnbāxitōng 19
lǐng 197, 308
lǐngdài 32
lǐngdàijià 36
lǐngfēn 230
lǐnggōu 276
lǐnggōuhuán 276
lǐnggǔ 257
- língjiāngtái 235
língjié 36
língkǒu 34
língqǐ liǎofá 55
língqǐ xínglichù 213
língshí 113
língtǔ 315
língxiàn 60
língxing 164
línjū 24
línpiàn 121
línpiàndao 299
línynù 72
línynù gélián 72
línynù gémén 72
línynù pēntóu 72
lípái lixiàn xiàngjī 270
lípíndiàn 114
lishì 162
lishì jiànzhù 261
litàowǎn 316
lǐtí 164
lǐtiē 173
lǐtíshèng 269
lǐtí 308
liùbāi 308
liùbiānxíng 164
liùbǐng 247
liùchǎn 52
liúgǎn 44
liúhuáng 289
liúlán 177
liúlǎnqǐ 177
liùshì 308
liùshù 296
liúsù huābiān 277
liúxing 280
liúxingyīnyuè 259
liúxingyīnyuè jiémù zhǔchírén 179
liúyán 100
liúyue 306
liúzuòxiāngshìchē 199
liwù 27
liyán 288
liyízhǔ 26
liyú 294
lizhì 128
lizi 129
lizi 126
lónggǔ 214
lónghào 133
lóngjiǎnfēng 287
lóngshélanjiǔ 145
lóngtou 243
lóngxiá 121, 295
loubèizhuāng 35
lǒucǎopá 88
lǒucéng 58
lǒudǒu 166
lǒuhuā píxié 37
lǒuhuājiǔ 78
lǒujié 220
lǒusháo 68
lǒutí 59
lǒutí lǎngān 59
lǒutí ménlán 75
lǒutí píngtái 59

lóuzuò 254
 lù 291
 lù 185
 lù 289
 luǎnchá 20
 luǎnpào 20
 luǎnzǐ 20
 lùbǎoshí 288
 lùbiān kāfēizuò 148
 lùbiāo 298
 lùbō 178
 lùcǎodài 85
 lùchá 149
 lùdēng 298
 lùdi 282
 lùdòu 131
 lùgānlǎn 143
 lùgǔ 17
 lùguǎn 100, 264
 lùguō 68
 lùjiǎo 291
 lùjīng 270
 lùkè 208
 lùmiànbiāozhì 194
 lùngǔ 206
 lùngǔgài 202
 lùnhuáxíe 249
 lùnjīcāng 214
 lùnquān 206
 lùntāi 198, 205, 206
 lùntāi chōngqǐjī 199
 lùntāi qiàogǎn 207
 lùnwén 169
 lùnyí 48
 lùnzhóu 205
 lùnzhóupídài 203
 luó 257
 luóbo 124
 luógānméi 127
 luòjǐ shānmài 312
 luòkèkèshì 301
 luólè 133
 luómǎnlìyà 316
 luómǔ 80
 luòqíuqū 225
 luósī dàotóu 80
 luósídào 80
 luósídǐng 80
 luòtuó 291
 luóxuánjiǎng 211, 214
 luòyè (zhíwù) 86
 luòyèsōng 296
 lúpán 67
 lùsè 274
 lùsēnbǎo 316
 lùsèshípíndiàn 115
 lùshì 180, 190
 lùshìshíwùsù 180
 lùsōngshí 289
 lútí 61
 lùtiān kāfēizuò 148
 lùwǎng 68
 lùwǎngdá 317
 lùxiàngdài 269
 lùxiàngjī 269
 lùxíng lùxiàn 260
 lùxíng tuōchē 266
 lùxíng zhípào 97

lǔxíngchē 206
 lǔxíngdài 37
 lǔxíngdàilǐ 190
 lǔxíngmótuō 205
 lǔxíngshē 114
 lǔxíngzhǐnán 260
 lùyán 298
 lùyīndiàoǎn 179
 lùyīng 266
 lùyīngdì 266
 lùyīnshì 179
 lùyīnshì 179
 lǚyóu wènxúncù 261
 lǚzhì 269
 lǚzhì 143
 lǚzhì 167

M

mǎ 185, 242, 272, 310
 mǎ'èrdàifū 318
 mǎ'èrtā 316
 mǎān 242
 mǎbiān 242
 mǎbingláng 143
 mǎbù 77
 mǎdá 88
 mǎdǎjiāsījī 317
 mǎdèng 242
 mǎèrwéināsi qúndǎo 315
 mǎfú 243
 mǎhuābiàn 39
 mǎibó 47
 mǎifū 130
 mǎikèfēng 258
 mǎipiànzhóu 157
 mǎiyácu 135
 mǎiyànyǐnlǎo 144
 mǎjiǎ 33
 mǎjiāozǐ 242
 mǎjiū 185, 243
 mǎjū 185
 mǎkèbēi 65
 mǎkù 242
 mǎláixìyà 318
 mǎlāsōng 234
 mǎlāwéi 317
 mǎlè 242
 mǎlǐ 317
 mǎlǐngshù 124
 mǎn 321
 mǎn 266, 321
 mǎn 85, 209
 mǎndiàn 59
 mēnggū 318
 mēngjiālǎguó 318
 mēngqiègē gānlào 142
 mēnhuán 59
 mēnláng 58
 mēnlángdēng 58
 mēnliàn 59
 mēnling 59
 mēnshuān 59
 mēnsuǒ 200
 mēnting 59
 mēnyá 50
 mēnzhen bingren 48
 mēnzhū 220, 222
 mǐ 130, 310

miàn 164
 miànbào 138, 157
 miànbāodào 68
 miànbāodiàn 114, 138
 miànbāoguō 124
 miànbāokuài 139
 miànbāopi 139
 miànbāoshí 139
 miànbāoxiè 139
 miànbèi 71
 miànbù 277
 miànshù 14
 miànshùlǐ 41
 miǎndiàn 318
 miándóu 131
 miànfēn 138
 miànfēnshuā 69
 miànhuā 184
 miànhuārúántáng 113
 miànji 165, 310
 miànju 249
 miànmó 41
 miànqiú 41
 miànshuāng 73
 miànshuǐ shāngdiàn 213
 miàntiào 158
 miantuán 140
 miányáng 185
 miányángnǎi 137
 miào 304
 miǎobiào 234
 miǎozhēn 304
 midíxiāng 133
 mièhuòqì 95
 mifàn 158
 mifàn bùdìng 140
 mifēng 295
 mifēngjī 83
 mifēngpíng 135
 mihóutáo 128
 mijī zhēngqiú 221
 mijian 129
 mijian bùdìng 141
 mimǎ 96
 míngǎnxíngde 41
 míngliàng 321
 míngshèng 261
 míngtiān 306, 320
 míngwǎngxíng 280
 míngxiāng 54
 míngxīnpiàn 112
 míniàokē 49
 míniàoxìtǒng 19
 mínjiān yīnyuè 259
 mínzú 315
 mipí 134
 míshèngxīhúlu 125
 miyuè 26
 mó 82
 mó'èrdūowǎ 316
 módào 187
 módaoqì 68, 118
 módaoshi 81
 mógu 125
 mójiàolán 133
 móluògē 317
 mónàgē 316
 mósāngbīkē 317

mósuǐde 132
 móte 169
 mótiān dàlóu 299, 300
 mótuōchē 204
 mótuōchē yuèyèsài 249
 mótuōchēsài 249
 mòxīgē 314
 móxing 190
 móxing zhizuò 275
 mòzélèilè gānlào 142
 MP3 bōfāngjī 268
 mù 254
 mùcái 187
 mùcái rǎnsèjī 79
 mùcǎijiāo 78
 mùchǎng 182
 mùchuí 275
 mùdǎn 111
 mùdidi 213
 mùgān 233
 mùgōng 275
 mùgōng zuàntóu 80
 mùguānyuèqì 257
 mùjiàng 188
 mùjiānxiūxi 254
 mùjīng 167
 mùlǐ 121
 mùniú 185
 mùqīn 22
 mùqún 183
 mùshào 68
 mùshù 124
 mùsì 141
 mùtàn 266
 mùtóu 79, 275
 mùxíng 280
 mùxu 297
 mùyángchǎng 183
 mùyúrú 73
 mùzhǐ 15
 mùzhìqiú 15

N

nǎi 136
 nǎichá 149
 nǎifēn 137
 nǎihé 136
 nail 320
 nǎilào 136, 156
 nǎilàopí 136
 nǎipíng 75
 nàirè 69
 nǎixī 137, 149
 nǎiyóu 137, 140, 157
 nǎiyóu dàngāo 140
 nǎiyóu xiànbīng 141
 nǎiyóudàngāo kǎomù 69
 nǎiyóudòng 141
 nǎiyóugānlào 136
 nǎiyóugāodiàn 157
 nǎiyóupàofú 140
 nǎiyóuxīngréntáng 113
 nǎizǐ 75
 nāmǐbiyà 317
 nán 312
 nánbānqió 283
 nándàyáng 313
 nánfēi 317

- nánguā 125
nánguāzǐ 131
nánhái 23
nánhuiguixiàn 283
nánmēizhōu 315
nánpéngyǒu 24
nánrén 23
nánshèng 162
nánxing 12, 13, 21
nányányuán 254
nánzhuāng 32, 105
nǎo 19
nǎozhèndàng 46
nàozhōng 70
nèibù 200
nèichédào 194
nèifenmikē 49
nèifenmixitǒng 19
nèihé 282
nèihoushíjīng 198
nèiqiānshì yíchú 171
nèitāi 207
nèitúcéng 83
nèiyè 228
nèiyìkù 32
nèiyuán 84
nèizàng 18
nènmǎlǐngshù 124
nènyuánbáicài 123
nián 306, 307
niánjí 163
niánlǎo 321
niánqīng 321
niántǔ 85, 275
niǎo 292
niàobù 75
niàodào 20
niǎogé 121
niàozhèngāo 74
nibó'ěr 318
nichán 52
niè 289
nièzi 47, 167
nǐjiālǎguā 314
nílóng 277
níngjiāo 109
níngméng 126, 151
níngméngshuǐ 144
níngméngcǎo 133
níngméngchá 149
níngméngjiàng 134
nǐrièr 317
nǐrǐlià 317
nǐshuǐ 239
niúdù 185
niūkòu 32
niúnǎi 136, 156
niúnǎi kāfēi 148
niúnǎi qiǎokèlì 113
niúròu 118
niúshāng 46
niúshàngyāopái 119
niúshé 118
niútǔpái 119
niúzǎijīngjī biàoyǎn 243
niúzǎikù 31
niúzhì 133
nóngchǎng 183, 184
- nóngchàngyī 182
nónghuó 183
nóngjiā chāngyuán 182
nóngliè hēipíjiù 145
nóngmín 182, 189
nóngshè 182
nóngtián 182
nóngzuòwù 184
nuǎnfēng kāiguān 301
nuǎnqiàpian 60
nuǎnshuǐdài 70
nǔér 22
nǔféngrenshì 191
nǔhái 23
nuówei 316
nǔpéngyǒu 24
nǔrén 23
nǔshāngren 175
nǔshèng 162
nǔshì chènshān 34
nǔshì duǎnfā 39
nǔshì duǎnshàngyī 35
nǔshìzhè 191
nǔshuǐyī 35
nǔxíng 12, 20
nǔxù 22
nǔyányuán 254
nǔyòng cháng shuǐyī 35
nǔyòng nèikù 35
nǔyòng nèiyī 35, 105
nǔzhuāng 34, 105
nǔzhūrén 64
- ōuqín 133
òutù 44
ōuzhōu 316
ōuzhōufángfēnggēn 125
- P
pá 90
pà'èrmǎ gānlǎo 142
pái 210, 254
pài 143
páidēngjié 27
páigǔ 119
pǎilèi yùndòng 231
páilǔàn 20, 52
páiqiguān 203, 204
páiqiú 227
páiqixiāoyīnqǐ 203, 204
páishuǐ 91
páishuǐfá 61
páishuǐgōu 299
páishuǐguān 61
pán 230
pānbǐng 247
pāndēngjià 263
pàng 321
pángguāng 20
pángxiè 121, 295
pànjué 181
pànxíng 181
pānyán 248
pānyuán zhiwù 87
pánzi 65
páo 79
pǎobùjī 250
- pǎochē 199
páodào 212, 234
pǎolèi 229
pāomáo 217
páomiàntú 282
pàomò 148
pàopào yuè 73
pǎoqiú 221
páoxíng dòngwù 293
pázi 88
pèicài 153
pèidiànqǐ 203
pèijīngshì 51, 189
pèiǒu 23
pèishètuán 180
pèishènxī 180
pèishi 36
pèitāi 52
péiyàngmǐn 166
pēnfā 283
péngkè yīnyuè 259
péngren 67
péngtiáo shǒufā 159
péngquànqǐ 89
péngwū 85
péngyǒu 24
pénhú 89
pénhuā 111
pénquán 85
pēnshuǐ 91
pēnshuǐkǒng 290
pēnshuǐqǐ 199, 311
pēntǐ 44
pēntóu 89
pēnwǔguān 311
pēnwùqǐ 89, 109
pénzāi zhiwù 87, 111
pēnzui 89
pí 119, 128
pǐ 237
piànmáyán 288
piántóutǒng 44
piányi 321
piànzhuàng 132
piàobáiji 77
piáo chóng 295
piào xi 76
pífá 241
pífú 14
pífú báixī 41
pífú huì 108
pífúkē 49
píhuàtǐng 241
píjīn 173
píjiǔ 145, 151
píjiǔ lóngtóu 150
píncǒurénxiàng 181
píndào 178
pínféng 277
píng 135, 311
píngdí rénzi tuòxié 57
píngdǐbōlibèi 65
píngfáng 58
píngfáng mí 310
píngfáng yǐngchǐ 310
píngfēn 163, 230
píngguō 126
píngguō quèhèqǐ 68
- pingguōcù 135
pingguōjiǔ 145
pingguōzhǐ 149
píng hēngmù 235
píngjiǔ 223
pingmiàntú 261
pingmiàntúxíng 164
pingmù 97, 176
pingmù zuàntóu 80
píngpāngqiú 231
píngpāngqiúpài 231
píngsāi 166
pingxíng 165
pingxíngsìbiānxíng 164
pingyuán 285
pingzhí 165
pingzhuāngshípǐn 134
pingzhuāngshuǐ 144
píngzǐ 61
pínlǚ 179
píntiē 275
píntǔ 273
píntuō 311
pínxìé 162
pínzi yóuxi 272
pítǎbǐng 139
pixiè 32, 27
piyí 205
pizàng 18
pizhèn 44
pōufúchǎn 52
pōyāngshuǐ 52
pùbù 285
pūcǎopí 90
pūdi fāngcháobù 267
púfú zhiwù 87
púgōngyǐng 123, 297
púguāng 271
púguāng búzú 271
púguāng guòdù 271
pūkèpái 273
pūlāti 250
pùmian 85
pútáo 127
pútáogān 129
pútáogānmiànbāo 139
pútáojiǔ 145, 151
pútáoshù 183
pútáoyá 316
pútáoyòu 126
pútáoyuán 183
pútáozhǐ 144
pútáozǐyóu 134
pūzhuān 82
- Q
qí 221, 232
qí 308
qián'ānqiáo 242
qián'é 14
qián'èdài 242
qiánbào 37
qiānbǐ 163, 275
qiānchā 207
qiānchuíxiàn 82
qiándēng 198, 205
qiándīlǎn 88
qiánfēng 222
- qiáng 186
qiángbi 58
qiángfēng hángxíng 241
qiánglizhǐjiá 173
qiángqǐjiǔ 230
qiángshǒuqǐ 272
qiángzhuàng 321
qiánjiá 37
qiānjīndǐng 203
qiánjiùchǐ 50
qiānkè 310
qiánlièxiàn 21
qiánlún 196
qiánmǎ 297
qiánmén 58
qiánmíng 96, 98
qiánnián 307
qiánqīlǚjià 210
qiánqíú 234
qiánshuǐ miànzhào 239
qiánshuǐfú 239
qiánshuǐqǐ 239
qiánshuǐtǐng 215
qiántiān 307
qiántiáo 89
qiánzhèng 213
qiánzhui 244
qiánzǐ 167
qiāokèlì 113
qiāokèlì cuipiàn 141
qiāokèlì dāngāo 140
qiāokèlì nǎixi 149
qiāokèlìhé 113
qiāokèlìjiàng 135
qiāokèlìqíú 113
qiáoliáng 300
qiáopái 273
qiāoqiāobǎn 263
qībǎi 308
qīchē 207
qīchē 198, 200, 202
qīchē lǎisài 249
qīchē xiūlǐzhàn 199
qīchē xuánjià 203
qīchē yǐnxiàng 201
qīchuíuáng 71
qídài 52
qidiànchuán 215
qíé 292
qiēdá gānlǎo 142
qiēgé 79
qiēgēdào 81
qiēguǎnjī 81
qiējī 233
qiēkuài 119
qiēpiàn 67, 139, 140
qiēpiānde 121
qiēpiānjī 139
qiēpiānmiànbāo 138
qiērouchā 68
qiēroudào 68
qíézi 125
qífēi 211
qīgānggài 202
qīguān 18
qīháng 217
qījūshì 62
qīkān 168

- qīluòjià 210
 qímǎ 263
 qímǎ zhuānyòngdào 263
 qímèi(jiè) 23
 qímèi(jiè)fū 23
 qímén 207
 qíméngān 247
 qínbao 220, 221
 qíncài 122
 qīng 321
 qīngbiàn zhédìetāngyī 165
 qīngchú zácáo 91
 qīngdòu 131
 qīngfú 241
 qīnggǎn 25
 qīngjī 233
 qīngjiāchēsài 243
 qīngjiégōng 188
 qīngjiéjī 77
 qīngjiéyè 51
 qīngjiéyòngjù 77
 qīnglú 24
 qīngqī 79, 83
 qīngsào 77
 qīngshàonián 23
 qīngtíng 295
 qīngxíng fēiji 211
 qīngyú 120
 qīngzhēng 159
 qīngzhēnsi 300
 qīngzhū dàngāo 141
 qīngzhùhuì 140
 qínjīng 258
 qínǎ 258
 qínqī 23
 qínrou 119
 qípán 272
 qípán yóuxi 272
 qípào xiàn 234
 qípàoqi 234
 qīshì 308
 qīshòu 242
 qīshòumào 242
 qīsù 94
 qītā diànpù 114
 qītā gōngyī 275
 qītāchuánxíng 215
 qītāyùndòng 248
 qītóng 207
 qiú 75, 221
 qiúbàng 225, 228, 249
 qiúchǎng 226, 227, 228
 qiúdào 232
 qiúdòng 232
 qiúduì 220, 229
 qiúgān 224
 qiújīnggānlán 123
 qiújīngzhíwù 86
 qiújiù diànhuà 195
 qiújiù 233
 qiúlán 226
 qiúling 284
 qiúmén 221, 222, 223, 224
 qiúmén héngliáng 222
 qiúmén qū 223
 qiúmén xiàn 220, 223, 224
 qiúménqū 220
 qiúpāi 230
- qiúpāibǐng 230
 qiúpāimián 230
 qiúpāiwǎngxiàn 230
 qiúqiān 263
 qiúti 164
 qiútiān 31, 307
 qiútóng 231, 233
 qiúwǎng 222, 226, 227, 231
 qiúxié 220, 223
 qiúyīhào 226
 qiúyīn 295
 qiúyuán 220, 221
 qiúzuò 233
 qiwūjī 44
 qiyóu 199
 qiyóubèng 199
 qiyyè 306
 qizhòngjī 187, 216
 qizhuàngzhī 290
 qizi 272
 qizi 22
 qizixīngchē 263
 qù sípí 41
 quǎnchǐ 50
 quǎnqī 236
 quǎnjiǐ bǐsài 237
 quǎnjiǐ liànxi 237
 quǎnjiǐ shòutào 237
 quǎnjiǐ tái 237
 quǎnjīngzhào 271
 quǎnmàimiànbǎo 139
 quǎnmàimàiměnfēn 138
 quǎntóu 15, 237
 quǎnxiézhēn 173
 quǎnbīng 203
 quǎnchǐ 50
 quǎnchóngjī 108, 267
 quǎndòngzhōu 202
 quǎnbān 15
 quǎnguāngdù 51
 quǎngūde 121
 quǎngūntèi yùndòng 224
 quǎngūnqū 224
 quǎngūnqū bàng 224
 quǎngyúpiàn 121
 quǎnjīngqī 271
 quǎkédé 129
 quǎkuāndān 96
 quǎlīnde 121
 quǎnbīan 34
 quǎnzi 30, 34
 quǎpide 121
 quǎpíxiā 120
 quǎwūfēn 77
 quǎyū 299
- R**
 rǎnfàji 40
 rǎnqīqī 61
 rǎnsède 39
 rǎnyóuxiāng 204
 ráogū 17
 ràoxiànzhōu 276
 ràoxīngdàolù 195
 rè 286, 321
 rècéng 286
 rèdài 283
 rèdàishuiguō 129
- règǒu 155
 rèlātuómáo 41
 rén 78, 89
 rén 12, 16
 rěndài 17
 rěndǒng 297
 rénjiuguānxī 24
 rénlǐzìyuánbù 175
 rénqiáng 222
 rěnsēn jiǎnchá 52
 rěnsēngdàshì 26
 réntǐ 12
 réntǐ móxíng 276
 réntíxītóng 19
 rénxìangzhào 271
 rénxíngdào 298
 rénxínghéngdào 195
 rényǎnqū 222
 rénzàoěr 244
 rénzàohuángyóu 137
 rénzàowèixíng 281
 rèqiǎokèlì 144, 156
 rèqīqiú 211
 rěshēn 250
 rěshuǐ lóngtóu 72
 rěyīn 144
 rì 306
 rìbēn 318
 rìchéng 261
 rìchū 305
 rìguǐ 262
 rìlì 306
 rìluò 305
 rìqī 306
 róngbù niàobù 30
 róngjī 83
 róngjī 311
 róngliàng 311
 róngqī 311
 róngxiù 277
 róngyán 283
 róngyī 321
 róngyuán 294
 ròu 118
 ròudào 236
 ròudiànlaobǎn 118
 ròudoukǒu 132
 ròudoukǒuyī 132
 ròuguī 133
 ròujiàng 142, 156
 ròupí 119
 ròupù 114
 ròuqīn 107
 ròutāng 158
 ròuwán 158
 ròuxiàn 119
 ròuzhī zhíwù 87
 ruǎn 129, 321
 ruǎn yīnlǎo 144, 154
 ruǎngāo 109
 ruǎngū 17
 ruǎnguān 311
 ruǎnjiàn 176
 ruǎnmiànbǎopiàn 139
 ruǎnmù 79
 ruǎnmùsāi 134
 ruǎnnǎilào 136
 ruǎnpán 176
- ruǎnxīndòulítāng 113
 rúchǎngfēi 260
 rúdiàn 53
 rúfáng 12
 ruidiǎn 316
 ruishì 316
 rújīngjiǎnchá 212
 rúkǒu 59
 rùnfùlù 73
 rùnhóupiàn 109
 rǔniúchǎng 183
 rǔshì dàoqiè 94
 rǔshuǐ 71
 rǔtáng 137
 rǔtóu 12
 rǔxué 26
 rǔzhīpīn 107
 rǔzhīpīn 136
- S**
 sà'ěr wādūo 314
 sàixīngdào 316
 sǎhālā shāmò 313
 sāi 294
 sà'ěr wéiyà 316
 sàichē 205, 206, 249
 sàichēshòu 249
 sāihóng 40
 sāilǎiliáng 317
 sàimǎ 243
 sàimǎ(bìsài) 243
 sàimǎchǎng 243
 sàinèijǐjiǎ'ěr 317
 sàipào 234
 sàipǔlǔsī 316
 sàishì 243
 sāixiànyán 44
 sāixù 290
 sāizi 72
 sàkèsīgǔǎn 257
 sàlǎmǐ xiǎngchǎng 142
 sǎn 36, 233
 sān 308
 sānbǎi 308
 sāncéng 104
 sānfēnxiàn 226
 sāngnáyú 250
 sāngguāng 51
 sānji 109
 sānjiǎobǎn 165
 sānjiǎoji 16
 sānjiǎojià 166, 270, 281
 sānjiǎoméi 301
 sānjiǎonèikǒu 33
 sānjiǎoqiáng 300
 sānjiǎotiè 257
 sānjiǎoxíng 164
 sānlóu tíngzúo 254
 sānmén 200
 sānménzhù 225
 sānmíngzhì 155
 sānmíngzhì guitái 143
 sānrèqī 202
 sānshì 308
 sāntóujī 16
 sānxiāngchē 199
 sānyuè 306
 sāochú 77
- sāomiáoyī 176
 sǎwǎng 245
 sǎzīmìànbǎo 139
 sèdiào 41
 sēnlín 285
 shā 264
 shābǎo 265
 shābù 47
 shāchē 200, 204, 206, 207
 shāchēpiàn 207
 shāchētàbǎn 205
 shāchóngjī 89, 183
 shāchuí 257
 shādài 237
 shādingyú 120
 shāfā 62
 shāfāchuāng 63
 shāguō 69
 shāi 91
 shāi rìguāngyú 264
 shāihòu hǔfūyè 108
 shāisǎ 138
 shàishāng 46
 shāizi 89
 shāikēng 232
 shāilā 149
 shāmò 285
 shān 284
 shānbèi 121
 shāndiàn 287
 shāndìchē 206
 shàngcài 64
 shàngchuán 217
 shàngchuāng shuǐjiào 71
 shàngdiàn 298
 shàngè 19
 shàngguāng 77
 shàngguāngjī 77
 shàngjiāngshuā 82
 shāngkǒu 46
 shānggrén 175
 shāngsù 181
 shāngǔ 284
 shāngguāngdēng 270
 shāngwù 175
 shāngwúcāng 211
 shāngwùlǔxíng 175
 shāngxiàbàn gāofēngqī 209
 shāngyèjiāoyī 175
 shāngzhōu 307
 shāngzhuāng 32, 34
 shānhújiāo 285
 shānmài 282
 shānmàoju 296
 shānpō 284
 shānyáng 185
 shānyángnǎi 136
 shānyángnǎilào 142
 shānyào 125
 shānyè 60
 shānzhūguō 128
 shāobēi 167
 shāokǎo 67
 shāokǎojià 267
 shāopíng 166
 shāoshāng 46
 shātè'àlǎbō 318

- shātū 85
 shāxiāng 263
 shāyán 288
 shāyú 294
 shāzhǐ 81, 83
 shé 19, 293
 shédìng nàozhōng 71
 shèjī 249
 shèjiàn 249
 shèjīngguān 21
 shèjìshī 277
 shémén 223
 shèn 119
 shēnfēnbiāoqiān 53
 shēng 315
 shēng 124, 129, 311
 shēng miàntuán 138
 shēnggāoji 45
 shēngbīngde 321
 shēngdài 19, 255
 shēngdānjié 27
 shēngduōmèi hé pǔlínxībī 317
 shēnghào 256
 shēngjīcí hé níwéisī 14
 shēnglúxiyà 314
 shēngmǎlinuò 316
 shēngri 27
 shēngri dàngāo 141
 shēngri jùhui 27
 shēngri làzhú 141
 shēngròu 142
 shēngsuò 207, 248
 shēngtán 301
 shēngwénsèntè hé gélínnàdīngsī 314
 shēngwùxué 162
 shēngyīhuòbàn 24
 shēngzhī 20
 shēngzhìqī 12
 shēngzhìqīguān 20
 shēngzhìxītóng 19
 shēngzī 26
 shēnhǎi chuídiào 245
 shēnhèshè 39
 shénjīng 19, 50
 shénjīngkē 49
 shénjīngxītóng 19
 shēnkǒu yuánchí 68
 shēnshuǐqū 239
 shènzàng 18
 shēnzhān 250
 shēnzhāntuī 250
 shèxiàngjī 178
 shèxiàngjī shēngjiàngqī 178
 shèxiàngshí 178
 shèyǐng 270
 shèyǐngshī 191
 shí 280, 308
 shí'èr 308
 shíbā 308
 shíbing 189
 shíchāng 115
 shíchāngbù 175
 shíchūang 177
 shídài 23
 shíèryuè 306
 shièrzhicháng 18
 shíféi 91
 shígāo 83
 shígōng zuàntóu 80
 shìgù 46
 shìguān 19, 166
 shìguānjià 166
 shìhuìshì 85
 shìhuìyán 288
 shìjī 307
 shìjiàn 234, 304
 shìjiè ditú 312
 shìjīnshālā 158
 shìjiū 308
 shìkèbiào 197, 261
 shìli 51
 shìli jiānchá 51
 shìliú 128
 shìliú 308
 shìliúshí 288
 shìlú 133
 shīmǎn 71
 shīmǎnlǜ 85
 shímò 289
 shínánhuà 297
 shìnèi biānpào 31
 shìnèi xītóng 60
 shìnián 307
 shípín 105
 shípín jiāgōngqī 66
 shípín yóuxi 269
 shípín zǎhuò 106
 shípíntān 154
 shípínzǎhuòdiàn 114
 shìqī 308
 shìqū 299
 shìrùn 286
 shísān 308
 shísàng 277
 shìshèngjī 31
 shísì 308
 shítou 275
 shíwàn 309
 shíwǎngmó 51
 shíwù 118, 149
 shíwù 308
 shíwùlǎn 263
 shíyàn 166
 shíyànshì 166
 shíyī 309
 shíyī 308
 shíyǐng 289
 shíyǐnqī 258
 shíyíyù 306
 shíyòng shuōmíng 309
 shíyù 306
 shìzhè 148, 152
 shìzhèn 304
 shìzhèn 44
 shìzhèngtǐng 299
 shìzhí 15
 shìzhìjīn 74, 108
 shìzhōng shōuyǐnjī 70
 shìzhuāngdiàn 115
 shìzi 128
 shìzi 291
 shìzìlùkǒu 298
 shòu 321
 shǒu 13, 15
 shòubi 13
 shòubiào 36
 shòubǐng 61
 shòuchā 89
 shòudòng 200
 shòudù 315
 shòufèi pǐndào 269
 shòufèizhān 194
 shòuhòu 91, 183
 shòuhuòyuán 104, 188
 shòujiànlan 172
 shòujiànxiāng 177
 shòujǐng 20
 shòujù 81, 89
 shòujù 152
 shòukào 94
 shòukuānjī 106, 150
 shòukuántái 106
 shòulèiyuán 228
 shòulún 276
 shòuményuán 222, 224, 225
 shòupà 36
 shòupiāochù 209, 216, 255
 shòuqiāng 94
 shòuqū 229
 shòuròu 118
 shòusān jiāofān 240
 shòushāchē 203
 shòushì 36
 shòushidiàn 114
 shòushìhè 36
 shòushù 48
 shòushù jìlùbiào 48
 shòushùshì 48
 shòutào 36, 224, 233, 236, 246
 shòutǎo 37
 shòutǎnshì yǐng'érchuāng 75
 shòutǎnxínglǐ 208, 213
 shòutuīchē 208
 shòuwán 13, 15
 shòuxiàn 245
 shòuyǎn 254
 shòuyáo qǐbēngzuàn 78
 shòuyáozaun 81
 shòuyī 189
 shòuyīnjī 268
 shòuyīnyuán 106
 shòuzhǎng 15
 shòuzhìde 48
 shòuzhuò 36
 shù 86, 296
 shù 168, 273
 shuāi 237
 shuāidào 237
 shuāigān 76
 shuāigānjī 76
 shuāijiào 236
 shuāng 287
 shuāngbàotāi 23
 shuāngcéng gōnggōngqīchē 196
 shuāngdǎ 230
 shuāngfēn 151
 shuāngfúshuǐ 41
 shuānggàng 235
 shuāngguāngde 51
 shuānghuāngguān 257
 shuāngjī 109
 shuāngmén 200
 shuāngmén bīngxiāng 67
 shuāngrénchuāng 71
 shuāngrénjiàn 100
 shuāngshēnfēn 73
 shuāngtào mǎchēsài 243
 shuāngtǐchuān 215
 shuāngtǒng wàngyuānjǐng 281
 shuāngyèjiàng 241
 shuāngyī fèiji 211
 shuāngzú zìxíngchē 206
 shuānji 109
 shuāqī 83
 shuātóufā 38
 shuāxi 77
 shuāyá 50
 shuāzì 83
 shūbào 162
 shūbiao 176
 shūcǎi 107, 122, 124
 shūcǎi bǎoxiāngé 67
 shūcǎi hǎnbào 155
 shūcǎi shālà 158
 shūcǎi shuǐguòdiàn 114
 shūcǎi shuǐguòshāng 188
 shūdài xióng 291
 shūdiàn 115
 shūfáng 63
 shūfú 35
 shùgǎn 296
 shuǐ 96
 shuǐ 144
 shuǐbà 300
 shuǐcǎi huàyuánliào 274
 shuǐchǎndiàn 114, 120
 shuǐdài 267
 shuǐdào 184
 shuǐdiàn 267
 shuǐdòu 44
 shuǐfèi qiánshuǐ 239
 shuǐguān 151
 shuǐguān 202
 shuǐguānchē 89
 shuǐguò 107, 126, 128
 shuǐguò dàngāo 140
 shuǐguò xiànbǐng 140
 shuǐjǐng huàyuán 84
 shuǐjǐng liáofǎ 55
 shuǐliáo 55
 shuǐlóng 95
 shuǐlóngtóu 61, 55
 shuǐmián 74
 shuǐmù 295
 shuǐní 186
 shuǐníjiāobànqī 186
 shuǐnuǎngōng 188
 shuǐpào 46
 shuǐpíng 206, 267
 shuǐpíngwéiyī 210
 shuǐpíngyī 80
 shuǐqí 239
 shuǐshàng fèiji 211
 shuǐshàng mótuō 241
 shuǐshàng yùndòng 241
 shuǐshèng zhìwù 86
 shuǐshòu 189
 shuǐtǎ 290
 shuǐtǒng 77
 shuǐxià hūxiǎguān 239
 shuǐxiāng 61
 shuǐxiàng 280
 shuǐyī 31, 33
 shuǐyītǐng 215
 shuǐzhàngài 232
 shuǐzhù 95
 shuǐzhù 159
 shuǐzhūnyī 187
 shǔjià 63, 168
 shǔjià 273
 shǔjiànguān 180
 shǔjǐngguān 21
 shǔkǒuchi 50
 shǔkǒuyè 72
 shǔlǐ 85, 90, 182
 shǔlín 285
 shǔluǎnguān 20
 shǔmù xiàngjī 270
 shǔmíng 168
 shǔmù 168
 shǔmù zhìzhuàng 90
 shǔniàoguān 21
 shǔnshì liáofǎ 55
 shǔcǎi shuǐguòshāng 259
 shuòshìxuéwèi 169
 shūpī 296
 shūpiàn 113
 shūqín 256
 shúrén 24
 shúròu 118, 143
 shúshì 107
 shúshìdiàn 142
 shútào 154, 155
 shútóu 38
 shǔwéicǎo 133
 shǔxué 162, 164
 shǔyè 53
 shǔzhi 296
 shǔzhuāngtái 71
 shǔzi 308
 shǔzishi 269
 sì 308
 sībāi 308
 síchóu 277
 sīdǎi 39, 235
 sīguānló 73
 sījī 196
 sījīdòu 122
 sīliàocáo 183
 sīlǐlǎnkā 318
 sīlúnqūdòng(chē) 199
 sīlúfákè 316
 sīlúwénnià 316
 sīmǎn 200
 sīmào 300
 sīqūxiàn 221
 sīrén jiàoliàn 250
 sīrén pēnqìshì fèiji 211
 sīshí 308
 sīshí fēnzhōng 304
 sītóujī 16
 sīwáng 26
 sīwéishìlǎn 317
 sīyǎng 183
 sīyuè 306
 sōngbīng 140
 sōngbīng kǎopán 69

sòngcān 154
 sōnggāo 140
 sōngjiéyóu 83
 sōngjīn wàdài 35
 sōngróuchuí 68
 sōngshù 296
 sōngshù 290
 sōngtǔ 91
 sōngzhìqì 172
 sōngzǐ 129
 sōusuǒ 177
 suān 127
 suānbàn'er 125
 suānchéng 126
 suāncù tiāowèizhī 158
 suānlàijiàng 135
 suānmiànbāo 139
 suānmó 123
 suānnāi 137
 suānnāiyóu 137
 suànshù 165
 suànwèilācháng 143
 sūdǎ miànbāo 139
 sūdǎ shuǐ 144
 sūdān 317
 sùdì 99
 sùhuá 247
 suǐjǐ cúnchúqì 176
 suǐlǐxiàomài 130
 suǐnǎilào 136
 suǐshì 88, 288
 sùjǐyuán 181
 sùliào niàokù 30
 sùliàodài 112
 sùliàohé 321
 sùlínán 315
 sùmiáo 275
 sùmiáobù 275
 sùn 292
 sūnnǚ 22
 sūnzǐ 22
 sūnzǐnǚ 23
 suǒ 59
 suǒgǔ 17
 suǒguì 239
 suǒluómén qúndǎo 319
 suǒmǎlǐ 317
 suǒxiǎo 172
 sùsóng ànjìàn 180
 sùsòngwèituōrén 180
 sùyíngdì 266

T

tǎ 300
 tàbǎn 61
 tàbùjǐ 250
 tàdēng 217
 tài'er 52
 tàifèitáng 113
 tàiguó 318
 tàijíquán 237
 tàikōngfú 281
 tàimiàn 207
 tàipán 52
 tàipíng yáng 312
 tàiqián 78
 tàiqiú 249
 tàiquán 236

táiquándào 236
 tàitài 23
 táiwǎn 319
 tàiyā 203
 tàiyáng 280
 tàiyángjīng 51, 265
 tàiyángxì 280
 tàiyángxuè 14
 tàijiāotào 207
 tàijìkèsītǎn 318
 tànbǐ 275
 tāng 153, 158
 tāngchí 65
 tāngfā 39
 tāngguǒ 113
 tāngguódiàn 113
 tāngjiāng 109
 tāngláng 295
 tāngniàobīng 44
 tāngpén 65
 tāngshuāng 141
 tánhuáng 71
 tánhuángchéng 166
 tānsāngnià 317
 tànsǐ shǐjiān 48
 tànsuān 144
 tànxì 25
 tànyuán 94
 tànzhen 50
 tànzǐ 71, 74
 táo 126, 128
 táocǐ cǎnjū 64
 táocǐ lútái 66
 tàojiàodài 241
 tàolún 163
 tàotǒng 80
 tàotǒng bànsou 80
 tàotóumáoyǐ 33
 tàoyǐ 275
 tàozhìdùnguǒ 69
 tàsīmānià(ǎo) 319
 tàuyǐ 120
 tèjìtiàosǎn 248
 tèlínidá hé duóbāgē 314
 téngjià 84
 tèsecài 152
 tí 291
 tí'àn 174
 tián 124, 127
 tiáncài 125
 tiánchōngwù 50
 tiānchuāng 202
 tiāndì 182
 tiāndiǎnpán 65
 tiānè 293
 tiānguā 127
 tiānhuābǎn 62
 tiānjiàng 134
 tiānjiào 124
 tiānjīng xuānshǒu 234
 tiānjīng yùndòng 234
 tiánliào 83
 tiānpíng 166
 tiānqì 286
 tiānrán xiānwéi 31
 tiānshí 107
 tiānshí xiǎochē 152
 tiānshìdiàn 113

tiānwángxíng 280
 tiānwéide 155
 tiānwén wàngyuánjīng 281
 tiānwénxuè 281
 tiānxián gǎnlǎn 143
 tiányécài 123
 tiányumǐ 122
 tiàobǎn 235, 238
 tiàogāo 235
 tiàojiào 271
 tiàojiào xuānniǚ 167
 tiàomǎ 235
 tiàoqiú 226
 tiāorǎn 39
 tiāosǎn 248
 tiáosèbǎn 274
 tiàoshèng 250
 tiàoshuǐ 238, 239
 tiàoshuǐ xuānshǒu 238
 tiàotái huáxuè 247
 tiàotǐ 237
 tiàotóu 227
 tiáowēi 159
 tiáowēipín 135
 tiáowèizhǐ 135
 tiáoxíngmǎ 106
 tiáoxíngmǎ sāomiàoqi 106
 tiáoyǎn 179
 tiàoyuán 235
 tiàoyuè 243
 tiáozhìjiētíàoqi 176
 tiàozhìyuán 223
 tícǎo 235
 tícǎo xuānshǒu 235
 tidài liáofā 54
 tidào dǎopiàn 73
 tiē 109, 289
 tiē (qiángzhǐ) 82
 tiēbǐng 234
 tiēbìzhǐ 82
 tiēgān 233
 tiēguǐ 208
 tiēlǔwǎng 209
 tiēqiāo 187
 tiēsījiān 81
 tígōng zhùsù hé zǎocǎn 101
 tíhù 292
 tíjǐ 165
 tíjiàn 45
 tikuǎnjǐ 97
 tíngbó 217
 tíngchē 195
 tíngchē ànniǚ 197
 tíngchē jǐshì shǒufèiqì 195
 tíngchēchǎng 298
 tíngdiàn 60
 tíngjǐng 180
 tíngjǐpíng 212
 tíngtǒng 99
 tíngyuán 261
 tíngyuán 58, 84
 tíngyuán 241
 tíngzhènqì 45
 tíngzhǐ 269
 tíqiú 221, 223
 tǐshǒu 37, 106
 tiwén 163
 tiwēnjǐ 45

tíxíng 164
 tìxū 73
 tìxūpàomò 73
 tiyù 162
 tiyùchǎng 223
 tiyùyùndòng 105, 220
 tìzhōngjì 45
 tìzì 186
 tóng 289
 tǒng 82, 265
 tǒngfēngkǒu 210
 tǒngguān yuèqì 257
 tonghuā 273
 tǒngkǒng 51
 tǒngpái 235
 tǒngshēn 61
 tǒngshì 24
 tǒngwéncéng 286
 tǒngxùn 98
 tǒngzhuāng 30
 tóu 12
 tóubidiànhuà 99
 tóubìshì zìdòngxiyídiàn 115
 tóubù 19
 tóubù sūnshāng 46
 tóudǐng suǒguì 210
 tóufa 14, 38
 tóujǐngbù sūnshāng 46
 tóukuǐ 95, 204, 206, 220, 228
 tóukuǐmiànzhào 205
 tóulán 227
 tóumíngjiāodài 173
 tóupi 39
 tóupixiè 39
 tóuqiú 222, 225, 229
 tóuqiúqū tūdūn 228
 tóuqiúshǒu 225, 229
 tóushā 35
 tóutǒng 44
 tòuzhǐ 96
 tóuzǐ 272
 tóuzǐ 97
 tóuzǐ gùwèn 97
 tǔ'èrqì 316
 tuántǐlǚyóu 260
 túbiāo 177
 túbiāo shífēi 90
 túbùxuè 267
 túdǐng 173
 túdǐng 39
 túhù 188
 tuī 12, 13, 119
 tuībikǒu 99
 tuìgān 233
 tuìjiànshù 168
 tuìjīnqì 281
 tuìxiú 26
 tǔkùnmǎsītǎn 318
 tún 13
 tūnisì 317
 túnjǐ 16
 tuōbā 77
 tuōchē 203, 266
 tuōchuán 215
 tuófēng 291
 tuōjū 35
 tuólājǐ 182
 tuóniǎo 292

tuōpǎn 152, 154
 tuōshuǐde 129
 tuōxié 31
 tuōyuánxíng 164
 tuōzhǐ nǎiyóu 137
 tuōzhǐ niú'nǎi 136
 tuōzōu 195
 tǔrǎng 85
 tǔròu 118
 tǔshǔguān 168, 299
 tǔshǔguānlǚyuán 168, 190
 tǔxing 280
 tǔzǐ 290
 Txùshān 30, 33

V

Vxínglíng 33

W

wā 90, 294
 wàibì 97
 wàibì duìhuànchù 97
 wàibiào 30
 wàibù 198
 wàichédào 194
 wàichū 75
 wàichū jiùcǎn 148
 wàidài 154
 wàifǔ qiǎokèlì 140
 wàihé 282
 wàihùshǔjīng 198
 wàikè 130
 wàikè 49
 wàikè yǐshēng 48
 wàipí 126, 142
 wàishēng 23
 wàishēngnǚ 23
 wàisūnzǐnǚ 23
 wàitào 32
 wàitúcéng 83
 wàiyè 229
 wàiyìcéng 286
 wàiyǐn qièkǎishù 52
 wàizǔfǔmǔ 23
 wǎjuéjǐ 187
 wǎn 273
 wǎn 65
 wǎncǎn 64
 wǎncǎn càidān 152
 wǎndiàn 209
 wǎndòu 122
 wǎng 272
 wǎngbù 245
 wǎngluò 176
 wǎngpái 273
 wǎngqiú 230
 wǎngqiúchǎng 230
 wǎngqiúshǒu 231
 wǎngqiúxié 231
 wǎngzhàn 177
 wǎnjia 273
 wǎnjù 75, 105
 wǎnjǔlán 75
 wǎnjǔwú 75
 wǎnlǐfú 34
 wǎnqú 165, 250
 wǎnshèngjié 27

- wánwūtú 319
wánzhèng 129
wǎpiàn 58, 187
wǎqīngān 233
wáwa 75
wáwáwū 75
wáyōng 239
wázi 33
wèi 320
wèi 290, 292, 294
wèi 18
wèi jīngguò bāshìxiàodúde 137
wèi mǔrú 53
wèiba 242
wèibólú 66
wèibù 121
wèibùchémén 198
wèichāng 243
wèidēng 204, 207
wèidimālā 314
wèidóu 30, 50
wéigān 240
wèihūnfú 24
wèihūnfúqī 24
wèihūnqī 24
wéijīn 31, 36
wéilán 182
wèinèiruiliā 315
wéiqún 69
wèishēng hùdiàn 108
wèishēng miántiáo 108
wèishēngjiān 104, 266
wèishēngjīn 108
wèishēngsù 108
wèishēngzhǐ 72
wèishìjī 145
wèishúde 129
wèitōng 44
wèixiàn 283
wèixiàn 195
wèixiào 25
wèixīng dǎohángyí 201
wèixīng diànshì tiānxiàn 269
wèixīngchē 199
wéiyì 210
wèizhuī 17
wèizuí 30
wèn 293
wèndìnglún 207
wèndù 286
wèndùjī 167, 201
wénjiàn 177
wénjiànguī 172
wénjiànché 173
wénjiànjiā 172, 177
wénjù 105
wénlái 319
wènnuǎn 286
wénpíng 169
wénshēn 41
wénshì 85
wèntí 163, 171
wénxiàngbǎn 241
wènxué 162, 169
wénxúnchū 168
wénzhàng 267
wénzi 295
- wénzi xùnxī 99
wōjū 123
wólúnzēngyǎqī 203
wōniú 295
wòpùchēxiāng 209
wòshì 70
wòshìyīng'érchē 75
wù 287
wǔ 308
wǔbǎi 308
wǔbiānxíng 164
wǔcǎn 64
wǔcǎn càidān 152
wúdài biànxíe 37
wúdǎoxuéyuán 169
wúdǎoyǎnyuán 191
wúding 58
wúdingchuāng 58
wúdinghuayuán 84
wúdòuchú 70
wūgāndá 317
wúgōng 295
wúguāngqī 83
wúguāngzè 83, 271
wúguǐdiànchē 196
wúhé 127
wúhémìjū 126
wúhépútāogān 129
wúhèxiāopútāogān 139
wúhuāguǒ 129
wújiāndài 34
wújīndiàn 114
wújīng 124
wújīng 167
wújīnggānlán 125
wújīzhuī dòngwù 295
wújūn 47
wúkèlán 316
wūlāguī 315
wūli 162
wūliáo 25
wūlixué 169
wúmíngzhǐ 15
wúqian 199
wúqū 259
wúshéng diànhuà 99
wúshí 308
wúshù 237
wúshuǐguān 61
wútái 254
wútáicèyì 254
wútángfēnde 145
wúwǎn 309
wúxiàndiàn guǎngbō 179
wúxiàndiàn tiānxiàn 214
wúxiànpǔ 256
wúxiù 34
wūyā 292
wūyán 58
wúyānde 137
wūyè 305
wūyuè 306
wūzéi 121
wúzhàng'àisaimǎ 243
wúzhé 98
wúzhibiékèsītān 318
wúzuī 181
wúzuīshífāng 181
- X
Xguāng 48
Xguāng xīnglǐ jiǎnchájī 212
Xguāngxiàn kànpianqī 45
xi 169
xī 38, 77
xī 12, 289, 312
xià'è 14
xiàbà 14
xiàgǒu 284
xián 258
xián 19, 155, 165, 276
xiànbǐng 158
xiànbǐng kǎomú 69
xiānchūāng 214
xiānduānbù zuàntóu 78
xiàng 272, 291
xiāng 130
xiàng hòu huīgān 233
xiàng...fāngxīang 320
xiāngbāobù 104
xiàngbī 291
xiāngbīnjiǔ 145
xiāngcái 133
xiāngcǎo 132, 133, 134
xiāngcǎo huàyuán 84
xiàngcè 271
xiāngcháng 118, 155, 157
xiāngcūn yīnyuè 259
xiàngguǒ 125
xiàngjī zhōnglèi 270
xiāngjiān huàyuán 84
xiāngjiào 128
xiàngjiào ruǎnguǎn 89
xiāngjiāoxuē 89
xiàngjīhè 271
xiāngkuàng 271
xiàngliàn 36
xiàngliànzhui 36
xiāngliàobāo 132
xiàngmù 247
xiàngpī 163
xiàngpiān 271
xiàngpǐgāo 47
xiàngpítǔzhāng 173
xiàngpǔ 237
xiàngrikuí 184, 297
xiàngrikuízǐ 131
xiàngshàng 320
xiàngshù 296
xiāngshuǐ 41, 105
xiāngsuǒ 157
xiàngxià 320
xiāngxīnlǎo 132
xiāngyān 112
xiāngyóu 134
xiāngzhīcù 135
xiāngzǐlán 132
xiānhuà zhīwù 297
xiànjū 81
xiānnǎilǎo 136
xiānrénzhāng 87
xiānrénzhāngguǒ 128
xiānshēng 23
xiānshìpíng 269
xiānshìqī 172, 176
xiànshù 277
xiànshù 195
- xiántī 214
xiánwǎimádá 215
xiánwéi 127
xiánwéibǎn 79
xiánwèijīng 167
xiányífan 94, 181
xiányuè 280
xiányuèqī 256
xiànzài 304, 320
xiánzhèn 258
xiánzhóu 245, 258, 276, 277
xiào 321
xiào 25
xiàobi 12
xiàobiàn 39
xiàobīngxiāng 101
xiàocānglán 110
xiāocháng 18
xiàochē 196
xiàochuān 44
xiāochuāntíngkǎoqū 217
xiàodào 262
xiàodiàoxiàng 260
xiàodòukǒu 132
xiàodú shījīn 47
xiàodújī 47
xiàoduyè 51
xiàofāngchē 95
xiàofāngdù 95
xiàofāngduiyuán 95, 189
xiàofāngfú 95
xiàofāngshuān 95
xiàofāngtǐ 95
xiàofāngtōngdào 95
xiàofāngzhàn 95
xiàofèi 152
xiàofú 162
xiàogǒu 290
xiàohàibào 290
xiàohào 257
xiàohóngluóbo 124
xiàohuà 122
xiàohuàxìtǒng 19
xiàohuixiāng 132
xiàohuizuān 247
xiàojī 185
xiàojiāshù 290
xiàojiè 23
xiàojiè 299
xiàojiéxiàn 256
xiàojīng 58, 85
xiàojūngǔ 257
xiàolìcàidòu 131
xiàolóngxià 121
xiàolónmótóu 205
xiàomài 130, 184
xiàomāo 290
xiàomí 130
xiàomiànbào 139
xiàoniúròu 118
xiàopǎo 243
xiàoqú 230
xiàoshānyáng 185
xiàoshí 304
xiàoshòubù 175
xiàotíqín 256
xiàotuī 12
xiàotuidǔ 13
- xiāoxiàng 298
xiāoxīng gōnggòngqìchē 197
xiāoxīngqiāo 247
xiāoxīngxing 280
xiāoyā 185
xiāoyányào 109
xiàoyuán 168
xiàoyuán dàngāo 140
xiàoyuán miànbào 143, 155
xiàozhǎng 163
xiāozhǐ 15
xiāozhǐ 185
xiàoshuǐ 118
xiàoshuǐdào 299
xiàotiān 31, 307
xiàowéiyí 314
xiàowù 305
xiàzǎi 177
xiàzhōu 307
xībányà 316
xībēi 53
xībóliyà 313
xībùpiān 255
xíchángxingmiànbào 139
xíchénqī 77, 188
xidàixié 37
xidí 76
xidícao 61, 66
xidíyè 77
xié 34, 37
xiè 162
xiébiān 164
xiédài 37
xiédí 37
xiédìng 114
xiédíng 233
xiéfangjī 16
xiégēn 37
xiējùjià 81
xiéshè 37
xiéxuēbù 104
xièyān 37
xièyào 109
xiēzi 295
xifānlíangguǒ 128
xífāshuǐ 38
xíguā 127
xíguān 77, 144, 154, 167
xīhúlu 124
xījīāshuǐ 41
xìjù 254
xìjùpiān 255
xīlǎ 316
xīlǎnhuà 123
xīlǐ 26
xīlín yǔ 72
xīliú 285
xīmǎlāyǎ shānmài 313
xīn 98
xīn 119, 122, 289, 321
xīn gǔdiǎnzhùyì fēnggē 301
xīn yìshù fēnggē 301
xīnfēng 98, 173
xīng 126
xīng 280
xīngbìng 20
xīngfēn 25
xīngjiāo 20

- xíngjūn chuāng 266
xínglái 71
xínglǐ 100, 198, 213
xínglǐ chuānsòngdài 121
xínglǐcāng 196
xínglǐchē 100
xínglǐjià 204, 209
xínglǐtuīchē 213
xínglǐtuōchē 212
xínglǐxiāng 198
xíngqī 306
xíngqièr 306
xíngqīliú 306
xíngqīrì 306
xíngqīsān 306
xíngqīsì 306
xíngqīwú 306
xíngqīyī 306
xínggrén 129, 151
xínggrénhú 141
xínggrényóu 134
xíngxi 280
xíngxíng 280, 282
xíngyún 280
xíngzhèngqū 315
xíngzuò 281
xínhào 209
xīniú 291
xīnjī gēngsè 44
xīnjiāpō 318
xīnnián 27
xīnshèng'ér 53
xīnshuǐ 175
xīnwén 178
xīnwén bōyīnyuán 179, 191
xīnwén jìzhè 191
xīnwén mèiti 178
xīnxiān 121, 127, 130
xīnxiāng 58, 99
xīnxīlán 319
xīnxípíng 213
xīnxuéguānxìtǒng 19
xīnyòngkǎ 96
xīnyuè 280
xīnzàng 18
xīnzàngbìngkē 49
xióng 291
xiōng 12, 119
xiōngdi 22
xiōnggǔ 17
xiōngjī 16
xiōngkuò 17
xiōngmāo 291
xiōngqí 294
xiōngruǐ 297
xiōngyálì 316
xiōngzhào 35
xiōngzhēn 36
xiōngzhuī 17
xipái 273
xipíxiāogānjú 126
xīrúqì 109
xīrúqì 53
xīsāhàlā 317
xīshì xiànbǐng 143
xīshìjī 83
xīshǒuchí 72
xīshuāi 295
- xisuǒ'èr 240
xītǒng 176
xītóupén 38
xiūjiān 39, 91
xiùkē 47
xiùkòu 36
xiùkǒu 32
xiùlǐ gōngjùxiāng 307
xiùlǐjiān 89
xiùsè 25
xiùxián 254
xiùxián chuídiào 245
xiùxián shàngyī 33
xiūzhī 90
xiūzhífú 256
xiūzhǐjiān 89
xiùzǐ 34
xiwǎnjī 66
xixiāngcōng 133
xixīlǐdào 316
xiyān 112
xiyáng shuānglùqì 272
xiyānqū 152
xiyī 293
xiyī fúwù 101
xiyī gānyījī 76
xiyījī 76
xiyījiān 76
xiyīlán 76
xīzǎo 72
xīzhǐ 296
xīzhuāng 255
xuánbì 95
xuānchuānyè 96
xuānguà huáxiāng 248
xuānguàshì huáxiāngjī 248
xuānguàshì wénjiànjiā 173
xuānlǐ 259
xuānshèng xiàjiàng 248
xuānwúyǎn 288
xuányá 285
xuányǐ 211
xuánzhuǎn 230
xuè 287
xuèbēng 247
xuèdào 246
xuèdàowài 247
xuèhuāsū múzǐ 69
xuèjiā 112
xuèlǐjiū 145
xuēpǐ 67
xuēpíndào 68
xuèshèng 162
xuèshèngshítáng 168
xuèshèngsùshè 168
xuèsōng 296
xuèwèi 169
xuèwèipào 169
xuèxí 162, 163
xuèxí huódòng 162
xuèxiào 162, 299
xuèxiyòngjù 165
xuèyā 44
xuèyājī 45
xuèyú 120
xūhòushuǐ 73
xùjiè 168
xùlǐyà 318
- xūnfēiyú 157
xūnhuán xūnliàn fā 250
xūnhuísài 233
xūnliàn 250
xūnròu 118, 157
xūnyú 143
xūnzhi 159
xūnzhide 118, 121, 143
xùqū 256
xūruò 321
- Y
yā 119, 185
yáchí 50
yáchí hūlǐ 108
yādàn 137
yādào 237
yágāo 72
yágēn 50
yāhuàzhǐ 83
yājiāo 276
yājūnbān 50
yákēyī 50
yālì 55
yǎlǐfá 61
yǎlǐng 250
yǎlǔjī 187
yàmà 184
yàmábù 277
yàmǎijī 314
yàmǎijīchǒujú 126
yàmásūn píngyuán 312
yàměiniyà 318
yán 64, 152
yán 19, 95
yánbì 301
yánbō 68, 167
yáncáo 58
yāncáo 112, 184
yánchū 68, 167
yāncōng 58, 214
yándòng 284
yāndǒu 112
yángcōng 124
yánggāo 185
yángguāng 286
yángguāng míngmèi 286
yánghuái 110
yángjiào miànbào 156
yángjiàodǒu 122
yángjīchǎng 183
yángmáoshān 32
yángmǎotǎn 74
yāngmiào 91
yàngpiàn 271
yàngqǐping 239
yángqún 183
yángshuǐ 52
yángshuǐ chuāncǐ zhēnduàn 52
yángtái 59
yángtáo 128
yāngū 112
yángwēi 20
yāngwòqīzuò 250
yāngyǒng 239
yāngyú 120
yāngyúchǎng 183
yāngzhūchǎng 183
- yānhé 112
yānhóu 19
yānhuīgāng 150
yānjiān 51
yānjiāng 283
yānjiāngchí 283
yānjīng 51
yānjīng 14, 51
yānjīng hé 51
yānjiū 169
yānjiūshèng jiēduàn 169
yānkē 49
yánkǒu 300
yānlèi 51
yānlǎo 274
yànmài 130
yánsè 274
yánshí 284, 288
yánshíyuán 84
yànwú 321
yànwú bàojīngqì 95
yānxiānyè 40
yānxuè 48
yānyíng 40
yānyuán 179, 191
yánzhe... 320
yānzhide 118
yānjiān 292
yānzi 159
yánzide 121, 129, 137, 143
yānzui 112
yào 109
yāo 12
yàocáo 55, 86
yàodài 32, 35, 36, 236
yāodàikǒu 36
yàodiàn 108
yāodībù 13
yāogān 150
yàogāo 47
yàogōng zhuànpán 275
yàogōu 245
yàogūn yīnyuèhù 258
yàoguò 129, 151
yàojīshì 108, 189
yàokòngqì 269
yàopiàn 109
yāoròu 121
yāoshāng 46
yàoshi 59, 207
yàowú zhǐliáo 109
yàoyú 120, 294
yàoyúchì 120
yāozhuī 17
yápiàn 50
yáshuā 72
yāsuanqì 68
yāsuide 132
yátǒng 50
yáxiàn 50, 72
yáxuè 120
yáyí 50, 189
yáyín 50
yàzhōu 318
yázuàn 50
yè 122, 296
yēcān 263
yēcānchāngyī 266
- yècū 110
yéfēngxīnzǐ 297
yégēng 297
yēji 119
yémén 318
yèshèng dòngwùyuán 262
yētí fēngmǐ 134
yētí liángqì 311
yèwèi 119
yèwèiròu 118
yèwō 13
yèyán 288
yèyingchē 266
yèyínglú 267
yèzǎo 129
yèzi 129
yì 308
yì jīngguò bāshìxiāodúde 137
yì kèzhōng 304
yì xiǎobēi 151
yìbái 308
yìbàiwàn 309
yìbèi 121, 295
yìbèi 64, 210
yìbiāopán 201
yìcéng 104
yìchéng 174
yìchú 70
yìchénghéxiàng quánzìdòng
xiàngjī 270
yìcìxíng niàobù 30
yìcìxíng tìxūdāo 73
yìcìxíng xiàngjī 270
yìcìxíngde 109
yìdǎlì 316
yìdǎlì miànshí 158
yìdǎlì xūnhuòtuǐ 143
yìdǎlì xiāngcháng 142
yìdǎn nǎilào 142
yìdàosù 109
yìdiǎn'er 320
yìdòng bǐngchuáng 48
yìdòng diànhuà 99
yìfèn 64
yìfújià 76
yìfúpái 273
yìgān rúdòng 233
yìhòu 304, 320
yìjià 70
yìlākè 318
yìlǎng 318
yìlǐng 32
yìliúguān 61
yìmín 26
yìn 289
yìn yóu jiāntóude xīnzhǐ 173
yīnchǎn 53
yīnchún 20
yīndào 20
yīndàogémó 21
yīndì 20
yīndì zhīwù 87
yīndù 318
yīndù cǎoyào liǎofá 55
yīndù yáng 313
yīndùnxīyà 319
yīndùshìmiànbào 139

- yinfú 256
 yíng 273
 yíng 124, 129, 321
 yíng 292
 yíng'ér 23, 30
 yíng'ér bèi 75
 yíng'ér biānpén 74
 yíng'ér chéng 53
 yíng'ér chuāng 74
 yíng'ér diàodài 75
 yíng'ér hūlǐ 74
 yíng'ér jiān 104
 yíng'ér jiānshìqì 75
 yíng'ér liánjiāokǒu 30
 yíng'ér shǒutào 30
 yíng'ér shuǐlǎn 74
 yíng'ér shuǐyī 30
 yíng'ér xié 30
 yíng'ér yīwùdài 75
 yíng'ér yóngpīn 107
 yíng'ér yùpén 74
 yíngāo 256
 yíngbì 97
 yíngcǎo 297
 yíngchǐ 310
 yíngcùn 310
 yíngdì guānlíchù 266
 yíngdídēng 267
 yíngguó 316
 yíngguóguān 257
 yíngguó 266
 yíngjiā 273
 yíngjiàn 176
 yíngjide 129
 yínglǐ 310
 yíngmiānbāoquān 139
 yíngmó wài mázui 52
 yíngmù 79
 yíngnǎilào 136
 yíngpán 176
 yíngshì gǎnlǎnqiú 221
 yíngshì gǎnlǎnqiú qiūchǎng 221
 yíngshì jièmojiàng 135
 yíngshì zāocān 157
 yíngsù 297
 yíngsùfāng 181
 yíngsùzǐ 138
 yíngtáng 113
 yíngtáo 126
 yíngtáofānqié 124
 yíngwù 293
 yíngyǎngpīn 55
 yíngyòng chéngxù 176
 yíngzhīhé 311
 yíngzhilùjiān 194
 yíngzuidòu 131
 yínháng 96
 yínháng jīnglǐ 96
 yínháng shǒuxùfèi 96
 yínháng zhuānzhàng 96
 yínhángkǎ 96
 yínhuòwù 266
 yiniánshēng (zhīwù) 86
 yīnjiē 256
 yīnjīng 21
 yīnliàng 179, 269
 yīnliào 107, 144, 156
 yīnmù 255
 yīnnáng 21
 yīnpái 235
 yínqíng 202, 204, 210
 yínqínggài 198
 yīnshǐ 75
 yīnshuā 275
 yíntái 173
 yíntǐ xiàngshàng 250
 yīnxiāng 176, 268
 yīnxiàngdiàn 115
 yīnxiāngjià 268
 yīnxíng yǎnjīng 51
 yīnxíng yǎnjīng hé 51
 yīnyuē 162
 yīnyuē fēnggé 259
 yīnyuēhuì 255, 258
 yīnyuējiā 191
 yīnyuējù 255
 yīnyuēxiéyuán 169
 yīnzuoyuán 255
 yīpēngtiāode 130
 yīqiān 309
 yīshìliè 318
 yīsháoliàng 149
 yīshēng 45, 189
 yīshìníngsuǒ kāfēi 148
 yīshù 162
 yīshù tīcāo 235
 yīshùguān 261
 yīshùpīndiàn 115
 yīshùshì 169
 yīshùnhuái 98
 yīwàn 309
 yīwùlǎn 76
 yīxié 320
 yīxué 169
 yīyōngdēng 50
 yīyōngdiàodài 46
 yīyōngjiābān 47
 yīyōngqián 167
 yīyuàn 48
 yīyuē 306
 yīzàng 18
 yīzhí 91
 yīzhí 320
 yīzhíchǎn 89
 yīzǐ 64
 yīzituí 64
 yòng shāzhǐ dǎmó 82
 yòng yáxiàn jīchí 50
 yōngdào 238
 yōnggǎn zhīchēng 91
 yōngjīn 97
 yōngjù 238
 yōngkù 238
 yōngmào 238
 yōngyī 238
 yōngzǐ 239
 yóu 134, 142, 199
 yòu 260
 yóucài 123
 yóucàizǐ 184
 yòucèjiāshǐ 201
 yóuchuó 98
 yóudài 98, 190
 yóudiyuán 98, 190
 yóuér 30
 yòuguāngzé 83, 271
 yòuguǎndiànché 196, 208
 yòuhéshuǐguò 126
 yóuhuà yǎnliào 274
 yǒuji fèiwù 61
 yǒujià zhèngquān zùhé 97
 yǒujide 91, 118, 122
 yóujú 98
 yóujú zhīyuán 98
 yóukè 260
 yóulǎn shèngdì 50
 yóulǎnché 197
 yóulǎnxīn 261
 yóulèchǎng 263
 yóulèyuán 262
 yóuliàngbiào 201
 yōulǚ 25
 yóulún 215
 yóumén 200, 204
 yómò 275
 yóupiào 98, 112
 yóuqí 83
 yóuqǐ gǔntǒng 83
 yóuqipán 83
 yóuqǐtǒng 83
 yóuqù 321
 yóushēng zhínénglǐde 20
 yóusùdiànxīn 140, 149
 yóutàijiào huítáng 300
 yóutáo 126
 yóuting 215
 yóutǒng 99
 yóuwǎiyè 229
 yóuxi 75, 272, 273
 yóuxi wéilán 75
 yóuxiàn diànshì 269
 yóuxiāng 203
 yóuxiào qiàxiàn 109
 yóuxijiemù 178
 yóuxing 39, 41
 yóuxíng 27
 yóuyǎng yùndòng 250
 yóuyǒng 238
 yóuyǒng xuǎnshǒu 238
 yóuyǒngchí 101, 238, 250
 yóuyǒngjīng 238
 yóuyǒngquān 265
 yóuyǒngyī 265
 yóuyú 121, 295
 yóuzhá 159
 yóuzhèngbiānmǎ 98
 yòuzhǐ 50
 yóuzǐ 143
 yóuzǐ 98
 yóuzui 181
 yú 107, 155, 120
 yú 287
 yú'èrdài 291
 yuǎndài 233
 yuándīng 300
 yuándīng 188
 yuándīngpào 250
 yuángōng 175
 yuánguī 165
 yuánhào 257
 yuánjù 78
 yuánli 130
 yuánlǐng 33
 yuànshì 51
 yuānwēi 110
 yuánxīn 164
 yuánxíng 164
 yuānyángkèlún 214
 yuānyī 90
 yuānyī gōngjù 88
 yuānyī shèjì 91
 yuānyī shǒutào 89
 yuānyī yòngpīndiàn 115
 yuánzhōu 164
 yuánzhuitǐ 164
 yuánzhūtǐ 164
 yuǎnzú 263
 yúchābūyù 245
 yúchuán 217
 yùdīng 168
 yuè 306
 yuèchí 254
 yuèdàn 318
 yuèdùdēng 210
 yuèduì 254, 256
 yuèfú 23
 yuègūiyè 133
 yuèguò 320
 yuèhuì 175
 yuèjīng 20
 yuèlǎnshì 168
 yuè mù 23
 yuè nán 318
 yuèpǔ 255, 256
 yuèqǐ 256, 258
 yuèqiú 280
 yuèwèi 223
 yuèyè huàxuè 247
 yuèyémótuō 205
 yuèzhàng' àisài 243
 yuèzhàngshí 288
 yúfán 188
 yúgān 244
 yúgāng 217
 yúgāng 72
 yúgōu 244
 yúhángyuán 281
 yújia 54
 yújiaxué 286
 yújīn 73
 yújīng 181
 yújīnxiāng 111
 yúlè 294
 yúlín 285
 yúlǒu 245
 yúmáo 293
 yúmáoqiú 231
 yúmì 130, 184
 yúmíapán 89
 yúmímímiānbào 139
 yúmín 189
 yúmíyóu 135
 yún 287
 yúnbó 128
 yúnychào 109
 yúndào 25
 yúndòng xiōngzhào 35
 yúndòngchǎng 168, 234
 yúndòngfú 31
 yúndòngkù 33
 yúndòngshān 33
 yúndòngxié 31, 37, 250
 yùndòngyuán 191
 yùndǒu 76
 yūnī 85
 yúnmù 289
 yúnqíú 227
 yùntàng 76
 yùnyībān 76
 yùpáo 73
 yúpian 121
 yúróngbèi 71
 yúshāndǒu 297
 yúshāng 46
 yúshí 288
 yúshì 72, 266
 yúshì fānghuádian 72
 yúshù 296
 yúshuā 198
 yútou 124
 yúwǎng 217
 yúxiàn 244
 yúxiàn 162
 yúyī 31, 32, 245, 267
 yúyigǎnlán 123
 yúyīn xūnxī 99
 yúyīngshì 74
 yúyīngxiāng 53
 yúyuè 45
 yúyuèjié 27
 yúzhōu 280
 yúzhòukōngjiān 280
 Z
 zǎbàntāngguó 113
 zǎcǎo 86
 zài 320
 zài...duìmiàn 320
 zài...fùjìn 320
 zài...hòumiàn 320
 zài...lǐ 320
 zài...lǐmiàn 320
 zài...pángbiān 320
 zài...qiánmiàn 320
 zài...shàng 320
 zài...shàngfāng 320
 zài...shàngmiàn 320
 zài...wài 320
 zài...wàimiàn 320
 zài...xiàfāng 320
 zài...xiàmiàn 320
 zài...zhìhòu 320
 zài...zhìjiān 320
 zài...zhìqián 320
 zài...zhìshàng 320
 zài...zhōuwéi 320
 zāibōpiàn 167
 zāiláiyíci 255
 zāipéi 91
 zāiwútái 167
 zàixiàn 177
 zàizhōngqìchē 194
 zànbìyà 317
 zāng 321
 zànghónghuā 132
 zànglǐ 26
 zāngyiwù 76
 zàntíng 220, 269
 zǎo 305, 320

- zāocān 64, 156
 zāocān màipiàn 107
 zāocānpán 101
 zāocānzhuō 156
 zāochānde 52
 zāochén 305
 záozi 81, 275
 zázhi 107, 112, 168
 zhàdè 317
 zhài 321
 zhāichú kúhuà 91
 zhāiyuè 27
 zhājī 155
 zhāmèng 295
 zhāndòuji 211
 zhàng'ài 243
 zhàng'aisai 243
 zhàngdān 152
 zhàngfú 22
 zhànggū 17
 zhànghào 96
 zhàngláng 295
 zhàngpéng 267
 zhàngpénggān 266
 zhàngshàng diànmǎo 175
 zhāngyú 121, 295
 zhānjiàn 215
 zhānlǎn 261
 zhānpīn 261
 zhànqiáo 217
 zhàntái 208
 zhàntáihào 208
 zhànxiàn 99
 zhào 291, 293
 zhàomíng 178
 zhàomíngdàn 240
 zhàopái 104
 zhàoshān 38
 zhāoshèngbān 168
 zhàoxiàng 271
 zhàoxiàng qicáidiàn 115
 zhàoxiàngjī 260
 zhàozé 285
 zhàshùpiàn 151
 zhèbèi jiāodài 83
 zhédíeshì yíng'érché 75
 zhei 273
 zhěilǐ 320
 zhèn 276
 zhēnbǎn 276
 zhēndiàn 276
 zhèndòng 283
 zhènduàn 45
 zhèng 165
 zhèng 67
 zhèngcān 158
 zhèngcān yòngpán 165
 zhèngcūmàifēn 130
 zhèngfāngxíng 164
 zhènggū liáofā 54
 zhèngjī 167
 zhèngjiù 181
 zhènglǐ 130
 zhènglǐ chuāngpù 71
 zhèngqíjīché 208
 zhèngquàn 97
 zhèngquàn jiāoyisùo 97
 zhèngquè 321
 zhèngrén 180
 zhèngshǒu 231
 zhèngtíng qiánpái zuòwèi 254
 zhèngwú 305
 zhèngxíngwàikè 49
 zhèngzhī 91
 zhèngzhixué 169
 zhèngzhuāng 34
 zhēnjiào 277
 zhēnjiào xuānzéqì 276
 zhènjīng 25
 zhènjīngjī 109
 zhēnjiù 55
 zhēnlíoshì 45
 zhēnrényóu 134
 zhěnsuǒ 48
 zhěntàn 94
 zhěntào 71
 zhěntóu 70
 zhěntóu 109
 zhēnxiānguāng 276
 zhēnyèshù 86
 zhènyù 286
 zhènzhū xiàngliàn 36
 zhēnzi 129
 zhēshāng 46
 zhétí 82
 zhèxiágāo 40
 zhéxué 169
 zhēyángmào 30, 265
 zhēyángpéng 75, 148
 zhēyángsān 148, 264
 zhēzhēn 295
 zhézhì 275
 zhi 14, 293
 zhibǎn 275
 zhibǎnzhixíng 275
 zhibi 97
 zhibiān 277
 zhibīngshì 67
 zhibō 178
 zhibù 277
 zhibùjī 277
 zhícháng 21
 zhíchēnggān 89, 91
 zhíchí 165
 zhídài 207
 zhídào... 320
 zhídòngyè róngqì 202
 zhífá 39
 zhífú 94, 189
 zhígú 17
 zhíguānjié 15
 zhiháng 260
 zhíhé 172, 311
 zhihui 256
 zhihuibàng 256
 zhihuità 215
 zhihuitài 256
 zhijia 15
 zhijia 88, 205, 207, 267
 zhijia hùli 41
 zhijiacuò 41
 zhijiaodào 41
 zhijiajiàn 41
 zhijiyayóu 41
 zhijie jieji 96
 zhijièwàiqiú 223, 226
 zhijin 108
 zhijing 164
 zhijinhé 70
 zhikéyào 108
 zhili 315
 zhiliáoshì 55
 zhiliudiàn 60
 zhīmacài 123
 zhīmāyóu 134
 zhīmāzǐ 131
 zhīmíndì 315
 zhīnánzhēn 240, 312
 zhǐpái 273
 zhipiānrén 254
 zhipiào 96
 zhipiào cúngēn 96
 zhipiàobù 96
 zhìqiú 227
 zhíshēng fěiji 211
 zhītóngyào 47, 109
 zhítuyuán 191
 zhíwén 94
 zhíwù 296
 zhíwù rǒushùnjī 76
 zhíwùyóu 135
 zhixī 47
 zhíxing bīnggān 141
 zhíyá ànmó 54
 zhíyá liáofā 55
 zhíyàng 276
 zhíyè 127
 zhíyèr 190
 zhíyèyī 188
 zhiyin 260
 zhízhāngpéng 266
 zhízhū 295
 zhízuò 187
 zhízuò miànbào 138
 zhòng 321
 zhōngbiāo 62, 304
 zhōngbō 179
 zhōngchǎng 224
 zhōngdiǎn xiàn 234
 zhōngdú 46
 zhōngfēi gònghéguó 317
 zhōngfēng 44
 zhōnggēngjī 182
 zhōngguó 318
 zhōngguówùshù 236
 zhōngjiāncéng 286
 zhōngjīnmiànfēn 139
 zhōngjīnshùiyuógǔn 259
 zhōnglǐ 280
 zhōngliàng xùnlìàn 250
 zhōngliúkē 49
 zhōngpǔ lùmiàn 187
 zhōngquān 222, 224, 226
 zhōngtiān 256
 zhōngwàiyì 228
 zhōngxiàn 226
 zhōngxíng 39
 zhōngyāngchédào 194
 zhōngyāngchǔlǐqì 176
 zhōngyāngfēnchédài 194
 zhōngzhī 183
 zhōngzhī 15
 zhòngzhiyuán 183
 zhōngzi 88, 122, 130, 131
 zhǒu 13
 zhǒuméi 25
 zhǒumó 306
 zhǒuwén 15
 zhǒuyuè 305
 zhù 300
 zhù 185
 zhuan 187
 zhuān yòngyùshì 100
 zhuānbidào 163
 zhuāng'ěr 245
 zhuāngjia 183
 zhuāngrú 76
 zhuāngshì 141
 zhuāngshijìxiàn 63
 zhuāngshipèiliào 155
 zhuāngshiyìshù fēnggè 301
 zhuāngxìàn 159
 zhuāngxiū 82
 zhuānkē yìshēng 49
 zhuānshēn 238
 zhuānsùbiào 201
 zhuānxiàngdēng 198, 204
 zhuānyì 172
 zhuānzhēn 49
 zhuāwò 237
 zhūbào zhizuò 275
 zhūbàojiàng 188
 zhūcài 153
 zhūcáipàn 222
 zhūchǎn 53
 zhūchàng 258
 zhūchǎnshì 53
 zhūchí 174
 zhūchú 152
 zhūchú 152
 zhūding méiliáng 301
 zhūfān 240
 zhūfèi 67
 zhūguǎn 174
 zhuixínggélidūn 187
 zhújiàn 236
 zhújìdàn 137, 157
 zhújīng 297
 zhújuàn 185
 zhúlǐ 24
 zhúlùrukǒu 194
 zhǔnquèdì 320
 zhǔnshí 305
 zhuōbù 64
 zhuólù 211
 zhuomiàn 177
 zhuōmiànbèijīng 177
 zhuómuniào 292
 zhūozǐ 148
 zhǔquán guójia 315
 zhūrén 64
 zhūròu 118
 zhùshè 48
 zhùshèqì 109, 167
 zhùshuǐ 67
 zhùshuixiāng 61
 zhúsūn 122
 zhùtí gōngyuán 262
 zhùtūiqì 281
 zhūxuè xiāngcháng 157
 zhúzi 86
 zǐ 128
 zidiān 163
 zidòng 200
 zidòng fúti 104
 zidòng mén 196
 zidòng tiáowénqì 61
 zidòng tīshìjī 179
 zidòngxī chēzhàn 199
 zifāfēn 139
 zigōng 52
 zigōng 52
 zigōng 20
 zigōngjīng 20, 52
 zigōngtuō 21
 zihào 25
 zihuāmùxu 184
 zijie 176
 zilái shuǐ 144
 ziluólan 110
 zimèi 22
 zipái 272
 ziránkèxué 162
 ziránliáofā 55
 zisè 274
 zishuijīng 288
 zití 177
 zīwàixiàn 286
 zīwàixiàn yùchuáng 41
 ziwèi 237
 zixin 25
 zixíngché 206
 zixíngché zhìjià 207
 zixíngchédào 206
 ziyóutícāo 235
 ziyóuyǒng 239
 zizhucān 152
 zizhuzāocān 156
 zōngbù 175
 zōnggōngsī 175
 zōnghèshè pífú 41
 zōnghuì sānmíngzhì 155
 zōngjīnglǐ 175
 zōnglú 86
 zōnglǔshù 296
 zōnglǔxīn 122
 zōngmáo 242, 291
 zōngshēn 165
 zóuláng 168, 210
 zóumíngqǔ 256
 zóuqì 273
 zuànjìatǒu 78
 zuànkǒng 79
 zuànkǒngqì 80
 zuànshí 288
 zuàntōu 80
 zūchēchù 213
 zúdǎng 227
 zúdi fānshè liáofā 54
 zúfú 22
 zúfú 23
 zúgōng 15
 zúhéchōuti 172
 zú 14
 zuifān 181
 zuìhòu 320
 zuixíng 94
 zúmù 22
 zūnyú 120
 zuō 260

zuǒcèjiàshǐ 201
zuògǎn 206
zuótiān 306, 320
zuǒwàiyè 228
zuòwèi 64, 209, 210, 254
zuòwèi'ānpái 254
zuòwén 163
zuòyè 163
zuòyí tóuzhēn 200
zúqú 222
zúqú qiúyī 31, 222
zúqú qiúyuán 222
zúqúchǎng 222
zūyòng 58

英文索引 yīngwén suǒyǐn • English index

- A**
 à la carte 152
 abdomen 12
 abdominals 16
 above 320
 abseiling 248
 acacia 110
 accelerator 200
 access road 216
 accessories 36, 38
 accident 46
 account number 96
 accountant 97, 190
 accounts department 175
 accused 180
 ace 230, 273
 Achilles tendon 16
 acorn squash 125
 acquaintance 24
 acquitted 181
 across 320
 acrylic paints 274
 actions 237, 229, 227, 233, 183
 activities 263, 245, 162, 77
 actor 254, 191
 actors 179
 actress 254
 acupressure 55
 acupuncture 55
 Adam's apple 19
 add v 165
 address 98
 adhesive tape 47
 adjustable spanner 80
 admissions 168
 admitted 48
 aduki beans 131
 adult 23
 advantage 230
 adventure 255
 advertisement 269
 aerate v 91
 aerobics 251
 Afghanistan 318
 Africa 317
 after 320
 afternoon 305
 aftershave 73
 aftersun 108
 agate 289
 agenda 174
 aikido 236
 aileron 210
 air bag 201
 air conditioning 200
 air cylinder 239
 air filter 202, 204
 air letter 98
 air mattress 267
 air stewardess 190
 air supply 199
 air vent 210
 aircraft 210
 aircraft carrier 215
 airliner 210, 212
 airport 212
 aisle 106, 168, 210, 254
 alarm clock 70
 Alaska 314
 Albania 316
 alcoholic drinks 145
 alfalfa 184
 Algeria 317
 allergy 44
 alley 298
 alligator 293
 allspice 132
 almond 129
 almond oil 134
 almonds 151
 along 320
 alpine 87
 alpine skiing 247
 alternating current 60
 alternative therapy 54
 alternator 203
 altitude 211
 aluminium 289
 Amazonia 312
 ambulance 94
 American football 220
 amethyst 288
 amniocentesis 52
 amniotic fluid 52
 amount 96
 amp 60
 amphibians 294
 amplifier 268
 anaesthetist 48
 anchor 214, 240
 Andes 312
 Andorra 316
 angle 164
 angler 244
 Angola 317
 angry 25
 animals 292, 294
 animated film 255
 ankle 13, 15
 ankle-length 34
 anniversary 26
 annual 86, 307
 anorak 31, 33
 answer 163
 answer v 99, 163
 answering machine 99
 ant 295
 antenna 52
 antena 295
 antifreeze 199, 203
 Antigua and Barbuda 314
 anti-inflammatory 109
 antique shop 114
 antiseptic 47
 antiseptic wipe 47
 anti-wrinkle 41
 antler 291
 apartment block 298
 apéritif 153
 aperture dial 270
 apex 165
 appeal 181
 appearance 30
 appendix 18
 applaud v 255
 apple 126
 apple corer 68
 apple juice 149
 appliances 66
 application 176
 appointment 45, 175
 apricot 126
 April 306
 apron 30, 50, 69, 212
 APS camera 270
 aquamarine 288
 Arabian Sea 313
 arable farm 183
 arc 164
 arch 15, 85, 301
 archery 249
 architect 190
 architecture 300
 architrave 301
 Arctic circle 283
 Arctic Ocean 312
 area 165, 310
 areas 299
 arena 243
 Argentina 315
 arithmetic 165
 arm 13
 armband 238
 armchair 63
 Armenia 318
 armpit 13
 armrest 200, 210
 aromatherapy 55
 around 320
 arrangements 111
 arrest 94
 arrivals 213
 arrow 249
 art 162
 art college 169
 art deco 301
 art gallery 261
 art nouveau 301
 art shop 115
 artery 19
 artichoke 124
 artist 274
 arts and crafts 274, 276
 ash 283
 ashtray 150
 Asia 318
 assault 94
 assistant 24
 assisted delivery 53
 asteroid 280
 asthma 44
 astigmatism 51
 astronaut 281
 astronomy 281
 asymmetric bars 235
 at 320
 athlete 234
 athletics 234
 Atlantic Ocean 312
 atmosphere 282, 286
 atrium 104
 attachment 177
 attack 220
 attack zone 224
 attend v 174
 attic 58
 attractions 261
 aubergine 125
 auburn 39
 audience 254
 August 306
 aunt 22
 aurora 286
 Australasia 319
 Australia 319
 Austria 316
 autocue 179
 automatic 200
 automatic door 196
 autumn 31, 307
 areas 299
 avenue 299
 avocado 128
 awning 148
 axe 95
 axle 205
 ayurveda 55
 Azerbaijan 318
B
 baby 23, 30
 baby bath 74
 baby care 74
 baby changing facilities 104
 baby monitor 75
 baby products 107
 baby sling 75
 babygro 30
 back 13
 back brush 73
 back seat 200
 backboard 226
 backdrop 254
 backgammon 272
 backhand 231
 backpack 31, 37, 267
 backstroke 239
 backswing 233
 bacon 118, 157
 bad 321
 badge 94
 badminton 231
 bag 311
 bagel 139
 baggage reclaim 213
 baggage trailer 212
 bags 37
 baguette 138
 Bahamas 314
 bail 181
 bait 244
 bait v 245
 bake v 67, 138
 baked 159
 baker 139
 baker's 114
 bakery 107, 138
 baking 69
 baking tray 69
 balance wheel 276
 balcony 59, 254
 bald 39
 bale 184
 Balearic Islands 316
 ball 15, 75, 221, 224, 226, 228, 230
 ballboy 231
 ballet 255
 balsamic vinegar 135
 Baltic Sea 313
 bamboo 86, 122
 banana 128
 bandage 47
 Bangladesh 318
 banister 59
 bank 96, 284
 bank charge 96
 bank manager 96
 bank transfer 96
 bap 139
 bar 150, 152, 250, 256, 311
 bar code 106
 bar counter 150
 bar mitzvah 26
 bar snacks 151
 bar stool 150
 barb 244
 Barbados 314
 barbecue 267
 barber 39, 188
 bark 296
 barley 130, 184
 barman 191
 barn 182
 baroque 301
 bars 74
 bartender 150
 basalt 288
 base 164, 229
 base station 99
 baseball 228
 baseline 230
 baseman 228
 basement 58

- basil 133
 basin 50
 basket 106, 207, 226
 basket of fruit 126
 basketball 226
 basketball player 226
 basque 35
 bass clarinet 257
 bass clef 256
 bass guitar 258
 bass guitarist 258
 bassoon 257
 bat 225, 228, 231, 290
 bat v 225, 229
 bath mat 72
 bath towel 73
 bathrobe 73
 bathroom 72
 bathtub 72
 baton 235, 256
 batsman 225
 batter 228
 batteries 260
 battery 167, 202
 battery pack 78
 battleship 215
 bay leaf 133
 bayonet fitting 60
 be born v 26
 beach 264
 beach bag 264
 beach ball 265
 beach hut 264
 beach towel 265
 beach umbrella 264
 beaker 167
 beam 186, 235
 bean sprout 122
 beans 131, 144
 bear 291
 beat 259
 beauty 40, 105
 beauty treatments 41
 bed 70
 bed and breakfast 101
 bed linen 71
 bedding 74
 bedroom 70
 bedside lamp 70
 bedside table 70
 bedspread 70
 bee 295
 beech 296
 beef 118
 beer 145, 151
 beer tap 150
 beetle 295
 beetroot 125
 before 320
 beginning 321
 behind 320
 Belarus 316
 Belgium 316
 Belize 314
 bell 197
 below 320
 belt 32, 36, 236
 bench 250, 262
 Benin 317
 berry 296
 beside 320
 bet 273
 between 320
 beyond 320
 Bhutan 318
 biathlon 247
 bib 30
 bicep curl 251
 biceps 16
 bicycle 206
 bidet 72
 biennial 86
 bifocal 51
 big toe 15
 bike rack 207
 bikini 264
 bill 152, 293
 binoculars 281
 biology 162
 biplane 211
 birch 296
 bird watching 263
 birds 292
 birth 52
 birth weight 53
 birth certificate 26
 birthday 27
 birthday cake 141
 birthday candles 141
 birthday party 27
 biscuit 113
 biscuits 141
 bishop 272
 bit 242
 bit brace 78
 bite 46
 bite v 245
 bitter 124, 145
 black 39, 272, 274
 black belt 237
 black coffee 148
 black hole 280
 black olive 143
 black pudding 157
 Black Sea 313
 black tea 149
 blackberry 127
 blackboard 162
 blackcurrant 127
 black-eyed beans 31
 bladder 20
 blade 60, 66, 78, 89
 blanket 71, 74
 blazer 33
 bleach 77
 blender 66
 blister 46
 block 237
 block v 227
 block of flats 59
 blonde 39
 blood pressure 44
 blood pressure gauge 45
 blood test 48
 blouse 34
 blow dry v 38
 blow out v 141
 blowhole 290
 blue 274
 blue cheese 136
 bluebells 297
 blueberry 127
 blues 259
 blusher 40
 board 241
 board v 217
 board games 272
 boarding pass 213
 bob 39
 bobbin 276
 bobsleigh 247
 body 12
 body lotion 73
 body systems 19
 bodywork 202
 boil v 67
 boiled egg 137, 157
 boiled sweets 113
 boiler 61
 Bolivia 315
 bollard 214, 298
 bolt 59
 bomber 211
 bone 17, 119, 121
 bone meal 88
 boned 121
 bongos 257
 bonnet 198
 book 168
 book a flight v 212
 book shop 115
 bookshelf 63, 168
 boom 95, 240
 booster 281
 boot 198, 220, 223
 booties 30
 bored 25
 borrow v 168
 Bosnia and Herzegovina 316
 Botswana 317
 bottle 61, 75, 135, 311
 bottle opener 68, 150
 bottled foods 134
 bottled water 144
 bottom tier 141
 bounce v 227
 boundary line 225
 bouquet 35, 111
 bouquet garni 132
 bout 237
 boutique 115
 bow 240, 249
 bow tie 36
 bowl 61, 65, 112
 bowl v 225
 bowler 225
 bowling 249
 bowling ball 249
 box 254
 box file 173
 box of chocolates 113
 box of tissues 70
 box office 255
 boxer shorts 33
 boxercise 251
 boxing 236
 boxing gloves 237
 boxing ring 237
 boy 23
 boyfriend 24
 bra 35
 brace 50
 bracelet 36
 brain 19
 brake 200, 204, 206
 brake v 207
 brake block 207
 brake fluid reservoir 202
 brake lever 207
 brake pedal 205
 bran 130
 branch 175, 296
 brandy 145
 brass 256
 Brazil 315
 brazil nut 129
 bread 157
 bread knife 68
 bread roll 143
 breadcrumbs 139
 breadfruit 124
 breads 138
 break a record v 234
 break waters v 52
 breakdown 203
 breakfast 64, 156
 breakfast buffet 156
 breakfast cereals 107
 breakfast table 156
 breakfast tray 101
 breast 12, 119
 breast bone 17
 breast pump 53
 breastfeed v 53
 breaststroke 239
 breathing 47
 breech 52
 brick 187
 bridge 15, 214, 258, 273, 300
 bridle 242
 bridle path 263
 brie 142
 briefcase 37
 briefs 33, 35
 brioche 157
 broad bean 122
 broad beans 131
 broadcast 179
 broadcast v 178
 broccoli 123
 brochure 175
 brogue 37
 bronze 235
 brooch 36
 broom 77
 broth 158
 brother 22
 brother-in-law 23
 browband 242
 brown 274
 brown bread 139, 149
 brown flour 138
 brown lentils 131
 brown rice 130
 browse v 177
 browser 177
 bruise 46
 Brunei 319
 brunette 39
 brush 38, 40, 77, 83, 274
 brush v 38, 50
 brussel sprout 122
 bubble bath 73
 bucket 77, 82, 265
 buckle 36
 bud 111, 297
 buffet 152
 buggy 232
 build v 186
 builder 186, 188
 building site 186
 buildings 299
 built-in wardrobe 71
 bulb 86
 Bulgaria 316
 bull 185
 bulldog clip 173
 bull-nose pliers 80
 bulls-eye 273
 bumper 74, 198
 bun 39, 140, 155
 bunch 111
 bungalow 58
 bungee jumping 248
 bunker 232
 bunsen burner 166
 buoy 217
 bureau de change 97
 burger 154
 burger bar 154
 burger meal 154
 burglar alarm 58
 burglary 94
 Burkina Faso 317
 Burma (Myanmar) 318
 burn 46
 burner 67
 Burundi 317
 bus 196
 bus driver 190
 bus shelter 197
 bus station 197
 bus stop 197, 299
 bus ticket 197
 buses 196
 business 175
 business class 211
 business deal 175
 business lunch 175
 business partner 24
 business suit 32
 business trip 175
 businessman 175
 businesswoman 175
 butcher 118, 188
 butcher's 114
 butter 137, 156
 butter beans 131
 buttercup 297
 butterfly 239, 295

- buttermilk 137
 butternut squash 125
 buttock 13, 16
 button 32
 buttonhole 32
 buttress 301
 by 320
 by airmail 98
 bytes 176
- C**
 cab 95
 cabbage 123
 cabin 210, 214
 Cabinda 317
 cabinet 66
 cable 79, 207
 cable car 246
 cable television 269
 cactus 87
 caddy 233
 caesarean section 52
 café 148, 262
 cafetière 65
 cake shop 114
 cake tin 69
 cakes 140
 calcite 289
 calcium 109
 calculator 165
 calendar 306
 calf 13, 16, 185
 call button 48
 calyx 297
 cam belt 203
 Cambodia 318
 camcorder 260, 269
 camel 291
 camembert 142
 camera 178, 260, 270
 camera case 271
 camera crane 178
 camera shop 115
 cameraman 178
 Cameroon 317
 Camisole 35
 camomile tea 149
 camp v 266
 camp bed 266
 campari 145
 camper van 266
 campfire 266
 camping 266
 camping stove 267
 campsite 266
 campus 168
 can 145, 311
 can opener 68
 Canada 314
 canary 292
 candied fruit 129
 candle 63
 cane 91
 canes 89
 canine 50
 canned drink 154
 canoe 214
 canoeing 241
- canter 243
 canvas 274
 cap 21, 36, 238
 capacity 311
 cape gooseberry 128
 capers 143
 capital 315
 capeira 237
 capsiz v 241
 capsule 109
 captain 214
 capuccino 148
 car 198, 200
 car accident 203
 car hire 213
 car park 298
 car stereo 201
 car wash 198
 caramel 113
 caravan 266
 caraway 131
 caesarean 27
 card 27
 card phone 99
 card slot 97
 cardamom 132
 cardboard 275
 cardigan 32
 cardiology 49
 cardiovascular 19
 cards 273
 cargo 216
 Caribbean Sea 312
 carnation 110
 carnival 27
 carousel 212
 carpenter 188
 carpentry bits 80
 carpet 71
 carriage 208
 carriage race 243
 carrier 204
 carrot 124
 carrycot 75
 cartilage 17
 carton 317
 cartoon 178
 carve v 79
 carving fork 68
 case 51
 cash v 97
 cash machine 97
 cashewnut 129
 cashewnuts 151
 cashier 96, 106
 casino 261
 Caspian Sea 313
 cassava 124
 casserole dish 69
 cassette player 269
 cassette tape 269
 cast 254
 cast v 245
 castle 300
 casual 34
 casual wear 33
 cat 290
 catalogue 168
 catamaran 215
- cataract 51
 catch v 220, 227, 229, 245
 catcher 229
 caterpillar 295
 cathedral 300
 catheter 53
 cauliflower 124
 cave 284
 CD player 268
 cedar 296
 ceiling 62
 celebration 140
 celebration cakes 141
 celebrations 27
 celeriac 124
 celery 122
 cell 181
 cello 256
 cement 186
 cement mixer 186
 centimetre 310
 centipede 295
 Central African Republic 317
 central processing unit 176
 central reservation 194
 centre 164
 centre circle 222, 224, 226
 centre field 228
 centre line 226
 centreboard 241
 century 307
 ceramic hob 66
 cereal 130, 156
 cervical vertebrae 17
 cervix 20, 52
 Chad 317
 chain 36, 206
 chair 64
 chair v 174
 chairlift 246
 chalk 85, 162, 288
 chamber 283
 champagne 145
 championship 230
 change v 209
 change a wheel v 203
 change channel v 269
 change gear v 207
 changing bag 75
 changing mat 74
 changing room 104
 channel 178
 charcoal 266, 275
 charge 94, 180
 chart 48
 chassis 203
 check-in v 212
 check-in desk 213
 checkout 106
 check-up 50
 cheddar 142
 cheek 14
 cheerleader 220
 cheese 136, 156
 chef 152, 190
 chef's hat 190
 chemist 108
 chemistry 162
- cheque 96
 chequebook 96
 cherry 126
 cherry tomato 124
 chess 272
 chessboard 272
 chest 12
 chest of drawers 70
 chest press 251
 chestnut 129
 chewing gum 113
 chick 185
 chick peas 131
 chicken 119, 185
 chicken burger 155
 chicken coop 185
 chicken nuggets 155
 chicken pox 44
 chicory 122
 child 23, 31
 child lock 75
 child seat 198, 207
 childbirth 53
 children 23
 children's clothing 30
 children's department 104
 children's ward 48
 child's meal 153
 Chile 315
 chili 143
 chill 44
 chilli 124, 132
 chimney 58
 chin 14
 China 318
 china 105
 chip v 233
 chipboard 79
 chiropractic 54
 chisel 81, 275
 chives 133
 chamber 113
 chocolate bar 113
 chocolate cake 140
 chocolate chip 141
 chocolate coated 140
 chocolate milkshake 149
 chocolate spread 135
 choir 301
 choke v 47
 chop 119, 237
 chopping board 68
 chorizo 143
 choux pastry 140
 christening 26
 Christmas 27
 chrysanthemum 110
 chuck 78
 church 298, 300
 chutney 134
 cider 145
 cider vinegar 135
 cigar 112
 cigarettes 112
 cinema 255, 299
 cinema hall 255
 cinnamon 133
 circle 165, 254
- circular saw 78
 circuit training 251
 circumference 164
 cistern 61
 citrus fruit 126
 city 299
 clam 121
 clamp 78, 166
 clamp stand 166
 clapper board 179
 clarinet 257
 clasp 36
 classical music 255, 259
 classroom 162
 claw 291
 clay 85, 275
 clean v 77
 clean clothes 76
 cleaned 121
 cleaner 188
 cleaning equipment 77
 cleaning fluid 51
 cleanser 41
 clear honey 134
 cleat 240
 cleaver 68
 clementine 126
 client 38, 175, 180
 cliff 285
 climber 87
 climbing frame 263
 clinic 48
 clipboard 173
 clitoris 20
 clock 62
 clock radio 70
 closed 260, 321
 clothes line 76
 clothes peg 76
 clothing 205
 cloud 287
 cloudy 286
 clove 125
 clover 297
 cloves 133
 club 273
 club sandwich 155
 clubhouse 232
 clutch 200, 204
 coach 196
 coal 288
 coast 285
 coaster 150
 coastguard 217
 coat 32
 coat hanger 70
 cockatoo 293
 cockerel 185
 cockle 121
 cockpit 210
 cockroach 295
 cocktail 151
 cocktail shaker 150
 cocoa powder 148
 coconut 129
 cocoon 295
 cod 120
 coffee 144, 148, 153, 156, 184

- coffee cup 65
 coffee machine 148, 150
 coffee milkshake 149
 coffee spoon 153
 coffee table 62
 cog 206
 coin 97
 coin phone 99
 coin return 99
 cola 144
 colander 68
 cold 44, 286, 321
 cold tap 72
 cold-pressed oil 135
 collage 275
 collar 32
 collar bone 17
 colleague 24
 collection 98
 college 168
 Colombia 315
 colony 315
 colouring pencil 163
 colours 39, 274
 comb 38
 comb v 38
 combat sports 236
 combine harvester 182
 comedy 255
 comet 280
 comic 112
 commis chef 152
 commission 97
 communications 98
 commuter 208
 Comoros 317
 compact 40
 compact disc 269
 company 175
 compartment 209
 compass 165, 312, 240
 complaint 94
 complexion 41
 compliments slip 173
 compost 88
 compost heap 85
 computer 172, 176
 concealer 40
 conceive v 20
 conception 52
 concert 255, 258
 concertina file 173
 concourse 209
 concrete block 187
 concussion 46
 condensed milk 136
 conditioner 38
 condom 21
 conductor 256
 cone 164, 187
 confectioner 113
 confectionery 107, 113
 confident 25
 confused 25
 conglomerate 288
 Congo 317
 conifer 86
 connect v 177
 connection 212
 conning tower 215
 console 269
 constellation 281
 construction 186
 consultant 49
 consultation 45
 contact lenses 51
 container 216, 311
 container port 216
 container ship 215
 continent 282, 315
 contraception 21, 52
 contraction 52
 control tower 212
 controller 269
 controls 201, 204
 convector heater 60
 convenience food 107
 convertible 199
 convoyer belt 106
 cooked meat 118, 143
 cooking 67
 coolant reservoir 202
 cooling rack 69
 co-pilot 211
 copper 289
 copy v 172
 cor anglais 257
 coral reef 285
 cordless phone 99
 core 127
 coriander 133
 cork 134
 corkscrew 150
 corn 130, 184
 corn bread 139
 corn oil 135
 cornea 51
 corner 223
 corner flag 223
 cornice 300
 corset 35
 Corsica 316
 Costa Rica 314
 costume 255
 cot 74
 cottage cheese 136
 cottage garden 84
 cotton 184, 277
 cotton balls 41
 cough 44
 cough medicine 108
 counsellor 55
 count v 165
 counter 96, 98, 100, 142, 272
 country 259, 315
 couple 24
 courgette 125
 courier 99
 courses 153
 court 226
 court case 180
 court date 180
 court officer 180
 court official 180
 courtroom 180
 courtyard 58, 84
 couscous 130
 cousin 22
 cow 185
 cow's milk 136
 crab 121, 295
 cracked wheat 130
 cradle 95
 crafts 275
 cramp 239
 cramps 44
 cranberry 127
 crane 187, 216, 292
 crash barrier 195
 crater 283
 crayfish 121
 cream 109, 137, 140, 157
 cream cheese 136
 cream pie 141
 crease 225
 credit card 96
 creel 245
 creeper 87
 crème caramel 141
 crème pâtisserie 140
 crêpe 155
 crescent moon 280
 crew 241
 crew hatch 281
 cricket 225, 295
 cricket ball 225
 cricketer 225
 crime 94
 criminal 181
 criminal record 181
 crisp 127
 crispbread 139, 156
 crisper 67
 crisps 113, 151
 Croatia 316
 crochet 277
 crochet hook 277
 crockery 64
 crockery and cutlery 65
 crocodile 293
 crocodile clip 167
 croissant 156
 crop 39, 183
 crops 184
 cross trainer 250
 crossbar 207, 222, 235
 cross-country skiing 247
 crow 292
 crown 50
 crucible 166
 crushed 132
 crust 139, 282
 cry v 25
 crystal healing 55
 Cuba 314
 cube 164
 cucumber 125
 cuff 32, 45
 cufflink 36
 cultivate v 91
 cultivator 182
 cumin 132
 curb 298
 cured 118, 159, 143
 curler 38
 curling 247
 curling tongs 38
 curly 39
 currant 129
 current account 96
 curry 158
 curry powder 132
 curtain 63, 254
 curved 165
 cushion 62
 custard 140
 customer 96, 104, 106, 152
 customer service department 175
 customer services 104
 customs 212
 customs house 216
 cut 46
 cut v 38, 79, 277
 cuticle 15
 cutlery 64
 cuts 119
 cutting 91
 cuttlefish 121
 cycle v 207
 cycle lane 206
 cycling 263
 cylinder 164
 cylinder head 202
 cymbals 257
 Cyprus 316
 Czech Republic 316

D
 daffodil 111
 dairy 107
 dairy farm 183
 dairy produce 136
 daisy 110, 297
 dam 300
 dance 259
 dance academy 169
 dancer 191
 dandelion 123, 297
 dandruff 39
 dark 41, 321
 darkroom 271
 darn v 277
 dartboard 273
 darts 273
 dashboard 201
 date 129, 306
 daughter 22
 daughter-in-law 22
 dawn 305
 day 305, 306
 dead ball line 221
 deadhead v 91
 deal v 273
 debit card 96
 decade 307
 decay 50
 December 306
 deciduous 86
 decimal 165
 deck 214
 deck chair 265
 decking 85
 decorating 82
 decoration 141
 decorator 82
 deep end 239
 deep fried 159
 deep sea fishing 245
 deer 291
 defence 181, 220
 defendant 181
 defender 223
 defending zone 224
 defrost v 67
 degree 169
 delay 209
 deli 107
 delicatessen 142
 delivery 52, 98
 deltoïd 16
 Democratic Republic of the Congo 317
 Denmark 316
 denomination 97
 denominator 165
 dental care 108
 dental floss 50, 72
 dental hygiene 72
 dental x-ray 50
 dentist 50, 189
 dentist's chair 50
 dentures 50
 deodorant 73
 deodorants 108
 department 169
 department store 105
 departments 49
 departure lounge 213
 departures 213
 depth 165
 dermatology 49
 descaled 121
 desert 285
 desiccated 129
 designer 191, 277
 desk 162, 172
 desktop 177
 desktop organizer 172
 dessert 153
 desserts 140
 destination 213
 detached 58
 detective 94
 detergent 77
 deuce 230
 develop v 271
 diabetes 44
 diagonal 164
 dial v 99
 diameter 164
 diamond 273, 288
 diaphragm 19, 21
 diarrhoea 44, 109
 diary 175
 dice 272

- dictionary 163
 die v 26
 diesel 199
 diesel train 208
 difficult 321
 dig v 90, 227
 digestive 19
 digital 269
 digital camera 270
 dilation 52
 dill 133
 dimensions 165
 dimple 15
 dining car 209
 dining room 64
 dinner 64, 158
 dinner plate 65
 diopter 51
 diploma 169
 dipstick 202
 direct current 60
 direct debit 96
 directions 260
 director 254
 directory enquiries 99
 dirt bike 205
 dirty washing 76
 disabled parking 195
 discharged 48
 disconnected 99
 discuss 234
 discuss v 163
 disembark v 217
 dishwasher 66
 disinfectant solution 51
 disk 176
 dispensary 108
 disposable 109
 disposable camera 270
 disposable nappy 30
 disposable razor 73
 dissertation 169
 distance 310
 distributor 203
 district 315
 dive 239
 dive v 238
 diver 238
 diversion 195
 divide v 165
 divided by 165
 dividends 97
 divider 173, 194
 divorce 26
 Diwali 27
 DJ 179
 Djibouti 317
 do not bend v 98
 dock 214, 216
 dock v 217
 doctor 45, 189
 doctorate 169
 documentary 178
 dog 290
 dog sledding 247
 doll 75
 doll's house 75
 dolphin 290
- dome 300
 domestic flight 212
 Dominica 314
 Dominican Republic 314
 dominoes 273
 donkey 185
 door 196, 198, 209
 door chain 59
 door knob 59
 door knocker 59
 door lock 200
 doorbell 59
 doormat 59
 dormer 58
 dorsal fin 294
 dosage 109
 double 151
 double bass 256
 double bassoon 257
 double bed 71
 double cream 137
 double room 100
 double-decker bus 196
 doubles 230
 dough 138
 Dover sole 120
 down 320
 downhill skiing 247
 download v 177
 dragonfly 295
 drain 61, 72, 299
 drain cock 61
 drainage 91
 draining board 67
 draughts 272
 draw 223
 draw v 162
 drawer 66, 70, 172
 drawer unit 172
 drawing 275
 drawing pin 173
 dress 31, 34
 dressage 243
 dressed 159
 dressed chicken 119
 dressing 47, 158
 dressing gown 31, 32
 dressing table 71
 dribble v 223
 dried flowers 111
 dried fruit 156
 drill 50
 drill v 79
 drill bit 78
 drill bits 80
 drinking cup 75
 drinking fountain 262
 drinks 107, 144, 156
 drip 53
 drive v 195, 233
 driver 196
 driver's cab 208
 driver's seat 196
 driveshaft 202
 drop anchor v 217
 dropper 109, 167
 drops 109
- dropshot 230
 drown v 239
 drum 258
 drum kit 258
 drummer 258
 dry 39, 41, 130, 145, 286, 321
 dry v 76
 dry cleaners 115
 dry dock 217
 dual carriageway 195
 duck 119, 185
 duck egg 137
 duckling 185
 duffel coat 31
 dugout 229
 dumb bell 251
 dumper truck 187
 dungarees 30
 dunk v 227
 duodenum 18
 dusk 305
 dust v 77
 dust pan 77
 duster 77
 dustsheet 83
 duty-free shop 213
 duvet 71
 DVD disk 269
 DVD player 268
 dyed 39
 dynamo 207
- E**
 eagle 292
 ear 14
 early 305, 320
 earring 36
 Earth 280, 282
 earthenware dish 69
 earthing 60
 earthquake 283
 easel 174, 274
 east 312
 East Timor 319
 Easter 27
 easy 321
 easy cook 130
 eat v 64
 eat-in 154
 eating 75
 eau de toilette 41
 eaves 58
 éclair 140
 eclipse 280
 economics 169
 economy class 211
 Ecuador 315
 eczema 44
 Edam 142
 edge 246
 editor 191
 eel 294
 egg 20
 egg cup 65, 137
 egg white 137
 eggs 137
 Egypt 317
- eight 308
 eight hundred 308
 eighteen 308
 eighteenth 309
 eighth 309
 eightieth 309
 eighty 308
 ejaculatory duct 21
 El Salvador 314
 elbow 13
 electric blanket 71
 electric drill 78
 electric guitar 258
 electric razor 73
 electric shock 46
 electric train 208
 electrical goods 105, 107
 electrician 188
 electricity 60
 electricity meter 60
 elephant 291
 eleven 308
 eleventh 309
 elm 296
 email 98, 177
 email account 177
 email address 177
 embarrassed 25
 embossed paper 83
 embroidery 277
 embryo 52
 emerald 288
 emergency 46
 emergency exit 210
 emergency lever 209
 emergency phone 195
 emergency room 48
 emergency services 94
 emigrate v 26
 emotions 25
 employee 24
 employer 24
 empty 321
 emulsion 83
 enamel 50
 encore 255
 encyclopedia 163
 end 321
 end zone 220
 endive 123
 endline 226
 endocrine 19
 endocrinology 49
 engaged/busy 99
 engaged couple 24
 engine 202, 204, 208, 210
 engine room 214
 engineering 169
 English breakfast 157
 english mustard 135
 engraving 275
 enlarge v 172
 enlargement 271
 enquiries 168
 ENT 49
 entrance 59
 entrance fee 260
 envelope 98, 173
- environment 280
 epidural 52
 epiglottis 19
 epilepsy 44
 episiotomy 52
 equals 165
 equation 165
 equator 283
 equipment 233, 238
 equipment 165
 Equatorial Guinea 317
 equity 97
 Eritrea 317
 erupt v 283
 escalator 104
 espresso 148
 essay 163
 essential oils 55
 estate 199
 estate agent 189
 estate agent's 115
 Estonia 316
 estuary 285
 Ethiopia 317
 eucalyptus 296
 Europe 316
 evening 305
 evening dress 34
 evening menu 152
 events 243, 247
 evergreen 86
 evidence 181
 examination 163
 excess baggage 212
 exchange rate 97
 excited 25
 excuse me 322
 executive 174
 exercise bike 250
 exercises 251
 exfoliate v 41
 exhaust pipe 203, 204
 exhibit v 261
 exhibition 261
 exit 210
 exit ramp 194
 exosphere 286
 expectant 52
 experiment 166
 expiry date 109
 exposure 271
 extend v 251
 extension 58
 extension lead 78
 exterior 198
 extra time 223
 extraction 50
 extractor 66
 eye 14, 51, 244, 276
 eye shadow 40
 eye test 51
 eyebrow 14, 51
 eyebrow brush 40
 eyebrow pencil 40
 eyecup 269
 eyelash 14, 51
 eyelet 37
 eyelid 51

- eyeliner 40
eyepiece 167
- F**
- fabric 277
fabric conditioner 76
face 14
face cream 73
face mask 225
face pack 41
face powder 40
face-off circle 224
facial 41
factory 299
faint v 25, 44
fair 41
fairground 262
fairway 232
falcon 292
Falkland Islands 315
fall 237
fall in love v 26
Fallopian tube 20
family 22
famous ruin 261
fan 60, 202
fan belt 203
fans 258
far 320
fare 197, 209
farm 182, 183, 184
farmer 182, 189
farmhouse 182
farmland 182
farmyard 182
fashion 277
fast 321
fast food 154
fast forward 269
fastening 37
fat 119, 321
fat free 137
father 22
father-in-law 23
fault 230
fax 98, 172
fax machine 172
feather 293
feature film 269
February 306
feed v 183
fejjoa 128
female 12, 20
feminine hygiene 108
femur 17
fence 85, 182, 243
fencing 249
feng shui 55
fennel 122, 133
fennel seeds 133
fenugreek 132
fern 86
ferry 215, 216
ferry terminal 216
fertilization 20
fertilize v 91
fertilizer 91
festivals 27
- fever 44
fiancé 24
fiancée 24
fibre 127
fibula 17
field 182, 222, 228, 234
field v 225, 229
field hockey 224
fifteen 308
fifteenth 309
fifth 309
fiftieth 309
fifty 308
fifty five thousand, five hundred 309
fifty thousand 309
fig 129
fighter plane 211
figure skating 247
Fiji 319
filament 60
file 81, 172, 177
filing cabinet 172
fill v 82
filler 83
fillet 119, 121
filleted 121
filling 50, 140, 155
film 260, 271
film set 179
film spool 271
filo pastry 140
filter 270
filter coffee 148
filter paper 167
fin 210
finance 97
financial advisor 97
fingerprint 94
finial 300
finishing line 234
Finland 316
fire 95
fire alarm 95
fire brigade 95
fire engine 95
fire escape 95
fire extinguisher 95
fire fighters 95
fire station 95
firelighter 266
fireman 189
fireplace 63
firm 124
first 309
first aid 47
first aid box 47
first floor 104
first night 254
fish 107, 120, 294
fish and chips 155
fish farm 183
fish slice 68
fisherman 189
fishhook 244
fishing 244, 245
fishing boat 217
fishing permit 245
- fishing port 217
fishing rod 244
fishmonger 188
fishmonger's 114, 120
fist 15, 237
fitness 250
five 308
five hundred 308
flag 221, 232
flageolet beans 131
flakes 132
flamingo 292
flan 142
flan dish 69
flare 240
flash 270
flash gun 270
flask 166
flat 59, 256
flatbread 139
flat race 243
flat wood bit 80
flavoured oil 134
flax 184
fleece 74
flesh 124, 127, 129
flex v 251
flight attendant 210
flight number 213
flint 288
flipchart 174
flip-flop 37
flipper 239, 290
float 238, 244
float ball 61
flock 183
flood 287
floor 58, 62, 71
floor exercises 235
floor plan 261
florentine 141
florete 122
florist 110, 188
floss v 50
floors 138
flower 297
flowerbed 85, 90
flowering plant 297
flowering shrub 87
flowers 110
flu 44
flute 139, 257
fly 244, 295
fly v 211
fly fishing 245
flyover 194
flysheet 266
foal 185
focus v 271
focusing knob 167
foetus 52
fog 287
foil 249
folder 177
foliage 110
folk music 259
follicle 20
font 177
- food 118, 130, 149
food hall 105
food processor 66
foot 12, 15, 310
football 220, 222
football field 220
football player 220
football strip 31, 222
footballer 222
footboard 71
footpath 262
footstrap 241
for 320
forceps 53, 167
forearm 12
forecourt 199
forehand 231
forehead 14
foreign currency 97
foreskin 21
forest 285
fork 65, 88, 153, 207
fork-lift truck 186, 216
formal garden 84
formal gardens 262
fortieth 309
fortnight 307
forty 308
forty minutes 304
forward 222
foul 222, 226
foul ball 228
foul line 229
foundation 40
fountain 85
four 308
four hundred 308
four-door 200
fourteen 308
fourteenth 309
fourth 309
four-wheel drive 199
fox 290
foxglove 297
fraction 165
fracture 46
fragile 98
fragrance 130
frame 51, 62, 206, 267
frame counter 270
France 316
freckle 15
free 321
free kick 222
free range 118
free weights 250
freesia 110
free-throw line 226
freeze 287
freezer v 67
freezer 67
freight train 208
freighter 215
French bean 122
French fries 154
French Guiana 315
French horn 257
french mustard 135
- french pleat 39
French toast 157
frequency 179
fresh 121, 127, 130
fresh cheese 136
fresh fruit 157
freshwater fishing 245
fret 258
fretsaw 81
Friday 306
fridge-freezer 67
fried 159
fried chicken 155
fried egg 157
friend 24
frieze 301
frog 294
from 320
front crawl 239
front door 58
front wheel 196
frontal 16
frost 287
froth 148
frown 25
frozen 121, 124
frozen food 107
frozen yoghurt 137
fruit 107, 126, 128
fruit bread 139
fruit cake 140
fruit farm 183
fruit gum 113
fruit juice 127, 156
fruit tart 140
fruit yoghurt 157
fry v 67
frying pan 69
fuel gauge 201
fuel tank 204
full 64, 266, 321
full board 101
full moon 280
fumble 220
funeral 26
funnel 166, 214
furniture shop 115
furrow 183
fuse 60
fuse box 60, 203
fuselage 210
- G**
- gable 300
Gabon 317
Galapagos Islands 315
galaxy 280
gale 286
galley 214
gallon 311
gallop 243
galvanised 79
Gambia 317
game 119, 230, 273
game show 178
games 272
gangway 214

- garage 58, 199
 garden 84
 garden centre 115
 garden features 84
 garden pea 122
 garden plants 86
 garden styles 84
 garden tools 88
 gardener 188
 gardening 90
 gardening gloves 89
 gardens 261
 garland 111
 garlic 125, 132
 garlic press 68
 garnet 288
 garter 35
 gas burner 61
 gasket 61
 gate 85, 182, 247
 gate number 213
 gauze 47, 167
 gear lever 207
 gearbox 202, 204
 gears 206
 gearstick 201
 gel 38, 109
 gems 288
 generation 23
 generator 60
 genitals 12
 geography 162
 geometry 165
 Georgia 318
 gerbera 110
 Germany 316
 get a job v 26
 get married v 26
 get up v 71
 geyser 285
 Ghana 317
 giant slalom 247
 gifts shop 114
 gill 294
 gin 145
 gin and tonic 151
 ginger 39, 125, 133
 giraffe 291
 girder 186
 girl 23
 girlfriend 24
 girth 242
 glacier 284
 gladiolus 110
 gland 19
 glass 69, 152
 glass bottle 166
 glass rod 167
 glasses 51, 150
 glassware 64
 glaze v 139
 glider 211, 248
 gliding 248
 gloss 83, 271
 glove 224, 233, 236, 246
 gloves 36
 glue 275
 glue gun 78
- gneiss 288
 go to bed v 71
 go to sleep v 71
 goal 221, 223, 224
 goal area 223
 goal line 220, 223, 224
 goalkeeper 222, 224
 goalpost 220, 222
 goat 185
 goatkeeper 222, 224
 goalpost 220, 222
 goat 185
 goat's cheese 142
 goat's milk 136
 goggles 238, 247
 going out 75
 gold 235, 289
 goldfish 294
 golf 232
 golf bag 233
 golf ball 233
 golf clubs 233
 golf course 232
 golf shoe 233
 golf trolley 233
 golfer 232
 gong 257
 good 321
 good afternoon 322
 good evening 322
 good morning 322
 good night 322
 goodbye 322
 goose 119, 293
 goose egg 137
 gooseberry 127
 gorge 284
 gorilla 291
 gothic 301
 grade 163
 graduate 169
 graduate v 26
 graduation ceremony 169
 graft v 91
 grains 130
 gram 310
 granary bread 139
 grandchildren 23
 granddaughter 22
 grandfather 22
 grandmother 22
 grandparents 23
 grandson 22
 granite 288
 grape juice 144
 grapefruit 126
 grapeseed oil 134
 graphite 289
 grass 86, 262
 grass bag 88
 grasshopper 295
 grassland 285
 grate v 67
 grated cheese 136
 grater 68
 gratin dish 69
 gravel 88
 gravity 280
 graze 46
 greasy 39
- Greece 316
 green 129, 232, 274
 green olive 143
 green peas 131
 green salad 158
 green tea 149
 greengrocer 188
 greengrocer's 114
 greenhouse 85
 Greenland 314
 Grenada 314
 grey 39, 274
 grill v 67
 grill pan 69
 grilled 159
 groceries 106
 grocer's 114
 groin 12
 groom 243
 ground 132
 ground coffee 144
 ground cover 87
 ground floor 104
 ground sheet 267
 groundnut oil 135
 group therapy 55
 grout 83
 guard 236
 Guatemala 314
 guava 128
 guest 64, 100
 guidebook 260
 guided tour 260
 guilty 181
 Guinea 317
 Guinea-Bissau 317
 guitarist 258
 gull 292
 gum 50
 gun 94
 gutter 58, 299
 guy rope 266
 Guyana 315
 gym 101, 250
 gym machine 250
 gymnast 235
 gymnastics 235
 gynaecologist 52
 gynaecology 49
 gypsophila 110
- H**
 haberdashery 105
 hacksaw 81
 haddock 120
 haemorrhage 46
 hail 286
 hair 14, 38
 hair dye 40
 hairband 38
 hairdresser 38, 188
 hairdresser's 115
 hairdryer 38
 hairpin 38
 hairspray 38
 hairtie 39
 Haiti 314
 half an hour 304
- half board 101
 half time 223
 half-litre 311
 hall of residence 168
 halibut fillets 120
 Halloween 27
 hallway 59
 halter 243
 halter neck 35
 ham 119, 143, 156
 hammer 80
 hammer v 79
 hammock 266
 hamper 263
 hamster 290
 hamstring 16
 hand 13, 15
 hand drill 81
 hand fork 89
 hand luggage 211, 213
 hand rail 59
 hand saw 89
 hand towel 73
 handbag 37
 handbrake 203
 handcuffs 94
 handicap 233
 handkerchief 36
 handle 36, 88, 106, 187, 200, 230
 handlebar 207
 handles 37
 handrail 196
 handsaw 80
 handset 99
 hang v 82
 hang-glider 248
 hang-gliding 248
 hanging basket 84
 hanging file 173
 happy 25
 harbour 217
 harbour master 217
 hard 129, 321
 hard cheese 136
 hard drive 176
 hard hat 186
 hard shoulder 194
 hardboard 79
 hardware 176
 hardware shop 114
 hardwood 79
 haricot beans 131
 harness race 243
 harp 256
 harvest v 91, 183
 hat 36
 hatchback 199
 have a baby v 26
 Hawaii 314
 hay 184
 hayfever 44
 hazard 195
 hazard lights 201
 hazelnut 129
 hazelnut oil 134
 head 12, 19, 81, 230
 head v 222
- head injury 46
 head office 175
 head teacher 163
 headache 44
 headboard 70
 headlight 198, 205
 headphones 268
 headrest 200
 headsail 240
 health 44
 health centre 168
 health food shop 115
 heart 18, 119, 122, 273
 heart attack 44
 heater 60
 heater controls 201
 heather 297
 heating element 61
 heavy 321
 heavy metal 259
 hedge 85, 90, 182
 hedgehog 290
 heel 13, 15, 37
 height 165
 height bar 45
 helicopter 211
 hello 322
 helmet 95, 204, 206, 220, 224, 228
 hem 34
 hematite 289
 hen's egg 137
 herb 55, 86
 herb garden 84
 herbaceous border 85
 herbal remedies 108
 herbal tea 149
 herbalism 55
 herbicide 183
 herbs 133, 134
 herbs and spices 132
 herd 183
 hexagon 164
 hi-fi system 268
 high 321
 high chair 75
 high dive 239
 high heel shoe 37
 high jump 235
 high speed train 208
 highlights 39
 hiking 263
 hill 284
 Himalayas 313
 hip 12
 hippopotamus 291
 historic building 261
 history 162
 history of art 169
 hit v 224
 hob 67
 hockey 224
 hockey stick 224
 hoe 88
 hold 215, 237
 holdall 37
 hole 232
 hole in one 233

- hole punch 173
 holiday 212
 holiday brochure 212
 holy 296
 home 58
 home delivery 154
 home entertainment 268
 home furnishings 105
 home plate 228
 homeopathy 55
 homework 163
 homogenised 137
 Honduras 314
 honeycomb 135
 honeymoon 26
 honeysuckle 297
 hood 31, 75
 hoof 242, 291
 hook 187, 276
 hoop 226, 277
 horizontal bar 235
 hormone 20
 horn 201, 204, 291
 horror film 255
 horse 185, 235, 242
 horse race 243
 horse riding 242, 263
 horseradish 125
 horseshoe 242
 hose 95
 hose reel 89
 hosepipe 89
 hospital 48
 host 64
 hostess 64
 hot 124, 286, 321
 hot chocolate 144, 156
 hot dog 155
 hot drinks 144
 hot tap 72
 hot-air balloon 211
 hotel 100, 264
 hot-water bottle 70
 hour 304
 hour hand 304
 house 58
 household products 107
 hovercraft 215
 hub 206
 hubcap 202
 hull 214, 240
 humerus 17
 humid 286
 hummingbird 292
 hump 291
 hundred 308
 hundred and ten 308
 hundred thousand 308
 hundredth 309
 Hungary 316
 hungry 64
 hurdles 235
 hurricane 287
 husband 22
 husk 130
 hydrant 95
 hydrofoil 215
 hydrotherapy 55
 hypnotherapy 55
 hypoallergenic 41
 hypotenuse 164
I
 ice 120, 287
 ice and lemon 151
 ice bucket 150
 ice climbing 247
 ice cream 149
 ice cube 151
 ice hockey 224
 ice hockey player 224
 ice hockey rink 224
 ice maker 67
 ice-cream 137
 iced coffee 148
 iced tea 149
 ice-skate 224
 ice-skating 247
 icicle 287
 icing 141
 icon 177
 identity badge 189
 identity tag 53
 igneous 288
 ignition 200
 iguana 293
 illness 44
 immigration 212
 impotent 20
 in 320
 in brine 143
 in front of 320
 in oil 143
 in sauce 159
 in syrup 159
 inbox 177
 inch 310
 incisor 50
 incubator 53
 index finger 15
 India 318
 Indian Ocean 312
 indicator 198, 204
 indigo 274
 Indonesia 319
 induce labour v 53
 industrial estate 299
 infection 44
 infertile 20
 infield 228
 inflatable dinghy 215
 information 261
 information screen 213
 in-goal area 221
 inhaler 44, 109
 injection 48
 injury 46
 ink 275
 ink pad 173
 inlet 61
 inner core 282
 inner tube 207
 inning 228
 innocent 181
 inoculation 45
 insect repellent 108, 267
 inside 320
 inside lane 194
 insomnia 71
 inspector 94
 install v 177
 instant camera 270
 instep 15
 instructions 109
 instruments 256, 258
 insulating tape 81
 insulation 61
 insulin 109
 insurance 203
 intensive care unit 48
 inter-city train 209
 intercom 59
 intercostal 16
 intercourse 20
 interest rate 96
 interior 200
 internal systems 60
 international flight 212
 internet 177
 intersection 298
 interval 254
 interviewer 179
 into 320
 in-tray 172
 invertebrates 295
 investigation 94
 investment 97
 ionosphere 286
 Iran 318
 Iraq 318
 Ireland 316
 iris 51, 110
 iron 76, 109, 233, 289
 iron v 76
 ironing board 76
 island 282
 Israel 318
 Italy 316
 itinerary 260
 IUD 21
 Ivory Coast 317
J
 jack 203, 273
 jacket 32, 34
 jade 288
 jam 134, 156
 Jamaica 314
 January 306
 Japan 318
 jar 134, 311
 javelin 234
 jaw 14, 17
 jazz 259
 jeans 31
 jelly bean 113
 jellyfish 295
 Jerusalem artichoke 125
 jet 288
 jet skiing 241
 jetty 217
 jeweller 188
 jeweller's 114
 jewellery 36
 jewellery box 36
 jewellery making 275
 jigsaw 78
 jigsaw puzzle 273
 jodhpurs 242
 jog on the spot 251
 jogging 251, 263
 joint 17, 119
 joker 273
 Jordan 318
 journal 168
 journalist 190
 judge 180
 judo 236
 jug 65
 juices and milkshakes 149
 juicy 127
 July 306
 jump 237, 243
 jump v 227
 jump ball 226
 junction 194
 June 306
 Jupiter 280
 jury 180
 jury box 180
K
 kale 123
 Kaliningrad 316
 kangaroo 291
 karate 236
 kayak 241
 Kazakhstan 318
 kebab 155, 158
 keel 214
 keep net 244
 kendo 236
 Kenya 317
 kernel 122, 129, 130
 ketchup 135
 kettle 66
 kettledrum 257
 key 59, 80, 176, 207
 keyboard 172, 176, 258
 keypad 97, 99
 kick 237, 239
 kick v 221, 223
 kickboxing 236
 kickstand 207
 kid 185
 kidney 18, 119
 kilogram 310
 kilometre 310
 king 272, 273
 king prawn 121
 kippers 157
 kitchen 66, 152
 kitchen knife 68
 kitchenware 68, 105
 kitten 290
 kiwifruit 128
 knead v 138
 knee 12
 knee pad 205
 knee support 227
 kneecap 17
 knee-length 34
 knickers 35
 knife 65, 80
 knife sharpener 68, 118
 knight 272
 knitting 277
 knitting needle 277
 knock out 237
 knuckle 15
 koala 291
 kohlrabi 123
 koi carp 294
 kumquat 126
 kung fu 236
 Kuwait 318
 Kyrgyzstan 318
L
 label 172
 labels 89
 labia 20
 laboratory 166
 lace 35, 37
 lace bobbin 277
 lace making 277
 lace-up 37
 lacrosse 249
 lactose 137
 ladder 95, 186
 ladle 68
 ladybird 295
 lake 285
 lamb 118, 185
 lamp 62, 207, 217
 land 282
 land v 211
 landing 59
 landing gear 210
 landing net 244
 landlord 58
 landscape 271, 284
 landscape v 91
 lane 234, 238
 languages 162
 Laos 318
 lapel 32
 laptop 175
 larch 296
 large 321
 large intestine 18
 larynx 19
 last week 307
 lat 16
 late 305
 later 304
 latitude 283
 Latvia 316
 laugh v 25
 launch 281
 launch pad 281
 launderette 115
 laundry 76
 laundry basket 76
 laundry service 101
 lava 283
 law 169, 180
 lawn 85, 90
 lawn rake 88

- lawnmower 88, 90
 lawyer 180, 190
 lawyer's office 180
 laxative 109
 lay the table v 64
 lead singer 258
 leaded 199
 leaf 122, 296
 leaflets 96
 league 223
 lean meat 118
 learn v 163
 leather shoe 37
 leather shoes 32
 leathers 205
 Lebanon 318
 lecture theatre 169
 lecturer 169
 leek 125
 left 260
 left field 228
 left-hand drive 201
 leg 12, 119
 leg pad 225
 leg press 251
 legal advice 180
 legal department 175
 leggings 31
 leisure 258, 254, 264
 lemon 126
 lemon curd 134
 lemon grass 133
 lemon sole 120
 lemonade 144
 length 165, 310
 lens 270
 lens (eye) 51
 lens (glasses) 51
 lens cap 270
 lens case 51
 Lesotho 317
 lesson 163
 let! 231
 letter 98
 letterbox 58, 99
 letterhead 173
 lettuce 123
 lever 61, 150
 lever arch file 173
 Liberia 317
 librarian 168, 190
 library 168, 299
 library card 168
 Libya 317
 licence plate 198
 liquorice 113
 lid 61, 66
 Liechtenstein 316
 life events 26
 life jacket 240
 life raft 240
 lifeboat 214
 lifebuoy 240
 lifeguard 239, 265
 lifeguard tower 265
 lift 59, 100, 104
 ligament 17
 light 178, 321
 light a fire v 266
 light aircraft 211
 light bulb 60
 lighter 112
 lighthouse 217
 lighting 105
 lightmeter 270
 lightning 287
 lights 94
 lights switch 201
 lily 110
 lime 126, 296
 limestone 288
 limousine 199
 line 244
 line judge 220
 line of play 233
 linen 105, 277
 linen basket 76
 lines 165
 linesman 223, 230
 lingerie 35, 105
 lining 32
 lining paper 83
 link 36
 lintel 186
 lion 291
 lip 14
 lip brush 40
 lip gloss 40
 lip liner 40
 lipstick 40
 liqueur 145
 liquid 77
 liquid dispenser 311
 liquid measure 311
 literature 162, 169
 Lithuania 316
 litre 311
 little finger 15
 little toe 15
 live 60, 178
 live rail 209
 liver 18, 118
 livestock 183, 185
 living room 62
 lizard 293
 load v 76
 loaf 139
 loan 96, 168
 loans desk 168
 lob 230
 lobby 100, 255
 lobster 121, 295
 lock 59, 207
 lockers 239
 log on v 177
 loganberry 127
 logo 31
 loin 121
 lollipop 113
 long 32
 long jump 235
 long sight 51
 long wave 179
 long-grain 130
 long-handled shears 88
 longitude 283
 loofah 73
 loom 277
 loose leaf tea 144
 lorry 194
 lorry driver 190
 lose v 273
 loser 273
 lottery tickets 112
 love 230
 low 321
 luge 247
 luggage 100, 198, 213
 luggage department 104
 luggage hold 196
 luggage rack 209
 lumbar vertebrae 17
 lunar module 281
 lunch 64
 lunch menu 152
 lung 18
 lunge 251
 lupins 297
 lure 244
 Luxembourg 316
 lychee 128
 lymphatic 19
 lyrics 259
M
 macadamia 129
 mace 132
 Macedonia 316
 machine gun 189
 machinery 187
 mackerel 120
 macramé 277
 Madagascar 317
 magazine 112
 magazines 107
 magma 283
 magnesium 109
 magnet 167
 maid service 101
 mailbag 98, 190
 main course 153
 mains supply 60
 mainsail 240
 make a will v 26
 make friends v 26
 make bread 138
 malachite 288
 Malawi 317
 Malaysia 318
 Maldives 318
 male 12, 21
 Mali 317
 mallet 78, 275
 malt vinegar 135
 Malta 316
 malted drink 144
 mammals 290
 man 23
 manager 24, 174
 managing director 175
 manchego 142
 mane 242, 291
 mango 128
 mangosteen 128
 manhole 299
 manicure 41
 mantelpiece 63
 mantle 282
 manual 200
 map 195, 261
 maple 296
 maple syrup 134
 maracas 257
 marathon 234
 marble 288
 March 306
 margarine 137
 marina 217
 marinated 143, 159
 marine fishing 245
 marjoram 133
 mark v 227
 market 115
 marketing department 175
 marmalade 134, 156
 marrow 124
 Mars 280
 marshmallow 113
 martial arts 237
 martini 151
 marzipan 141
 mascara 40
 mashed 159
 masher 68
 mask 189, 228, 236, 239, 249
 masking tape 83
 masonry bit 80
 massage 54
 mast 240
 masters 169
 mat 54, 83, 235, 271
 match 230
 matches 112
 material 276
 materials 79, 187
 maternity 49
 maternity ward 48
 maths 162, 164
 mattress 70, 74
 Mauritiana 317
 Mauritius 317
 May 306
 maybe 322
 mayonnaise 135
 MDF 79
 meadow 285
 meal 64
 measles 44
 measure 150, 151
 measure v 310
 measurements 165
 measuring jug 69, 311
 measuring spoon 109
 meat 119
 meat and poultry 106
 meat tenderizer 68
 meatballs 158
 meathook 118
 mechanic 188, 203
 mechanical digger 187
 mechanics 202
 medals 235
 media 178
 medical examination 45
 medication 109
 medicine 109, 169
 medicine cabinet 72
 meditation 54
 Mediterranean Sea 313
 medium wave 179
 meeting 174
 meeting room 174
 melody 259
 melon 127
 memory 176
 men's clothing 32
 men's wear 105
 menstruation 20
 menu 148, 153, 154
 menubar 177
 mercury 289
 Mercury 280
 meringue 140
 mesosphere 286
 messages 100
 metacarpal 17
 metal 79
 metal bit 80
 metals 289
 metamorphic 288
 metatarsal 17
 meteor 280
 metre 310
 Mexico 314
 mica 289
 microlight 211
 microphone 179, 258
 microscope 167
 microwave oven 66
 midday 305
 middle finger 15
 middle lane 194
 midnight 305
 midwife 53
 migraine 44
 mile 310
 milk 136, 156
 milk v 183
 milk carton 136
 milk chocolate 113
 milkshake 137
 millennium 307
 millet 130
 milligram 310
 millilitre 311
 millimetre 310
 mince 119
 mineral 144
 minerals 289
 mini bar 101
 mini disk recorder 268
 minibus 197
 mint 113, 133
 mint tea 149
 minus 165
 minute 304
 minute hand 304

- minutes 174
 mirror 40, 63, 71, 167
 miscarriage 52
 Miss 23
 missile 211
 mist 287
 mitre block 81
 mitt 228
 mittens 30
 mix v 67, 138
 mixed salad 158
 mixing bowl 66, 69
 mixing desk 179
 moat 300
 mobile 74
 mobile phone 99
 model 169, 190
 model making 275
 modelling tool 275
 modem 176
 moisturizer 41
 molar 50
 Moldova 316
 mole 14
 Monaco 316
 Monday 306
 money 97
 Mongolia 318
 monitor 172, 176
 monitor 53
 monkey 291
 monkfish 120
 monopoly 272
 monorail 208
 monsoon 287
 month 306
 monthly 307
 monument 261
 Moon 280
 moonstone 288
 moor v 217
 mooring 217
 mop 77
 morning 305
 Morocco 317
 mortar 68, 167, 187
 mortgage 96
 Moses basket 74
 mosque 300
 mosquito 295
 mosquito net 267
 moth 295
 mother 22
 mother-in-law 23
 motor 88
 motor racing 249
 motorbike 204
 motorbike racing 249
 motorcross 249
 motorway 194
 moulding 63
 mountain 284
 mountain bike 206
 mountain range 282
 mouse 176, 290
 mousse 141
 mouth 14
 mouth guard 237
 mouthwash 72
 move 273
 mow v 90
 Mozambique 317
 mozzarella 142
 MP3 player 268
 Mr 23
 Mrs 23
 mudguard 205
 muffin 140
 muffin tray 69
 mug 65
 mulch v 91
 multiply v 165
 multivitamin tablets 109
 mumps 44
 mung beans 131
 muscles 16
 museum 261
 mushroom 125
 music 162
 music school 169
 musical 255
 musical score 255
 musical styles 259
 musician 191
 mussel 121, 295
 mustard 155
 mustard seed 131
 Myanmar 318
N
 naan bread 139
 nail 15, 80
 nail clippers 41
 nail file 41
 nail scissors 41
 nail varnish 41
 nail varnish remover 41
 Namibia 317
 nape 13
 napkin 65, 152
 napkin ring 65
 nappy 75
 nappy rash cream 74
 narrow 321
 nation 315
 national park 261
 natural 256
 natural fibre 31
 naturopathy 55
 nausea 44
 navel 12
 navigate v 240
 near 320
 nebula 280
 neck 12, 258
 neck brace 46
 necklace 36
 neckline 34
 nectarine 126
 needle 109, 276
 needle plate 276
 needle-nose pliers 80
 needlepoint 277
 negative 271
 negative electrode 167
 negligée 35
 neighbour 24
 neoclassical 301
 Nepal 318
 nephew 23
 Neptune 280
 nerve 19, 50
 nervous 19, 25
 net 217, 222, 226, 227, 231
 net v 245
 net curtain 63
 Netherlands 316
 nettle 297
 network 176
 neurology 49
 neutral 60
 neutral zone 224
 new 321
 new moon 280
 new potato 124
 New Year 27
 New Zealand 319
 newborn baby 53
 news 178
 newsagent 112
 newspaper 112
 newsreader 179, 191
 next week 306
 nib 163
 Nicaragua 314
 nickel 289
 niece 23
 Niger 317
 Nigeria 317
 night 305
 nightdress 35
 nightie 31
 nightwear 31
 nine 308
 nine hundred 308
 nineteen 308
 nineteen hundred 307
 nineteen hundred and one 307
 nineteen ten 307
 nineteenth 309
 ninetieth 309
 ninety 308
 ninth 309
 nipple 12
 no 322
 no entry 195
 no right turn 195
 no stopping 195
 non-smoking section 152
 non-stick 69
 noodles 158
 normal 39
 north 312
 North and Central America 314
 North Korea 318
 North pole 283
 North Sea 312
 northern hemisphere 283
 Norway 316
 nose 14, 210
 nose clip 238
 noseband 242
 nosebleed 44
 nosewheel 210
 nostril 14
 notation 256
 note 97, 256
 note pad 173
 notebook 163, 172
 notes 175, 191
 notice board 173
 nougat 113
 November 306
 now 304
 nozzle 89
 number 226
 numbers 308
 numerator 165
 nurse 45, 48, 52, 189
 nursery 74
 nursing 53
 nursing bra 53
 nut 80
 nutmeg 132
 nuts 151
 nuts and dried fruit 129
 nylon 277
O
 oak 296
 oar 241
 oats 130
 objective lens 167
 oboe 257
 obsidian 288
 obstetrician 52
 occupations 188, 190
 occupied 321
 ocean 282
 ocean liner 215
 octagon 164
 October 306
 octopus 121, 295
 odometer 201
 oesophagus 19
 off licence 115
 offal 118
 offers 106
 office 24, 172, 174
 office block 298
 office equipment 172
 office supplies 173
 off-piste 247
 off-side 223
 oil 142, 199
 oil paints 274
 oil tank 204
 oil tanker 215
 oils 134
 oily 41
 ointment 47, 109
 okra 122
 old 321
 olive oil 134
 olives 151
 Oman 318
 omelette 158
 on time 305
 on top of 320
 oncology 49
 one 308
 one billion 309
 one million 309
 one thousand 309
 one-way 194
 one-way system 298
 onion 124
 on-line 177
 onto 320
 onyx 289
 opal 288
 open 260, 321
 open sandwich 155
 open-top 260
 opera 255
 operating theatre 48
 operation 48
 operator 99
 ophthalmology 49
 opponent 236
 opposite 320
 optic 150
 optic nerve 51
 optician 51, 189
 orange 126, 274
 orange juice 148
 orangeade 144
 orbit 280
 orchestra 254, 256
 orchestra pit 254
 orchid 111
 order v 153
 oregano 133
 organic 91, 118, 122
 organic waste 61
 origami 275
 ornamental 87
 orthopaedy 49
 osteopathy 54
 ostrich 292
 otter 290
 ounce 310
 out 225, 228, 320
 out of bounds 226
 out of focus 271
 outdoor motor 215
 outbuilding 182
 outdoor activities 262
 outer core 282
 outfield 229
 outlet 61
 outpatient 48
 outside 320
 outside lane 194
 out-tray 172
 oval 164
 ovary 20
 oven 66
 oven glove 69
 ovenproof 69
 over 320
 over par 233
 overalls 82
 overdraft 96
 overexposed 271
 overflow pipe 61
 overhead locker 210
 overhead projector 163
 overtake v 195

- overture 256
 ovulation 20, 52
 owl 292
 oyster 121
 ozone layer 286
- P**
 Pacific Ocean 312
 pack 311
 pack of cards 273
 packet 311
 packet of cigarettes 112
 pad 224
 paddle 241
 paddling pool 263
 paddock 242
 pads 53, 220
 paediatrics 49
 painkiller 109
 painkillers 47
 paint 83
 paint v 83
 paint tin 83
 paint tray 83
 painter 191
 painting 62, 261, 274
 paints 274
 pak-choi 123
 Pakistan 318
 palate 19
 palette 274
 pallet 186
 palm 15, 86, 296
 palm hearts 122
 palmtop 175
 pan 310
 pan fried 159
 Panama 314
 pancakes 157
 pancreas 18
 panda 291
 panty liner 108
 papaya 128
 paper clip 173
 paper guide 172
 paper napkin 154
 paper tray 172
 papier-mâché 275
 paprika 132
 Papua New Guinea 319
 par 233
 parachute 248
 parachuting 248
 paragliding 248
 Paraguay 315
 parallel 165
 parallel bars 235
 parallelogram 164
 paramedic 94
 parcel 99
 parents 23
 park 262
 park v 195
 parking meter 195
 parmesan 142
 parole 181
 parrot 293
 parsley 133
- parsnip 125
 partner 23
 pass 226
 pass v 220, 223
 passenger 216
 passenger port 216
 passion fruit 128
 Passover 27
 passport 213
 passport control 213
 pasta 158
 pastels 274
 pasteurized 137
 pasting brush 82
 pasting table 82
 pastry 140, 149
 pastry brush 69
 pasture 182
 patch 207
 patchwork 277
 pâté 142, 156
 path 58, 85
 pathology 49
 patient 45
 patio garden 85
 pattern 276
 pause 269
 pavement 298
 pavement café 148
 paving 85
 pawn 272
 pay v 153
 pay in v 96
 pay per view channel 269
 paying-in slips 96
 payment 96
 payroll 175
 peach 126, 128
 peacock 293
 peanut 129
 peanut butter 135
 peanuts 151
 pear 127
 peas 131
 pecan 129
 pectoral 16
 pectoral fin 294
 pedal 61, 206
 pedal v 207
 pedestrian crossing 195
 pedestrian zone 299
 pedicure 41
 pediment 301
 peel v 67
 peeled prawns 120
 peeler 68
 pelican 292
 pelvis 17
 pen 163, 185
 penalty 222
 penalty area 223
 pencil 163, 275
 pencil case 163
 pencil sharpener 163
 pendant 36
 penfriend 24
 penguin 292
 peninsula 282
- penis 21
 pentagon 164
 peony 111
 people 12, 16
 people carrier 199
 pepper 64, 124, 152
 peppercorn 132
 pepperoni 142
 percentage 165
 percussion 257
 perennial 86
 perfume 41
 perfumery 105
 pergola 84
 periodical 168
 perm 39
 perpendicular 165
 persimmon 128
 personal best 234
 personal CD player 269
 personal organizer 173, 175
 personal trainer 250
 personnel department 175
 Peru 315
 pesticide 89, 183
 pestle 68, 167
 pet food 107
 pet shop 115
 petal 297
 petri dish 166
 petrol 199
 petrol pump 199
 petrol station 199
 petrol tank 203
 pharmacist 108, 189
 pharynx 19
 pheasant 119, 293
 Phillips screwdriver 81
 philosophy 169
 Philippines 319
 photo album 271
 photo finish 234
 photo frame 271
 photofit 181
 photographer 191
 photograph 271
 photograph v 271
 photography 270
 physical education 162
 physics 162, 169
 physiotherapy 49
 piano 256
 piccolo 257
 pick v 91
 pick and mix 113
 pickaxe 187
 pickled 159
 pickup 258
 picnic 263
 picnic bench 266
 pie 158
 pie tin 69
 piece 272
 pier 217
 pies 143
 pig 185
 pig farm 183
 pigeon 292
- pigeonhole 100
 piglet 185
 pigsty 185
 pigtailed 39
 Pilates 251
 pill 21, 109
 pillar 300
 pillion 204
 pillow 70
 pillowcase 71
 pilot 190, 211
 pin 60, 237, 249, 276
 pin number 96
 pincushion 276
 pine 296
 pine nut 129
 pineapple 128
 pineapple juice 149
 pink 274
 pint 311
 pinto beans 131
 pip 128
 pipe 112, 202
 pipe cutter 81
 pipette 167
 piping bag 69
 pistachio 129
 pitch 225, 256, 266
 pitch v 229
 pitch a tent v 266
 pitcher 151, 229
 pitcher's mound 228
 pitches available 266
 pith 126
 pitta bread 139
 pizza 154
 pizza parlour 154
 place mat 64
 place setting 65
 placenta 52
 plain 285
 plain chocolate 113
 plain flour 139
 plait 39
 plane 81
 plane v 79
 planet 280, 282
 plant v 183
 plant pot 89
 plants 86, 296
 plaque 50
 plaster 47, 83
 plaster v 82
 plastic bag 122
 plastic pants 30
 plastic surgery 49
 plate 65, 283
 plateau 284
 platform 208
 platform number 208
 platform shoe 37
 platinum 289
 play 254, 269
 play v 229, 273
 player 221, 231, 273
 playground 263
 playhouse 75
 playing 75
- playpen 75
 plea 180
 please 322
 Plimsoll line 214
 plough v 183
 plug 60, 72
 plum 126
 plumb line 82
 plumber 188
 plumbing 61
 plunger 81
 plus 165
 Pluto 280
 plywood 79
 pneumatic drill 187
 poach v 67
 poached 159
 pocket 32
 pod 122
 podium 235, 256
 point 273
 poisoning 46
 poker 273
 Poland 316
 polar bear 291
 pole 245, 282
 pole vault 234
 police 94
 police car 94
 police cell 94
 police officer 94
 police station 94
 policeman 189
 polish 77
 polish v 77
 politics 169
 polo 243
 polyester 277
 pomegranate 128
 pommel 242
 pommel horse 235
 pond 85
 ponytail 39
 pool 249
 pop 259
 popcorn 255
 poplar 296
 popper 30
 poppy 297
 poppy seeds 138
 porch 58
 porch light 58
 pore 15
 pork 118
 porridge 156
 port 145, 176, 214, 216
 porter 100
 portfolio 97
 porthole 214
 portion 64
 portrait 271
 Portugal 316
 positive electrode 167
 post office 98
 postage 98
 postal code 98
 postal order 98
 postal worker 98

- postbox 99
 postcard 112
 poster 255
 poster paint 274
 postgraduate 169
 postman 98, 190
 postmark 98
 pot plant 110
 pot up v 91
 potato 124
 pot-pourri 111
 potted plant 87
 potter's wheel 275
 pottery 275
 potty 74
 pouch 291
 poultry 119
 poultry farm 183
 pound 310
 pour v 67
 powder 77, 109
 powder puff 40
 powdered milk 137
 power 60
 power cable 176
 power cut 60
 practice swing 233
 pram 75
 praying mantis 295
 pregnancy 52
 pregnancy test 52
 pregnant 52
 premature 52
 premolar 50
 pre-recorded 178
 prescription 45
 present 27
 presentation 174
 presenter 178
 preservative 83
 preserved fruit 134
 press 178
 presser foot 276
 press-up 251
 pressure valve 61
 price 152, 199
 price list 154
 prickly pear 128
 primer 83
 primrose 297
 principality 315
 print 271
 print v 172
 printer 172, 176
 printing 275
 prison 181
 prison guard 181
 private bathroom 100
 private jet 211
 private room 48
 probe 50
 problems 271
 processed grains 130
 procession 27
 processor 176
 producer 254
 program 176
 programme 254, 269
- programming 178
 projector 174
 promenade 265
 propagate v 91
 propeller 211, 214
 proposal 174
 prosciutto 143
 prosecution 180
 prostate 21
 protractor 165
 proud 25
 prove v 139
 province 315
 prow 215
 prune 129
 prune v 91
 psychiatry 49
 psychotherapy 55
 public address system 209
 puck 224
 pudding rice 130
 Puerto Rico 314
 puff pastry 140
 pull up v 251
 pulp 127
 pulse 47
 pulses 130
 pumice 288
 pumice stone 73
 pump 207
 pumpkin 125
 pumpkin seed 131
 punch 237
 punch bag 237
 puncture 203, 207
 pup 290
 pupil 51, 162
 puppy 290
 purple 274
 purse 37
 pushchair 75
 putt v 233
 putter 233
 pyjamas 33
 pyramid 164
- Q**
 Qatar 318
 quadriceps 16
 quail 119
 quail egg 137
 quart 311
 quarter of an hour 304
 quarterdeck 214
 quartz 289
 quay 216
 queen 272, 273
 question 163
 question v 163
 quilt 71
 quilting 277
 quince 128
 quinoa 130
 quiver 249
- R**
 rabbit 118, 290
 raccoon 290
 race 234
 racecourse 243
 racehorse 243
 racing bike 205, 206
 racing dive 239
 racing driver 249
 rack 166
 racquet 230
 racquet games 231
 racquetball 231
 radar 214, 281
 radiator 60, 202
 radicchio 123
 radio 179, 268
 radio antenna 214
 radio station 179
 radiology 49
 radish 124
 radius 17, 164
 rafter 186
 rafting 241
 rail 208
 rail network 209
 rain 287
 rainbow 287
 rainbow trout 120
 raincoat 31, 32
 rainforest 285
 raisin 129
 rake 88
 rake v 90
 rally 230
 rally driving 249
 RAM 176
 Ramadan 26
 ramekin 69
 rap 259
 rapeseed 184
 rapeseed oil 135
 rapids 240, 284
 rash 44
 rasher 119
 raspberry 127
 raspberry jam 134
 rat 290
 rattle 74
 raw 124, 129
 ray 294
 razor blade 73
 razor-shell 121
 read v 162
 reading light 210
 reading list 168
 reading room 168
 reamer 80
 rear light 207
 rear wheel 197
 rearview mirror 198
 receipt 152
 receive v 177
 receiver 99
 reception 100
 receptionist 100, 190
 rechargeable drill 78
 record 234, 269
 record player 268
 record shop 115
 recording studio 179
- rectangle 164
 rectum 21
 recycling bin 61
 red 145, 274
 red card 223
 red eye 271
 red kidney beans 131
 red lentils 131
 red meat 118
 red mullet 120
 Red Sea 313
 reduce v 172
 reel 244
 reel in v 245
 refectory 168
 referee 222, 226
 referral 49
 reflector 50, 204, 207
 reflector strap 205
 reflexology 54
 refrigerator 67
 reggae 259
 region 315
 register 100
 registered post 98
 regulator 239
 re-heat v 154
 reiki 55
 reins 242
 relationships 24
 relatives 23
 relaxation 55
 relay race 235
 release v 245
 remote control 269
 Renaissance 301
 renew v 168
 rent 58
 rent v 58
 repair kit 207
 report 174
 reporter 179
 reproduction 20
 reproductive 19
 reproductive organs 20
 reptiles 293
 research 169
 reserve v 168
 respiratory 19
 rest 256
 restaurant 101, 152
 result 49
 resurfacing 187
 resuscitation 47
 retina 51
 retire v 26
 return 231
 return address 98
 return date 168
 rev counter 201
 reverse v 195
 reverse charge call 99
 rewind 269
 rhinoceros 291
 rhombus 164
 rhubarb 127
 rhythmic gymnastics 235
 rib 17, 119
- rib cage 17
 ribbon 27
 ribbon 39, 111, 141, 235
 ribs 155
 rice 130, 158, 184
 rice pudding 140
 rider 242
 riding boot 242
 riding crop 242
 riding hat 242
 rigging 215, 240
 right 260
 right field 229
 right-hand drive 201
 rim 206
 rind 119, 127, 136, 142
 ring 36
 ring finger 15
 ring ties 89
 rings 235
 rinse v 38, 76
 riol 129
 rise v 139
 river 284
 road bike 206
 road markings 194
 road signs 195
 roads 194
 roadworks 187, 195
 roast 158
 roast v 67
 roasted 129
 robe 38, 169
 rock climbing 248
 rock concert 258
 rock garden 84
 rocket 123
 rocks 284, 288
 Rocky Mountains 312
 rococo 301
 rodeo 243
 roll 139, 311
 roll v 67
 roller 83, 187
 roller blind 63
 roller coaster 262
 roller skating 249
 rollerblading 263
 rollerskate 249
 rolling pin 69
 romance 255
 Romania 316
 romper suit 30
 roof 58, 203
 roof garden 84
 roof tile 187
 roofrack 198
 rook 272
 room 58
 room key 100
 room number 100
 room service 101
 rooms 100
 root 50, 124, 296
 roots 39
 rope 248
 rose 89, 110, 145
 rosé 145

- rosemary 133
 rotor blade 211
 rotten 127
 rough 232
 round 237
 round neck 33
 roundabout 195
 route number 196
 router 78
 row 210, 254
 row v 241
 rower 241
 rowing boat 214
 rowing machine 250
 rubber 163
 rubber band 173
 rubber boots 89
 rubber ring 265
 rubber stamp 173
 rubbish bin 61, 67
 ruby 288
 ruck 221
 rudder 210, 241
 rug 63
 rugby 221
 rugby pitch 221
 rugby strip 221
 ruler 163, 165
 rum 145
 rum and coke 151
 rump steak 119
 run 228
 run v 228
 runner bean 122
 runway 212
 rush 86
 rush hour 209
 Russian Federation 318
 Rwanda 317
 rye bread 138
- S**
 sad 25
 saddle 206, 242
 safari park 262
 safe 228
 safety 75, 240
 safety barrier 246
 safety goggles 81, 167
 safety pin 47
 saffron 132
 sage 133
 Sahara Desert 313
 sail 241
 sailboat 215
 sailing 240
 sailor 189
 salad 149
 salamander 294
 salami 142
 salary 175
 sales assistant 104
 sales department 175
 salmon 120
 saloon 199
 salt 64, 152
 salted 121, 129, 137, 143
 San Marino 316
- sand 85, 264
 sand v 82
 sandal 37
 sandals 31
 sandcastle 265
 sander 78
 sandpaper 81, 83
 sandpit 263
 sandstone 288
 sandwich 155
 sandwich counter 143
 sanitary towel 108
 São Tomé and Príncipe 317
 sapphire 288
 sardine 120
 Sardinia 316
 satellite 281
 satellite dish 269
 satellite navigation 201
 satsuma 126
 Saturday 306
 Saturn 280
 sauce 134, 143, 155
 saucepan 69
 Saudi Arabia 318
 sauna 250
 sausage 155, 157
 sausages 118
 sauté v 67
 save v 177, 223
 savings 96
 savings account 97
 savoury 155
 saw v 79
 saxophone 257
 scaffolding 186
 scale 121, 256, 294
 scales 45, 53, 69, 98, 118,
 166, 212, 293, 310
 scallop 121
 scalp 39
 scalpel 81, 167
 scan 48, 52
 scanner 106, 176
 scarecrow 184
 scared 25
 scarf 31, 36
 schist 288
 scholarship 169
 school 162, 299
 school bag 162
 school bus 196
 school uniform 162
 schoolboy 162
 schoolgirl 162
 schools 169
 science 162, 166
 science fiction film 255
 scientist 190
 scissors 38, 47, 82, 188, 276
 scoop 68, 149
 scooter 205
 score 220, 256, 273
 score a goal v 223
 scoreboard 225
 scorpion 295
 scotch and water 151
 scrabble 272
- scrambled eggs 157
 scrape v 77
 scraper 82
 screen 59, 63, 97, 176, 255,
 269
 screen wash 199
 screen wash reservoir 202
 screw 80
 screwdriver 80
 screwdriver bits 80
 script 254
 scrollbar 177
 scrotum 21
 scrub v 77
 scrum 221
 scuba diving 239
 sculpting 275
 sculptor 191
 sea 264, 282
 sea bass 120
 sea bream 120
 sea horse 294
 sea lion 290
 sea plane 211
 seafood 121
 seal 290
 sealant 83
 sealed jar 135
 seam 34
 seamstress 191
 search v 177
 seasonal 129
 seasons 306
 seat 61, 204, 209, 210, 242,
 254
 seat back 210
 seat belt 198, 211
 seat post 206
 seating 254
 secateurs 89
 second 304, 309
 second floor 104
 second hand 304
 second-hand shop 115
 section 282
 security 212
 security bit 80
 security guard 189
 sedative 109
 sedimentary 288
 seed 122, 127, 130
 seed tray 89
 seeded bread 139
 seedless 127
 seedling 91
 seeds 88, 131
 seesaw 263
 segment 126
 self defence 237
 self-raising flour 139
 self-tanning cream 41
 semidetached 58
 semi-hard cheese 136
 seminal vesicle 21
 semi-skimmed milk 136
 semi-soft cheese 136
 semolina 130
 send v 177
- send off 223
 Senegal 317
 sensitive 41
 sentence 181
 September 306
 serve 231
 serve v 64, 231
 server 176
 service included 152
 service line 230
 service not included 152
 service provider 177
 service vehicle 212
 serving spoon 68
 sesame seed 131
 sesame seed oil 134
 set 178, 230, 254
 set v 38
 set honey 134
 set sail v 217
 set square 165
 set the alarm v 71
 seven 308
 seven hundred 308
 seventeen 308
 seventeenth 309
 seventh 309
 seventieth 309
 seventy 308
 sew v 277
 sewing basket 276
 sewing machine 276
 sexually transmitted disease
 20
 shade 41
 shade plant 87
 shallot 125
 shallow end 239
 shampoo 38
 shapes 164
 share price 97
 shares 97
 shark 294
 sharp 256
 sharpening stone 81
 shaving 73
 shaving foam 73
 shears 89
 shed 84
 sheep 185
 sheep farm 183
 sheep's milk 137
 sheet 71, 74, 241
 shelf 67, 106
 shell 129, 137, 265, 293
 shelled 129
 shelves 66
 sherry 145
 shiatsu 54
 shield 88
 shin 12
 ship 214
 ships 215
 shipyard 217
 shirt 32
 shock 47
 shocked 25
 shoe department 104
- shoe shop 114
 shoes 34, 37
 shoot v 223, 227
 shop 298
 shop assistant 188
 shopping 104
 shopping bag 106
 shopping centre 104
 shops 114
 short 32, 321
 short sight 51
 short wave 179
 short-grain 130
 shorts 30, 33
 shot 151
 shotput 234
 shoulder 13
 shoulder bag 37
 shoulder blade 17
 shoulder pad 35
 shoulder strap 37
 shout v 25
 shovel 187
 shower 72, 286
 shower block 266
 shower curtain 72
 shower door 72
 shower gel 73
 shower head 72
 showjumping 243
 shuffle v 273
 shutoff valve 61
 shutter 58
 shutter release 270
 shutter-speed dial 270
 shuttle bus 197
 shuttlecock 231
 shy 25
 Siberia 313
 Sicily 316
 side 164
 sideline 220
 side order 153
 side plate 65
 side saddle 242
 side street 299
 sidedeck 240
 side-effects 109
 sideline 226, 230
 Sierra Leone 317
 sieve 68, 89
 sieve v 91
 sift v 138
 sigh v 25
 sightseeing 260
 sign 104
 signal 209
 signature 96, 98
 silencer 203, 204
 silk 277
 silo 183
 silt 85
 silver 235, 289
 simmer v 67
 Singapore 319
 singer 191
 single 151

- single bed 71
 single cream 137
 single room 100
 singles 230
 sink 38, 61, 66
 sinus 19
 siren 94
 sirloin steak 119
 sister 22
 sister-in-law 23
 site manager's office 266
 sit-up 251
 six 308
 six hundred 308
 sixteen 308
 sixteenth 309
 sixth 309
 sixtieth 309
 sixty 308
 skate 120, 247, 294
 skate v 224
 skate wings 120
 skateboard 249
 skateboarding 249, 263
 skein 277
 skeleton 17
 sketch 275
 sketch pad 275
 skewer 68
 ski 241, 246
 ski boot 246
 ski jump 247
 ski pole 246
 ski run 246
 ski slope 246
 ski suit 246
 skier 246
 skiing 246
 skimmed milk 136
 skin 14, 119, 128
 skin care 108
 skinned 121
 skipping 251
 skirt 30, 34
 skull 17
 skydiving 248
 skyscraper 299, 300
 slalom 247
 slate 288
 sledding 247
 sledgehammer 187
 sleeping 74
 sleeping bag 267
 sleeping compartment 209
 sleeping mat 267
 sleeping pill 109
 sleepsuit 30
 sleet 286
 sleeve 34
 sleeveless 34
 slice 119, 139, 140, 230
 slice v 67
 sliced bread 138
 slicer 139
 slide 167, 263
 slide v 229
 sling 46
 slip 35
 slip road 194
 slip-on 37
 slippers 31
 slope 284
 slotted spoon 68
 Slovakia 316
 Slovenia 316
 slow 321
 slug 295
 small 321
 small car 199
 small intestine 18
 small of back 13
 smash 231
 smile 25
 smoke 95
 smoke alarm 95
 smoked 118, 121, 143, 159
 smoked fish 143
 smoking 112
 smoking section 152
 snack bar 113, 148
 snail 295
 snake 293
 snare drum 257
 sneeze 44
 snooker 249
 snore v 71
 snorkel 239
 snout 293
 snow 287
 snowboarding 247
 snowmobile 247
 snowsuit 30
 soak v 130
 soap 73, 178
 soap dish 73
 soccer 222
 socket 60, 80
 socket wrench 80
 socks 33
 soda bread 139
 soda water 144
 sofa 62
 sofabed 63
 soft 129, 321
 soft cheese 136
 soft drink 154
 soft drinks 144
 soft toy 75
 software 176
 softwood 79
 soil 85
 solar system 280
 solder 79, 80
 solder v 79
 soldering iron 81
 soldier 189
 sole 15, 37
 solids 164
 Solomon Islands 319
 soluble 109
 solvent 83
 Somalia 317
 somersault 235
 son 22
 sonata 256
 song 259
 son-in-law 22
 sorbet 141
 sorrel 123
 sorting unit 61
 soufflé 158
 soufflé dish 69
 sound boom 179
 sound technician 179
 soundtrack 255
 soup 153, 158
 soup bowl 65
 soup spoon 65
 sour 127
 sour cream 137
 sourdough bread 139
 south 312
 South Africa 317
 South Korea 318
 southern hemisphere 283
 Southern Ocean 313
 souvenirs 260
 sow v 90, 183
 soya beans 131
 space 280
 space exploration 281
 space shuttle 281
 space station 281
 space suit 281
 spade 88, 265, 273
 Spain 316
 spanner 80
 spare tyre 203
 spark plug 203
 sparkling 144
 sparring 237
 sparrow 292
 spatula 68, 167
 speaker 174, 176, 258, 268
 speaker stand 268
 spearfishing 245
 specials 152
 spectators 233
 speed boating 241
 speed limit 195
 speed skating 247
 speedboat 214
 speedometer 201, 204
 spell v 162
 sperm 20
 sphere 164
 spices 132
 spicy sausage 142
 spider 295
 spike v 90
 spikes 233
 spin 230
 spin v 76
 spin dryer 76
 spinach 123
 spine 17
 spire 300
 spirit level 80, 187
 splashback 66
 spleen 18
 splint 47
 splinter 46
 split ends 39
 split peas 131
 spoke 207
 sponge 73, 74, 83
 sponge cake 140
 sponge fingers 141
 spool 245
 spoon 65
 sport fishing 245
 sports 105, 220, 236, 248
 sports car 198
 sports field 168
 sports jacket 33
 sportsman 191
 spotlight 259
 sprain 46
 spray 109
 spray v 91
 spray can 311
 spray gun 89
 spring 71, 307
 spring balance 166
 spring greens 123
 spring onion 125
 springboard 235, 238
 sprinkler 89
 sprinter 234
 sprocket 207
 square 164, 272, 299
 square foot 310
 square metre 310
 squash 231
 squat 251
 squid 121, 295
 squirrel 290
 Sri Lanka 318
 St Kitts and Nevis 314
 St Lucia 314
 St Vincent and the
 Grenadines 314
 stabilisers 207
 stable 185, 243
 stadium 223
 staff 175, 256
 stage 167, 254
 stages 23
 stainless steel 79
 stair gate 75
 staircase 59
 stake 90
 stake v 91
 stalk 122, 297
 stalls 254
 stamen 297
 stamp 98
 stamp collecting 273
 stamps 112
 stance 232
 stand 88, 205, 268
 stapler 173
 staples 173
 star 280
 star anise 133
 starfish 295
 starfruit 128
 start school v 26
 starter 153
 starting block 234, 238
 starting line 234
 state 315
 statement 180
 stationery 105
 statuette 260
 steak 121
 steam v 67
 steam train 208
 steamed 159
 steeplechase 243
 steering wheel 201
 stem 111, 112, 297
 stencil 83
 stenographer 181
 step machine 250
 stepdaughter 23
 stepfather 23
 stepladder 82
 stepmother 23
 stepson 23
 stereo 269
 sterile 47
 stern 240
 stethoscope 45
 stew 158
 stick 224, 249
 sticks 133
 sticky tape 173
 still 144
 sting 46, 295
 stir v 67
 stir fry 158
 stirrer 150
 stirrup 242
 stitch 277
 stitch selector 276
 stitches 52
 stock broker 97
 stock exchange 97
 stockings 35
 stocks 97, 110
 stomach 18
 stomach ache 44
 stone 36, 275
 stoned fruit 126
 stop 269
 stop button 197
 stopper 166
 stopwatch 234
 store directory 104
 stork 292
 storm 287
 stout 145
 stamen 297
 straight 39, 165
 straight on 260
 straighten v 39
 strap 35
 strapless 34
 stratosphere 286
 straw 144, 154
 strawberry 127
 strawberry milkshake 149
 stream 285
 street 298
 street corner 298
 street light 298
 street sign 298
 street stall 154
 stress 55
 stretch 251

- stretcher 94
 strike 228, 237
 string 230, 258
 string of pearls 36
 strings 256
 strip v 82
 stroke 44, 233, 239
 strokes 231
 strong 321
 strong flour 139
 stub 96
 study 63, 162
 stuffed 159
 stuffed olive 143
 stump 225
 styles 39, 239, 301
 submarine 215
 subsoil 91
 substitute 223
 substitution 223
 subtract v 165
 suburb 299
 succulent 87
 suction hose 77
 Sudan 317
 sugarcane 184
 suit 273
 sulphur 289
 sultana 129
 summer 31, 307
 summons 180
 sumo wrestling 237
 Sun 280
 sunbathe v 264
 sunbed 41
 sunblock 108, 265
 sunburn 46
 Sunday 306
 sunflower 184, 297
 sunflower oil 134
 sunflower seed 131
 sunglasses 51, 265
 sunhat 30, 265
 sunny 286
 sunrise 305
 sunroof 202
 sunscreen 108
 sunset 305
 sunshine 286
 suntan lotion 265
 supermarket 106
 supersonic jet 211
 supplement 55
 supply pipe 61
 support 187
 suppository 109
 surf 241
 surfboard 241
 surfcasting 245
 surfer 241
 surfing 241
 surgeon 48
 surgery 45, 48
 Suriname 315
 surprised 25
 suspect 94, 181
 suspenders 35
 suspension 203, 205
- swallow 292
 swamp 285
 swan 293
 Swaziland 317
 sweater 33
 sweatpants 33
 sweatshirt 33
 sweede 125
 Sweden 316
 sweep v 77
 sweet 124, 127, 155
 sweet potato 125
 sweet shop 113
 sweet spreads 134
 sweet trolley 152
 sweetcorn 122
 sweets 113
 swim v 238
 swimmer 238
 swimming 238
 swimming pool 101, 238, 250
 swimsuit 238, 265
 swing v 232
 swings 263
 swiss chard 123
 switch 60
 Switzerland 316
 swivel chair 172
 sword 236
 swordfish 120, 294
 symphony 256
 synagogue 300
 synchronized swimming 239
 synthetic 31
 Syria 318
 syringe 109, 167
 syrup 109
 system 176
- T**
 tab 173
 table 64, 148
 table tennis 231
 tablecloth 64
 tack v 241, 277
 tackle 245
 tackle v 220, 223
 tackle box 244
 tadpole 294
 tae-kwon-do 236
 tag v 229
 tai chi 236
 tail 121, 210, 242, 280, 290, 294
 tail light 204
 tailbone 17
 tailgate 198
 tailor 191
 tailored 35
 tailor's 115
 tailor's chalk 276
 tailor's dummy 276
 tailplane 210
 Tajikistan 318
 take a bath v 72
 take a shower v 72
 take notes v 163
- take off v 211
 take-away 154
 talcum powder 73
 tall 321
 tambourine 257
 tampon 108
 tan 41
 tandem 206
 tangerine 126
 tank 61
 Tanzania 317
 tap 61, 66
 tap water 144
 tape dispenser 173
 tape measure 80, 276
 target 249
 target shooting 249
 tarmac 187
 taro root 124
 tarragon 133
 Tasmania 319
 tattoo 41
 tax 96
 taxi driver 190
 taxi rank 213
 tea 144, 149, 184
 tea with lemon 149
 tea with milk 149
 teabag 144
 teacher 54, 162, 191
 teacup 65
 team 220, 229
 teapot 65
 tear 51
 teaspoon 65
 teat 75
 techniques 79, 159
 teddy bear 75
 tee 233
 teeing ground 232
 teenager 23
 tee-off v 233
 telegram 98
 telephone 99, 172
 telephone box 99
 telescope 281
 television series 178
 television studio 178
 temperature 286
 temperature gauge 201
 temple 14, 300
 ten 308
 ten thousand 309
 tenant 58
 tend v 91
 tendon 17
 tennis 230
 tennis court 230
 tennis shoes 231
 tenon saw 81
 tent 267
 tent peg 266
 tent pole 266
 tenth 309
 tequila 145
 terminal 212
 termite 295
 terrace café 148
- terraced 58
 territory 315
 terry nappy 30
 test 49
 test tube 166
 testicle 21
 text message 99
 textbook 163
 Thailand 318
 thank you 322
 Thanksgiving 27
 the day after tomorrow 307
 the day before yesterday 307
 theatre 254, 299
 theme park 262
 therapist 55
 thermals 267
 thermometer 45, 167
 thermosphere 286
 thermostat 61
 thesis 169
 thick 321
 thigh 12, 119
 thimble 276
 thin 321
 third 309
 thirteen 308
 thirteenth 309
 thirtieth 309
 thirty 308
 this way up 98
 this week 307
 thistle 297
 thoracic vertebrae 17
 thread 276
 thread v 277
 thread guide 276
 thread reel 276
 three 308
 three hundred 308
 three-door 200
 three-point line 226
 thriller 255
 throat 19
 throat lozenge 109
 throttle 204
 through 320
 throw 237
 throw v 221, 227, 229
 throw-in 223, 226
 thruster 281
 thumb 15
 thunder 286
 Thursday 306
 thyme 133
 thyroid gland 18
 tibia 17
 ticket 209, 213
 ticket barrier 209
 ticket inspector 209
 ticket office 209, 216
 tie 32
 tiebreak 230
 tie-pin 36
 tiger 291
 tights 35, 251
 tile 58, 272
 tile v 82
- till 106, 150
 tiller 240
 timber 187
 time 234, 304
 time out 220
 timer 166
 times 165, 261
 timetable 197, 209, 261
 timing 203
 tin 289, 311
 tinned food 107
 tip 36, 122, 246
 tissue 108
 title 168
 titles 23
 to 320
 toad 294
 toast 157
 toasted sandwich 149
 toaster 66
 tobacco 112, 184
 today 306
 toddler 30
 toe 15
 toe clip 207
 toe strap 207
 toenail 15
 toffee 113
 toggle 31
 Togo 317
 toilet 72
 toilet brush 72
 toilet roll 72
 toilet seat 72
 toiletries 41, 107
 toilets 104, 266
 toll booth 194
 tomato 125, 157
 tomato juice 144, 149
 tomato sauce 154
 tomorrow 306
 toner 41
 tongs 150, 167
 tongue 19, 37, 118
 tonic water 144
 tonne 310
 tool rack 78
 toolbar 177
 toolbelt 186
 toolbox 80
 tools 187
 tooth 50
 toothache 50
 toothbrush 72
 toothpaste 72
 top coat 83
 top dress v 90
 top tier 141
 topaz 288
 topiary 87
 topping 155
 topsoil 85
 torch 267
 tornado 287
 tortoise 293
 touch line 221
 touchdown 221
 tour bus 260

- tour guide 260
 tourer 205
 touring bike 206
 tourist 260
 tourist attraction 260
 tourist bus 197
 tourist information 261
 tourmaline 288
 tournament 233
 tow away v 195
 tow truck 203
 towards 320
 towel rail 72
 towels 73
 tower 300
 town 298
 town hall 299
 townhouse 58
 toy 75
 toy basket 75
 toys 105
 track 208, 234
 tracksuit 31, 32
 tractor 182
 traffic 194
 traffic jam 195
 traffic light 194
 traffic policeman 195
 trailer 266
 train 35, 208
 train v 91, 251
 train station 208
 trainer 37
 trainers 31, 251
 tram 196, 208
 transfer 223
 transformer 60
 transmission 202
 transplant v 91
 transport 194
 trapezium 164
 trapezoid 164
 trash 177
 travel agent 190
 travel agent's 114
 travel sickness pills 109
 traveller's cheque 97
 tray 152, 154
 tray-table 210
 tread 207
 tread water v 239
 treadmill 250
 treble clef 256
 tree 86, 296
 trekking 243
 trellis 84
 tremor 283
 triangle 164, 257
 triceps 16
 trifle 141
 trim v 39, 90
 trimester 52
 trimmer 88
 Trinidad and Tobago 314
 tripod 166, 270, 281
 trolley 48, 100, 106, 208, 213
 trolley bus 196
- trombone 257
 tropic of Cancer 283
 tropic of Capricorn 283
 tropical fruit 128
 tropics 283
 troposphere 286
 trot 243
 trough 183
 trousers 32, 34
 trout 120
 trowel 89, 187
 truffle 113, 125
 trug 88
 trumpet 257
 truncheon 94
 trunk 291, 296
 trunks 238
 try 221
 t-shirt 30, 33
 tub 311
 tuba 257
 tube 311
 Tuesday 306
 tug boat 215
 tulip 111
 tumble 235
 tumble dryer 76
 tumbler 65
 tuna 120
 tune v 179
 tune the radio v 269
 tuning peg 258
 Tunisia 317
 turbocharger 203
 turf v 90
 Turkey 316
 turkey 119, 185, 293
 Turkmenistan 318
 turmeric 132
 turn 238
 turn v 79
 turn the television off v 269
 turn the television on v 269
 turnip 124
 turpentine 83
 turquoise 289
 turret 300
 turtle 293
 tusk 291
 tutu 191
 tweezers 40, 47, 167
 twelfth 309
 twelve 308
 twentieth 309
 twenty 308
 twenty minutes 304
 twenty thousand 309
 twenty-first 309
 twenty-one 308
 twenty-second 309
 twenty-third 309
 twenty-two 308
 twig 296
 twin room 100
 twine 89
 twins 23
 twist ties 89
 two 308
- two hundred 308
 two o'clock 304
 two thousand 307
 two thousand and one 307
 two-door 200
 types 199, 205
 types of buses 196
 types of camera 270
 types of farm 183
 types of plants 86
 types of fishing 245
 types of train 208
 tyre 198, 205, 206
 tyre lever 207
 tyre pressure 203
- U**
 Uganda 317
 ugli 126
 Ukraine 316
 ulna 17
 ultrasound 52
 ultraviolet rays 286
 umbilical cord 52
 umbrella 36, 233
 umpire 225, 229, 230
 uncle 22
 unconscious 47
 uncooked meat 142
 under 320
 under par 233
 undercoat 83
 underexposed 271
 undergraduate 169
 underground map 209
 underground train 209
 underpass 194
 underwear 32, 35
 underwired 35
 uniform 94, 189
 United Arab Emirates 318
 United Kingdom 316
 United States of America 314
 universe 280
 university 299
 unleaded 199
 unpasteurised 137
 unpick v 277
 unsalted 137
 until 320
 up 320
 upper circle 254
 upset 25
 Uranus 280
 ureter 21
 urethra 20
 urinary 19
 urology 49
 Uruguay 315
 usher 255
 uterus 20, 52
 utility room 76
 Uzbekistan 318
- V**
 vacuum cleaner 77, 188
 vacuum flask 267
 vagina 20
- valance 71
 valley 284
 valve 207
 vanilla 132
 Vanuatu 319
 varnish 79, 83
 vas deferens 21
 vase 63, 111
 Vatican City 316
 vault 235, 300
 veal 118
 vegetable garden 85
 vegetable oil 135
 vegetable plot 182
 vegetables 107, 122, 124
 veggie burger 155
 veil 35
 vein 19
 venetian blind 63
 Venezuela 315
 venison 118
 vent 283
 ventouse cup 53
 Venus 280
 verdict 181
 vest 33, 35, 251
 vet 189
 vibraphone 257
 vice 78
 video game 269
 video phone 99
 video recorder 269
 video tape 269
 Viet Nam 318
 viewfinder 271
 village 299
 vine 183
 vinegar 135, 142
 vineyard 183
 vintage 199
 viola 256
 violin 256
 virus 44
 visa 213
 vision 51
 visiting hours 48
 visor 205
 vitamins 108
 v-neck 33
 vocal cords 19
 vodka 145
 vodka and orange 151
 voice message 99
 volcano 283
 volley 231
 volleyball 227
 voltage 60
 volume 165, 179, 269, 311
 vomit v 44
- W**
 waders 244
 waffles 157
 waist 12
 waistband 35
 waistcoat 33
 waiter 148, 152
 waiting room 45
- waitress 191
 wake up v 71
 walk 243
 walking boot 37
 walking boots 267
 walkway 212
 wall 58, 186, 222
 wall light 62
 wallet 37
 wallpaper 82, 177
 wallpaper v 82
 wallpaper brush 82
 wallpaper paste 82
 walnut 129
 walnuts 107, 122, 124
 walrus 290
 ward 48
 wardrobe 70
 warehouse 216
 warm 286
 warm up v 251
 warrant 180
 wash v 38, 77
 washbasin 72
 washer 80
 washer-dryer 76
 washing machine 76
 wasp 295
 waste disposal 61, 266
 waste disposal unit 61
 waste pipe 61
 wastebasket 172
 watch 36
 watch television v 269
 water 144, 238
 water v 90, 183
 water bottle 206, 267
 water chamber 61
 water chestnut 124
 water closet 61
 water garden 84
 water hazard 232
 water jet 95
 water plant 86
 water polo 239
 watercolour paints 274
 watercress 123
 waterfall 285
 watering 89
 watering can 89
 watermelon 127
 waterproofs 245, 267
 waterskier 241
 waterskiing 241
 watersports 241
 wave 241, 264
 wavelength 179
 wax 41
 weak 321
 weather 286
 weaving 277
 website 177
 wedding 26, 35
 wedding cake 141
 wedding dress 35
 wedding reception 26
 wedge 233
 Wednesday 306

weed v 91
 weed killer 91
 weeds 86
 week 306
 weekend 306
 weekly 307
 weigh v 310
 weight 166, 244
 weight bar 251
 weight belt 239
 weight training 251
 wellington boots 31
 west 312
 western 255
 Western sahara 317
 wet 286, 321
 wet wipe 75, 108
 wetsuit 239
 whale 290
 wheat 130, 184
 wheel 198, 207
 wheel nuts 203
 wheelbarrow 88
 wheelchair 48
 wheelchair access 197
 whiplash 46
 whipped cream 137
 whisk 68
 whisk v 67
 whiskers 290
 whisky 145
 white 39, 145, 272, 274
 white bread 139
 white chocolate 113
 white coffee 148
 white currant 127
 white flour 138
 white meat 118
 white rice 130
 white spirit 83
 whiting 120
 whole 129, 132
 whole milk 136
 wholegrain 131
 wholegrain mustard 135
 wholemeal bread 139
 wholemeal flour 138
 wicket 225
 wicket-keeper 225
 wide 321
 widescreen television 269
 width 165
 wife 22
 wig 39
 wild rice 130
 willow 296
 win v 273
 wind 241, 286
 windbreak 265
 windcheater 33
 windlass 214
 window 58, 96, 98, 177, 186,
 197, 209, 210
 windpipe 18
 windscreen 198
 windscreen wiper 198
 windshield 205
 windsurfer 241

windsurfing 241
 windy 286
 wine 145, 151
 wine glass 65
 wine list 152
 wine vinegar 135
 wing 119, 210, 293
 wing mirror 198
 wings 254
 winner 273
 winter 31, 307
 winter sports 247
 wipe v 77
 wire 79
 wire cutter 80
 wire strippers 81
 wire wool 81
 wires 60
 with 320
 withdrawal slip 96
 without 320
 witness 180
 wok 69
 wolf 290
 woman 23
 womb 52
 women's clothing 34
 women's wear 105
 wood 79, 233, 275, 285
 wood glue 78
 wood shavings 78
 wooden spoon 68
 woodpecker 292
 woodstain 79
 woodwind 257
 woodworking 275
 wool 277
 work 172
 work day 306
 workbench 78
 workshop 78
 worktop 66
 world map 312
 worm 295
 worried 25
 wound 46
 wrap 155
 wrapping 111
 wreath 111
 wrench 81, 203
 wrestling 236
 wrinkle 15
 wrist 13, 15
 wristband 230
 writ 180
 write v 162

X

x-ray 48
 x-ray film 50
 x-ray machine 212
 x-ray viewer 45

Y

yacht 215, 240
 yam 125
 yard 310
 yawn v 25

year 163, 306
 yeast 138
 yellow 274
 yellow card 223
 Yemen 318
 yes 322
 yesterday 306
 yoga 54
 yoghurt 137
 yolk 137, 157
 you're welcome 322
 Yugoslavia 316

Z

Zambia 317
 zebra 291
 zero 308
 zest 126
 Zimbabwe 317
 zinc 289
 zip 277
 zone 315
 zones 283
 zoo 262
 zoology 169
 zoom lens 270

鸣谢 míngxiè • acknowledgments

DORLING KINDERSLEY would like to thank Tracey Miles and Christine Lacey for design assistance, Georgina Garner for editorial and administrative help, Sonia Gavira, Polly Boyd, and Cathy Meeus for editorial help, and Claire Bowers for compiling the DK picture credits.

The publisher would like to thank the following for their kind permission to reproduce their photographs:
Abbreviations key:

t = top, b = bottom, r = right, l = left, c = centre

Abode: 62; **Action Plus:** 224bc; **alamy.com:** 154t; A.T. Willett 287bcl; Michael Foyle 184bl; Stock Connection 287bcr; **Allsport/Getty Images:** 238cl; **Alvey and Towers:** 209 acr, 215bcl, 215bcr, 241cr; **Peter Anderson:** 188cbr, 271br. **Anthony Blake Photo Library:** Charlie Stebbings 114cl; John Sims 114tcl; **Andyalte:** 98tl; **apple mac computers:** 268tr; **Arcaid:** John Edward Linden 301bl; Martine Hamilton Knight, Architects: Chapman Taylor Partners, 213cl; Richard Bryant 301br; **Argos:** 41tcl, 66cbl, 66cl, 66br, 66bcl, 69cl, 70bcl, 71t, 77t, 269tc, 270tl; **Axiom:** Eitan Simanor 105bcr; Ian Cumming 104; Vicki Couchman 148cr; **Beken Of Cows Ltd:** 215bcb; **Bosch:** 76tcr, 76tc, 76tcl; **Camera Press:** 27c, 38tr, 256t, 257cr; Barry J. Holmes 148tr; Jane Hanger 159cr; Mary Germanou 259bc; **Corbis:** 78b; Anna Clopet 247tr; Bettmann 181tl, 181tr; Bo Zauders 156t; Bob Rowan 152bl; Bob Winsett 247cbl; Brian Bailey 247br; Carl and Ann Purcell 162l; Chris Rainer 247ctl; ChromoSohm Inc. 179tr; Craig Aurness 215bl; David H. Wells 249cbr; Dennis Marsico 274bl; Dimitri Lundt 236bc; Duomo 211t; Gail Mooney 277ctcr; George Lepp 248c; Gunter Marx 248cr; Jack Fields 210b; Jack Hollingsworth 231bl; Jacqui Hurst 277cbr; James L. Ams 247bl, 191ctr, 220bcr; Jan Butchofsky 277cbr; Johnathan Blair 243cr; Jon Feingersh 153tr; Jose F. Poblete 191br; Jose Luis Pelaez.Inc 153tc, 175tl; Karl Weatherly 220bl, 247cr; Kelly Mooney Photography 259tl; Kevin Fleming 249bc; Kevin R. Morris 105tr, 243tl, 243tc; Kim Sayer 249tcr; Lynn Goldsmith 258t; Macduff Everton 231bcl; Mark Gibson 249bl; Mark L. Stephenson 249tcl; Michael Pole 115tr; Michael S. Yamashita 247ctcl; Mike King 247cbl; Neil Rabinowitz 214br; Owen Franken 112t; Pablo Corral 115bc; Paul A. Saunders

169br, 249ctcl; Paul J. Sutton 224c, 224br; Peter Turnley 105tcr; Phil Schermeister 227b, 248tr; R. W. Jones 309; R.V. Jones 175tr; Richard Hutchings 168b; Rick Doyle 241ctr; Robert Holmes 97br, 277ctc; Roger Ressimeyer 169tr; Russ Schleipman 229; Steve Raymer 168cr; The Purcell Team 211ctr; Tim Wright 178; Vince Streato 194t; Yann McNamee 220br, 220bcl, 224bl; Yann Arhus-Bertrand 249tl;

Demetrio Carrasco / Dorling Kindersley (c) Herge / Les Editions Casterman: 112ccl; **Dixons:** 270cl, 270cr, 270bl, 270bcl, 270bcr, 270ccr; **Education Photos:** John Walmsley 26tl; **Empics Ltd:** Adam Day 236br; Andy Heading 243c; Steve White 249cbc; **Getty Images:** 48bcl, 100t, 114bcr, 154bl, 287tr; 94tr; **Dennis Gilbert:** 106tc; **Hulsta:** 70t; **Ideal Standard Ltd:** 72r; **The Image Bank/Getty Images:** 58; **Impact Photos:** Eliza Armstrong 115cr; John Arthur 190tl; Philip Achache 246t; **The Interior Archive:** Henry Wilson, Alfie's Market 114bl; Luke White, Architect: David Mikhail, 59tl; Simon Upton, Architect: Philippe Starck, St Martins Lane Hotel 100bcr, 100br; **Jason Hawkes Aerial Photography:** 216t; **Dan Johnson:** 26cbl, 35r; **Kos Pictures Source:** 215cbl, 240tc, 240tr; David Williams 216b; **Lebrecht Collection:** Kate Mount 169bc; **MP Visual.com:** Mark Swallow 202t; **NASA:** 280cr, 280ccl, 281tl; **P&O Princess Cruises:** 214bl; **P A Photos:** 181br;

The Photographers' Library: 186bl, 186bc, 186t; **Plain and Simple Kitchens:** 66t; **Powerstock Photolibrary:** 169tl, 256t, 287tc; **Rail Images:** 208c, 208 cbl, 209br; **Red Consultancy:** Odeon cinemas 257br; **Redferns:** 259br; Nigel Crane 259c; **Rex Features:** 106br, 259tc, 259tr, 259bl, 280b; Charles Ommaney 114tcr; J.F.F Whitehead 243cl; Patrick Barth 101tl; Patrick Frilet 189cbl; Scott Wiseman 287bl; **Royalty Free Images:** Getty Images/Eyewire 154bl; **Science & Society Picture Library:** Science Museum 202b; **Skyscan:** 168t, 182c, 298; Quick UK Ltd 212; **Sony:** 268bc; **Robert Streeter:** 154br; **Neil Sutherland:** 82tr, 83tl, 90t, 118, 188ctr, 196tl, 196tr, 299cl, 299bl; **The Travel Library:** Stuart Black 264t; **Travelex:** 97cl; **Vauxhall:** Technik 198t, 199tl, 199tr, 199cl, 199cr, 199ctcl, 199ctcr, 199tcl, 199tr, 200; **View Pictures:** Dennis Gilbert, Architects: ACDP Consulting, 106t; Dennis Gilbert,

Chris Wilkinson Architects, 209tr; Peter Cook, Architects: Nicholas Crimshaw and partners, 208t; **Betty Walton:** 185br; **Colin Walton:** 2, 4, 7, 9, 10, 28, 42, 56, 92, 95c, 99tl, 99tcl, 102, 116, 120t, 138t, 146, 150t, 160, 170, 191ctcl, 192, 218, 252, 260br, 260l, 261tr, 261c, 261cr, 271cbl, 271cbr, 271ctl, 278, 287br, 302, 401.

DK PICTURE LIBRARY:

Akhil Bahkshi; Patrick Baldwin; Geoff Brightling; British Museum; John Bulmer; Andrew Butler; Joe Cornish; Brian Cosgrove; Andy Crawford and Kit Houghton; Philip Dowell; Alistair Duncan; Gables; Bob Gathany; Norman Hollands; Kew Gardens; Peter James Kindersley; Vladimir Kozlik; Sam Lloyd; London Northern Bus Company Ltd; Tracy Morgan; David Murray and Jules Selmes; Musée Vivant du Cheval, France; Museum of Broadcast Communications; Museum of Natural History; NASA; National History Museum; Norfolk Rural Life Museum; Stephen Oliver; RNL; Royal Ballet School; Guy Ryeart; Science Museum; Neil Setchfield; Ross Simms and the Winchcombe Folk Police Museum; Singapore Symphony Orchestra; Smart Museum of Art; Tony Souter; Erik Svensson and Jeppe Wikstrom; Sam Tree of Keygrove Marketing Ltd; Barrie Watts; Alan Williams; Jerry Young.

Additional Photography by Colin Walton.

Colin Walton would like to thank: A&A News, Uckfield; Abbey Music, Tunbridge Wells; Arena Mens Clothing, Tunbridge Wells; Burrells of Tunbridge Wells; Gary at Di Marco's; Jeremy's Home Store, Tunbridge Wells; Noakes of Tunbridge Wells; Ottakar's, Tunbridge Wells; Selby's of Uckfield; Sevenoaks Sound and Vision; Westfield, Royal Victoria Place, Tunbridge Wells.

All other images are Dorling Kindersley copyright. For further information see www.dkimages.com